

German Red Cross

Emergency Response Units

Item Specifications

General Requirements for Shipping, Packing and Labelling of Emergency Response Unit Items

Shipping:

Delivery is made exclusively on new Euro pallets which meet the IPPC standard.

As a rule, single items must not exceed a packing size of 80 x 120 cm.

Items must be ready to use but also optimized to reduce shipping volume (e.g. tiltable or demounted handles for pumps or generators)

Packing:

As a rule, items which are part of a kit (e.g. MAJOR TRAUMA BACKPACK KIT) must be delivered as a prepacked kit with appropriate/specified casing and contents list featuring expiry dates if applicable. In general, environmentally friendly packaging material must be used economically.

Labelling:

Each pallet/parcel must be labelled at least with:

- GRC code
- Inventory number (for orders/replacement of expired items)
- GRC purchase order number

Accompanying Documents:

If the nature of the items so requires, further documents (e.g. quality or origin certificates, warranty certificates, safety data sheets) have to be enclosed with the delivery.

Medical or technical devices must always be accompanied by printed operating instructions in German and English. These must also be made available in a digital form/soft copy in the appropriate data format (*.pdf, *.docx, *.xlsx).

Expiry dates of items must be mentioned in the shipping documents and where applicable in the packing lists.

Standards/Certifications:

All items must have CE marking that indicates conformity with health, safety, and environmental protection standards for products sold within the European Economic Area (EEA).

All items must be ready to use (e.g. engines filled with oil), meet the EU-OSHA occupational safety and health standards and must be designed considering user comfort (e.g. a health worker's wearing duration of PPE is 8 – 12 hours).

0001 (body bag) PAD, ABSORBENT, adult, child

Highly Fluids Absorbent disposable sheet, lining for body bag, used to absorb body fluids in case of contagious infectious disease (haemorrhagic fever, cholera...) Position first the absorbent pad on the whole surface of the body bag before placing the body.

Technical specifications

Pad made of compressed powder

Absorbent on both sides (no waterproof layer at the top or bottom)

Absorption capacity:

adult size: 20 litres water/ 11 litres of NaCl (equivalent to body fluids)

child size: 12 litres water/ 6 litres of NaCl

Dimensions

Adult size: 200 x 60 cm

Child size: 130 x 40 cm

Absorption capacity: min. 5 liters

. Resistant to 0.5% chlorine solution

. Color: white

. Size: approx. 150 x 75 cm

Single use purpose

. Shelf life: Min. 5 years



0002 ANTI-FOG SPRAY, for goggles

Anti-fog spray for goggles

Nanotechnology: high-quality sealing/impregnation

environmentally friendly: water-based, without toxic/hazardous content



0003 VENTURI MASK KIT, adult, non-sterile, disposable

Adult, non-sterile, single use only, aerosol mask with venturi valves providing:

- Soft chin, nose and side seals for patient comfort
- Chin seal for under or over chin positions - better fit for a wider range of patient face shapes
- Incurved nose seal to prevent oxygen and aerosolised drugs entering the patient's eyes
- No metal nose clip - MRI compatible
- Elasticity to be positioned under or over the ears

Dimensions, weight and materials:

	Mask	Oxygen tubing	Limb & connector	Cup	Venturi valves
Weight (g)		33	14	10	5
Width (mm)	100				26
Height / Length (mm)	125	1800	150		65
Approx. dead space (ml)	139				
Materials	TPE	PVC	LDPE	PP	PP
	PP		PP		
	Elastic				

Venturi valves:

Colour	Blue	White	Orange	Yellow	Red	Green
O2 concentration (%)	24	28	31	35	40	60
Recommended O2 flow (l/min)	2	4	6	8	10	15
Total flow to patient (l/min)	53	45	47	43	42	30

Certification:
CE0120 Class 2A

Applicable Standards:

BS EN ISO 13485: Medical devices — Quality management systems — Requirements for regulatory purposes

ISO 9001: Quality Management Systems – Requirements

ISO 15223-1: Medical Devices - Symbols to be Used with Medical Device Labels, Labelling, & Information to be Supplied

BS EN 13544-2: Respiratory therapy equipment – Tubing and connectors

BS EN ISO 5356-1: Anaesthetic and respiratory equipment. Conical connectors. Cones and sockets

BS EN 13544-3: Respiratory Therapy Equipment: Part 3: Air entrainment devices

Shelf life: min. 5 years



0004a BODY BAG, infectious disease, white, 6 grips, adult, 2.5x1.2m, 300um

Bag used for packing and transporting contagious human corpses

100% leak-free body bag

Color: White

Special liner reinforced material (2plies)

Size: 2500 x 1200mm

Thickness: 300micron

2 weldings over length 50mm from side

Zipper U-shape: zipper completely free with 2 runners with tie rip loops on each runner

6 non splintering handles

Non-PVC and Non-degradable

Biodegradable: no

In the ground the body bag will remain solid for a period between 7 to 10 years

Shelf life: 10 years



0004b BODY BAG, infectious disease, black, 6 grips, adult, 2.5x1.2m, 300um

Bag used for packing and transporting contagious human corpses

100% leak-free body bag

Color: Black

Special liner reinforced material (2plies)

Size: 2500 x 1200mm

Thickness: 300micron

2 weldings over length 50mm from side

Zipper U-shape: zipper completely free with 2 runners with tie rip loops on each runner

6 non splintering handles

Non-PVC and Non-degradable

Biodegradable: no

In the ground the body bag will remain solid for a period between 7 to 10 years

Shelf life: 10 years

0005a BODY BAG, infectious disease, white, 6 grips, child, 1.5x1.0m, 300um

Bag used for packing and transporting contagious human corpses

100% leak-free body bag

Color: White

Special liner reinforced material (2plies)

Size: 1500 x 1000mm

Thickness: 300micron

2 weldings over length 50mm from side

Zipper U-shape: zipper completely free with 2 runners with tie rip loops on each runner

6 non splintering handles

Non-PVC and Non-degradable

Biodegradable: no

In the ground the body bag will remain solid for a period between 7 to 10 years

Shelf life: 10 years



0005b BODY BAG, infectious disease, white, 6 grips, child, 1.5x1.0m, 300um

Bag used for packing and transporting contagious human corpses

100% leak-free body bag

Color: Black

Special liner reinforced material (2plies)

Size: 1500 x 1000mm

Thickness: 300micron

2 weldings over length 50mm from side

Zipper U-shape: zipper completely free with 2 runners with tie rip loops on each runner

6 non splintering handles

Non-PVC and Non-degradable

Biodegradable: no

In the ground the body bag will remain solid for a period between 7 to 10 years

Shelf life: 10 years

0006 BOOTS, rubber, white, pair, size 39

0006a BOOTS, rubber, white, pair, size 38

0007 BOOTS, rubber, white, pair, size 40

0007a BOOTS, rubber, white, pair, size 42

0008 BOOTS, rubber, white, pair, size 44

0008a BOOTS, rubber, white, pair, size 46

0009 BOOTS, rubber, white, pair, size 48

0009a BOOTS, rubber, white, pair, size 52

0009b BOOTS, rubber, white, pair, size 54

OT-boots, white/grey, according to EN347 and ISO6112



0010 CBRN PROTECTIVE TAPE, 25m roll, yellow

- 25 meter roll
- 5 cm wide
- patented chemical resistant tape
- excellent chemical barrier protection
- for taping asseciores like gloves and boots to suits
- for tightening leakages
- tested to the breakthrough of various aggressive chemicals
- the necessary addition in usage of chemically protection suits and gloves

Colour: yellow



- 0011 COVERALL, PROTECTIVE, Tychem C, hooded, yellow, size L**
- 0012 COVERALL, PROTECTIVE, Tychem C, hooded, yellow, size M**
- 0013 COVERALL, PROTECTIVE, Tychem C, hooded, yellow, size XL**
- 0013a COVERALL, PROTECTIVE, Tychem C, hooded, yellow, size XXL**
- 0013b COVERALL, PROTECTIVE, Tychem C, hooded, yellow, size XXXL**
- 0014 COVERALL, PROTECTIVE, Tychem C, hooded, yellow, size S**

Personal protective equipment that fully covers the wearer's body from head to ankles. Intended to be worn over a surgical tunic and trousers to protect medical and non-medical staff from exposure to inorganic chemicals and infective biological agents (e.g. Ebola).

Specifications

Manufacturer: DuPont Tychem C, CHA5®

Norms

Disposable coverall against biological hazards (EN14126) - according to EN13982-1 type 5, EN13034 type 6, EN14605 type 4, personal protection equipment category III according to European legislation or equivalent US legislation

Protective clothing (PPE) Category III complex design:

Chemical protective clothing Types 3, 4, 5, 6

Protective clothing against infective agents Type 3B (liquid tight) and/or 4B (spray tight)

Meets the following European standards requirements:

EN 340: 2003 Protective clothing, general requirements

Norms applicable to the fabric :

EN 368/EN ISO 6530: Resistance of materials to penetration by chemicals liquid

EN 14126: 2005. Protection against infective agents from risk groups 1,2,3,4

ISO 16603 : Determination of the resistance of

protective clothing materials to penetration by blood and

body fluids, test method using synthetic, under hydrostatic = 20 kPa - Class 6/6

ISO 16604 : Determination of resistance of protective

clothing materials to penetration by blood-borne

pathogens, test method using Phi-X 174 bacteriophage, under hydrostatic = 20 kPa -

Class 6/6

ISO 22612 : Test method for resistance to dry microbial (bacteria) penetration = $\log \text{cfu} \leq 1$ - Classe 3
ISO 22611 : Test method for resistance to penetration by biologically contaminated aerosols, using *Staphylococcus aureus* = $\log \text{ratio} > 5$ - Class 3/3
ISO 22610 : Test method to determine the resistance to wet bacterial penetration, when subjected to mechanical rubbing = $> 75 \text{ min}$ - Classe 6/6
EN 14325 : 2004 : Test methods and performance classification of chemical protective clothing materials, seams, joins and assemblages
Abrasion resistance: $> 2000 \text{ cycles}$ /Class 6 of 6
Flex cracking resistance: $> 100\,000 \text{ cycles}$ /Class 6 of 6
Trapezoidal tear resistance: at least Class 3 of 6
Tensile strength (max. tear): Class 2 of 6
Puncture resistance: Class 2 of 6
Resistance to ignition: at least Class 1 of 3

Norms applicable to the whole coverall

EN 1073-2 : 2002 : Requirements and test methods for non-ventilated protective clothing against particulate radioactive contamination = Class 1/3
EN 1149-5 & EN 1149-1 : Electrostatic properties = Class 2
EN ISO 13935-2 : 2004 : Determination of maximum force to seam rupture using the grab method = $> 125 \text{ N}$, level 4/6
EN 14605 : 2005 : Protective clothing Types 3-4: Protection against liquid chemicals (spray-tight)
ISO 17491-3 : 2008 : Test methods for clothing providing protection against chemicals - Part 3: Determination of resistance to penetration by a jet of liquid (jet test) = pass
ISO 17491-4 : 2008 : Test methods for clothing providing protection against chemicals - Part 4: Determination of resistance to penetration by a spray of liquid (spray test) = pass
EN ISO 13982-1 : 2004 : Performance requirements for chemical protective clothing providing protection to the full body against airborne solid particulates (type 5 clothing) = pass
EN 13034 : 2005 : Performance requirements for chemical protective clothing offering limited protective performance against liquid chemicals (type 6 clothing) = pass

Technical specifications

Substrate of Tyvek® fabric (spunbonded olefin sheet made of high density polyethylene fibres) with additional polymeric coating
Particle tight and waterproof fabric
Stitched and taped seams for better seam strength and to makes it completely leak-proof and waterproof
Elastic thumb-loops latex-free attached to the end of the sleeves
Zipper: nylon on polyester braid with self-adhesive protective flap
Lint-free, latex-free, halogen compounds-free
Elastic integrated hood with self-adhesive chin flap
Elastic cuffs and ankles
Elastic waist
With loops for thumb
Thickness: $180 \mu\text{m}$
Colour: yellow
Unit presentation, non sterile, for single use



0015 DRAWSHEET, disposable, plastified, absorbable, ca. 60 x 60 cm

Small disposable protection sheet made of one absorbent side and one watertight side. It is used to protect the bed linen during treatments.

Specifications

Material : cellulose with a layer in polyethene (PE)

Technical specifications

- Size: +/- 60 x 60 cm
- 1 watertight plastic side
- 1 absorbant side made of cellulose
- Non sterile, disposable

Packaging: depends on the brand by 28, 50, 100 etc.but never by piece
Personal protective equipment



0016 GLOVE, EXAMINATION, nitrile, extended cuff, non sterile, L

0016a GLOVE, EXAMINATION, nitrile, extended cuff, non sterile, XL

0016b GLOVE, EXAMINATION, nitrile, extended cuff, non sterile, XXL

0017 GLOVE, EXAMINATION, nitrile, extended cuff, non sterile, M

0018 GLOVE, EXAMINATION, nitrile, extended cuff, non sterile, S

Non sterile glove with extended cuff used to protect both patient and staff from infections transmitted through contact with the hands.

Nitrile, non-sterile, ambidextrous, disposable; semisolid; high quality; powder-free; cuff edge straight or rolled; according to EN 455-1-2-3-4/2001-2007-2009, and Directives 93/42/EC class I

Specifications

Norms

- EN 455-1: 2001 "Medical gloves for single use - Requirements and testing for freedom from holes." AQL = 1.5
- EN 455-2: 2009 + A2: 2013 "Medical gloves for single use - Requirements and testing for physical properties" Force at break $\geq 6N$ before and after ageing.
- EN 455-3: 2007 "Medical gloves for single use -Requirements and testing for biological evaluation"
- EN 455-4: 2009 "Medical gloves for single use - Part 4: Requirements and testing for shelf life determination"
- EN 374-2: 2015 "Protective gloves against dangerous chemicals and microorganisms - Part 2: Determination of resistance to penetration" Edition: 3. AQL = 1.5

Technical specifications

- 100% nitrile, non powdered
- Ambidextrous shape (fits either hand)
- Thickness at fingers: max 0.1 mm
- Cuff: extended with straight edge
- Colour : blue or purple
- Non sterile, for single use

Dimensions

5 sizes: small (S), medium (M), large (L), x-large (XL) and xx-large (XXL)

Size	Minimum length	Palm width
small	290 mm	85 ± 5 mm
medium	290 mm	95 ± 5 mm
large	290 mm	105 ± 5 mm
x-large	290 mm	115 ± 5 mm
xx-large	290 mm	> 120 mm

Packaging

Cardboard distribution box of 50 or 100 gloves.



0019 GLOVES, PROTECTIVE, nitrile, reusable, size 10/XL

0019a GLOVES, PROTECTIVE, nitrile, reusable, size 11/XXL

0020 GLOVES, PROTECTIVE, nitrile, reusable, size 7/S

0021 GLOVES, PROTECTIVE, nitrile, reusable, size 8/M

0021a GLOVES, PROTECTIVE, nitrile, reusable, size 9/L

Pair of high-comfort and chemical resistant heavy-duty gloves

- Cotton flocking, reducing sweat for the wearer
 - Fully reusable, with an unequaled abrasion resistance
 - Provides superb comfort for the wearer
 - Reversed lozenge finish further enhancing levels of grip
- High performance nitrile compound, providing an outstanding combination of chemical resistance and strength for optimal results in wet or dry work environments
 - The glove offers a far superior snag, puncture and abrasion protection compared with rubber or neoprene gloves
 - High levels of flexibility, comfort and dexterity
 - Will not swell, weaken or degrade, and does not promote contact dermatitis
 - Suitable for heavy-duty cleaning applications

Standards/Certifications:

- EN 420:2003 + A1:2009; 0493
- conforms to EC 89/686/EEC, Category III: EN 374, -2, 3, 4, EN 420 and EN 388 (High cracking-, puncture- and abrasion resistant, levels: $\geq 4-1-0-1$) or equivalent standards

Material:

- Nitrile
- Minimum length: 380 mm
- Left/right pair
- Knit inner lining to facilitate slide-in and removal
- Thickness: $\geq 0,425$ mm
- Cleanable with water and disinfectant (resisting both ethanol solutions 70% and chlorine solutions $>0.5\%$)

Available in sizes: S (7), M (8), L (9), XL (10) and XXL (11)



0022 GOGGLES, PROTECTIVE, wraparound, with anti-fog coating

Safety wraparound goggles which protect the eyes from dust and splashing in VHF contexts.

Norms

- Directive 89/686/EEC on personal protective equipment (PPE)
- EN 166/2002: "Personal eye-protection - Specifications"

Technical specifications

- Replaceable clear lens in acetate
- Optic class 2 according EN166 = applicable for intermittent use
- Ocular treated against fogging and scratches
- Panoramic lens 180°
- Easy to combine with corrective glasses
- PVC mask
- Broad and fully adjustable head band
- Indirect ventilation all around the mounting
- Anti-fog coating
- Supple face mounting enabling the mask to fit all kind of faces without exerting too high pressures
- Minimal mechanical resistance = resistance to shocks of low-energy particles (withstands a bead of 6 mm and 0.86 g at 45m/s impact)

Colourless, gas tight/non-ventilated; eye protection with polycarbonate lens, neopropene body, elastic strap



0023 GOWN, SURGICAL, nonwoven, M

0024 GOWN, SURGICAL, nonwoven, XL

Protective clothing worn by operating theatre staff over a surgical tunic and surgical trousers in order to prevent transmission of infectious agents.

Specifications

Norms

according to ISO22610 and ISO22612

EN 13795+A1: 2013 "Surgical drapes, gowns and clean air suits, used as medical devices for patients, clinical staff and equipment - General requirements for manufacturers, processors and products, test methods, performance requirements and performance levels", edition: 4

Technical specifications

- Nonwoven (SMS or SMMS [Spunbond-Meltblown-Spunbond])
- Impervious supplementary protection layer (polyethylene film, nonwoven, etc.) in the critical zones (chest area and forearms)
- Wraparound
- Long sleeves
- Cuffs made of elastic jersey
- Latex-free
- Sterile, for single use

Dimensions

- Comes in 3 sizes: Large, XLarge and XXLarge.
- Length (shoulder seam to mid calf):
 - o size Large: ± 130 cm
 - o size XLarge: ± 150 cm
 - o size XXLarge: ± 160 cm

Packaging

- Unit presentation with reverse folding in order to ensure an aseptic gowning technique
- Wrapped in a drape
- Double sterile packaging in peel-open pack



0025 HOOD, Tyvek, with mask, non-woven

Must cover shoulders entirely; ties at back of the head, neck and underneath arms

Fabric

- EN14126 with level $\geq 4/6$ for test ISO 16603 and preferably level $\geq 4/6$ for test ISO 16604
- o sewed and covered (=sealed) or welded with ultrasounds

Form/design :

- Must cover shoulders entirely; ties at back of the head, neck and underneath arms
- o 3 pairs of straps to tighten for fixation behind the head
- o 1 or 2 pairs of straps for fixation at the height of the torso

- o With integrated mask
- Non sterile, for single use
- Unit presentation



0026 Mirror stand



Ca. 25cmx40cm

0027 Mirror Standard



ca. 45X50cm

0028 RESPIRATOR, FFP3, disposable, duck bill, w/o valve

Filtering device covering nose, mouth and chin, used to protect the wearer against airborne or droplets transmitted infectious agents.

High fluid resistance, good breathability, internal and external faces should be clearly identified, structured design that does not collapse against the mouth.

FFP3 without valve; safe high-risk-mask, duck bill; particle filtration efficiency PPE (0,1 micron)>99%, bacterial filtration efficiency (0,3 micron)>99%

FFP3 must be written on the respirator itself

Norm EN 149:2001+A1:2009



0028a RESPIRATOR, FFP3, disposable, duck bill, with valve

Filtering device covering nose, mouth and chin, used to protect the wearer against airborne or droplets transmitted infectious agents.

High fluid resistance, good breathability, internal and external faces should be clearly identified, structured design that does not collapse against the mouth.

FFP3 with valve; safe high-risk-mask, duck bill; particle filtration efficiency PPE (0,1 micron)>99%, bacterial filtration efficiency (0,3 micron)>99%

FFP3 must be written on the respirator itself

Norm EN 149:2001+A1:2009



0029 TROUSERS, non-sterile, woven, L DISPOSABLE

0030 TROUSERS, non-sterile, woven, M DISPOSABLE

0031 TROUSERS, non-sterile, woven, S DISPOSABLE

0032 TROUSERS, non-sterile, woven, XL DISPOSABLE

Disposable scrub pants are available with a drawstring waist or elastic waist.

Made from breathable, fluid resistant multi-layer material.

Pants have one rear pocket.

abric Type	Breathable Mutli-Layer Fluid R
HPIS CLASSIFICATION	760_20_110_10
Latex Free	Yes
Length	Regular
MATERIAL	Medium Weight Multi-Ply



0033 TUNIC, non-sterile, woven, L DISPOSABLE

0034 TUNIC, non-sterile, woven, M, DISPOSABLE

0035 TUNIC, non-sterile, woven, S, DISPOSABLE

0036 TUNIC, non-sterile, woven, XL DISPOSABLE

Disposable scrub shirts are available with a round neck.
Made from breathable, fluid-resistant multi-layer material.
Feature one chest pocket



0037 BANDAGE, EXTENSIBLE, non-adhesive, 6 to 7 cm x 4 m

Stretch bandage used to secure dressings.

Specifications

Technical specifications

- Polyamid, viscose, cotton
- Elasticity: 90-110 %
- With selvages
- Roll presentation
- Non sterile

Dimensions

- Width: 7 ± 1 cm
- Length: ± 4 m

0038

0039 BLANKET, SURVIVAL, 220 x 140 cm, thickness 12 microns



0040 BOX ISOTHERM, triple pack., infectious substance UN2814

Box with UN approved triple packaging system, used for the transport of CATEGORY A samples, i.e. infectious substance, affecting humans.

NB: All the pathogenic agents cultures are included in this category.

Isotherm box, allowing to keep the samples between 2° and 8° C for 72 h, with 2 or 4 icepacks.

Meets the packaging instructions 602.

(Cf Procedures for transporting samples)

The system consists of 3 layers:

1. Primary container

Tube or vial containing the sample (MAXIMUM 50 ml !)

Hermetic seal (if necessary, fix the cap with some adhesive tape) and to be labelled with a permanent marker

2. Secondary container

Watertight polyethylene cylinder box intended to protect the primary container

Screw cap with gasket

Supplied with:

bubble paper vial holder in which several primary containers can be placed

a sheet of absorbent can absorb all the fluid in case of breakage

+/- Ø 12.5 cm, H 15 cm

Maximum volume: 1.8 litre

3. Outer container

Strengthened cardboard box used to protect the secondary container

Insulation: inner molded polystyrene box

Labelling UN 2814

Designed to hold 4 icepacks 0.4 l or 2 icepacks of 0.6 l
Approx. 40 x 35 x 30 cm

Mandatory minimum packaging for any sample in case of suspicion of:

Multi drug resistance tuberculosis: cultures

Rabies (piece of animal, brain sample in a hermetically sealed plastic bag)

Viral Haemorrhagic Fever (whole blood in plain tube or EDTA)

The total quantity of sample must not exceed 50 ml.

Boxes that transported infectious substances must not be reused.

Transport of samples

Infectious substances 2814 are refused by DHL and must be shipped by World Courier or air transport.



0041 **BRACELET, IDENTIFICATION (Ident-A-Band), feeding cent, white**

Used for patient identification in a hospital or medical treatment centre; worn on the wrist.
omponents & materials:

- Bracelet: transparent polyethylene.
- Insert card: cardboard strip.
- Pressure fastener: (stud type) metal.

Description:

- Ident-A-Band brand, size suitable for children and adults: length 23cm, width 1cm.
- Bracelet: flat and tubular with smooth edges.
- Transparent, colour-coded: red for therapeutic feeding, green or blue for supplementary feeding.
- Insert card, water-resistant, accomodates 2 lines of information.
- Safe and secure metal fastener.
- Tamperproof.
- Flexible, comfortable, non-stretch.

Unit presentation:

1 bracelet with 1 insert card, single-use.

Packaging:

400 bracelets and insert cards in a carton, including multilingual user instructions.

Labelling:

Product description, size, reference number, manufacturer's name and address.

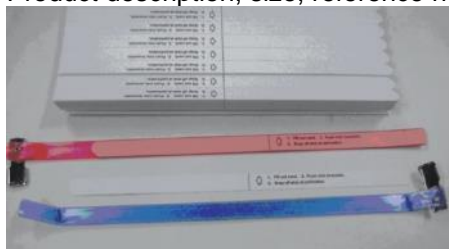

0042 CONTAINER , needles recovery 1 l , plastic

TRBA 250

disposal container for safe disposal of used scalpels, needles and other medical instruments.

For contact-free disposal of sharp and pointed objects

Holder for protective caps from Penkanülen

Closure: reclosable, irreversibly closed for disposal

Puncture Safe, stable, unbreakable

Level control visible

Corresponds to the TRBA and intern. Standards

Material: Polypropylene

Color: container knows Info tag yellow

Ca 1-2l



0043 CONTAINER, PROTECTION, transport of sample, plastic, 30 mm

Cylindrical container with absorbent material and screw cap, used to transport tubes containing samples (minimum requirement!). Screw cap

Absorbent liner (can absorb up to 600 ml)

Dimensions: H 126 mm x Ø 30 mm or 44 mm



0044 Container, Sample, Plast., 60ml, Non Sterile, Urine

Transparent bottle with screw cap, used for urine or stool samples.

Bottle: polystyrene crystal (PS) or polypropylene (PP).

Technical specifications

Capacity: 50 to 60 ml

Non graduated

Single use

0045 Container, Sample, Plast., 60ml, Non Sterile, Urine

Materials: 100% hydrophilic cotton, purified, bleached and carded
Description: - Surgical quality
- Hydrophilic absorption coefficient > or = to 23g/of cotton
- Odourless
- Carded fibre, not less than 10mm
- Appreciable resistance when pulled, does not shed a significant quantity of dust when shaken and does not have lot of "Buds".
- Roll of 500gr and 1kg, interleaved with craft paper.
- Not pre-cut
- Not sterile
- Steamed autoclavable at 134°C.

Unit presentation: Net weight: 125g, foiled in zigzag, not sterile.
- 500g, interleaved with craft paper, not sterile.
- 1kg, often two rolls of 500g, not sterile

Individually packaged in suitable protective wrapping (plastic) to protect against humidity.



0046 I.V. Cannula fixation dressing

Cannula Fixer Elastic Bandage Dressing designed to secure the catheter in challenging I.V. Application.

Sterile / Disposable / Individual Packed /
9 x 6 cm

Breathable fleece material
Slit to wrap around tubing
Extra pad for cushioning



0047 I.V. Cannula fixation strip

Pflastersets, Hautfarbene Heftpflasterstreifen, von Lohmann, Hautfarbene Heftpflasterstreifen aus 100 % Viskose zur Befestigung aller marktüblichen Infusionskanülen und -schläuche

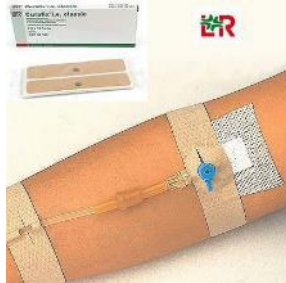

0048 IV CATHETER, Injection Port, S.u. 16G (1,7 x 50mm) grey SAFETY

0049 IV CATHETER, injection port, s.u. 18G (1,3 x 45mm) green SAFETY

0050 IV CATHETER Injection Port, S.u. 20G (1,1 x 33mm) pink SAFETY

0051 IV CATHETER, injection port, s.u. 22G (0,9 x 25mm) blue SAFETY

0052 IV CATHETER, injection port, s.u. 24G (0,51 0,7 x 19mm) yellow SAFETY

Sicherheits-Venenverweilkanüle ISO-Standard 10.555-1/5, EU-Richtlinie 2010/32/EU, TRBA 250

Sicherheits-Venenverweilkanülen, mit integriertem Zuspritzport

_ FEP-Katheter, _ 3-Facetten-Schliff-Geometrie

_ Hydrophobierter Blutfängerstopfen

_ Farbliche Grosenkennzeichnung

16G 196 1,30 1,7 x 50 grey

18G 96 0,96 1,3 x 45 green

20G 61 0,76 1,1 x 33 pink

22G 36 0,61 0,9 x 25 blue

24G* 22 0,51 0,7 x 19 yellow



0064 SYRINGE, s.u., Luer, 1 ml, graduated 1/100 Syringe for insulin, including needle

Syringe (3-part type): Identification: orange (cap and/or marking), international colour code system.

Barrel: Graduations are adapted for insulin concentrations of 100 IU.

Larger graduations every 10 IU (Scale: 0.01ml = 1IU).

Plunger: the end of the plunger head - used as a reference line- must be visible and well defined in order to determine the graduated capacity corresponding to all graduations on the syringe barrel

Needle:Stainless steel, fixed syringe.

Length: 12 to 16mm (27 to 29G).

External Ø maximum 0.45mm (ISO 7864 standard).

Quality requirements: Complies with European Medical Devices Directive, Council Directive 93/42/EEC or equivalent.

- EN-ISO7886-1: Sterile hypodermic syringe for single use: part 1: syringe for manual use

- EN-ISO20594-1: Conical fittings with 6 % (Luer) taper for syringes, needles and certain other medical equipment - Part 1: General requirements

Unit presentation: One syringe, single-use, sterile, individually peel packed

Primary packaging: Labelling: Manufacture's name and/or trademark, product description and reference number, "sterile" with sterilization method, lot number, expiry date by year and month, "for single use", and CE mark and reference number of notifying body. Must be multilingual: English, French and Spanish, others when available.

Secondary packaging:Protected unit, one (1) box 100-unit presentation; labelling is the same as that of the primary packaging.

Number of units per secondary packaging, information for product-specific storage conditions (e.g., temperature, pressure, light, humidity, etc.).

0053 MANDRIN FOR IV CANNULA G 16, grey

0054 MANDRIN FOR IV CANNULA G 18, green

0055 MANDRIN FOR IV CANNULA G 20, pink

0056 MANDRIN FOR IV CANNULA G 22, blue

Mandrin zu Vasofix® Safety

16G 1,7 x 50 50 4219171

18G 1,3 x 45 50 4219120

20G 1,1 x 33 50 4219104

22G 0,9 x 25 50 4215095

Verwendbar für: Vasofix® Safety Sicherer Verschluss des Lumens, Farbliche Größenkennzeichnung Lock-Verriegelung, Latex-frei, PVC-frei



0057 Mini-Spike® Filter

Entnahme- und Zuspritzspike
für Mehrdosenbehälter
0,45-µm-Belüftungsfilter
Schützt vor Raumluftkontamination
Mit 5-µm-Partikelfilter
Blauer Schnappverschluss
Mikrospitze
V (mit Ventil)*



0058 NEEDLE, s.u., Luer, 21 G (0.8 x 38 mm) green, IM SAFETY

0059 NEEDLE, s.u., Luer, 23 G (0.6 x 25mm) blue, SC, IM child SAFETY

0060 NEEDLE, s.u., Luer, G 20, (0,9 x 38 mm), yellow SAFETY

Hypodermic needle
Plastic needle shield added to a syringe (ISO 23908 Sharps), protection features for single-use
In needle-based safety devices, the safety mechanism is built into the needle. The needle can be manually attached to a conventional syringe or a commercially prepared prefilled syringe.

World Health Organization 2015 guideline on the use of safety-engineered syringes
TBRA 250
ISO 23908
20G x 1 1/2" 0,90 x 38 yellow
21G x 1 1/2" 0,80 x 38 green
23G x 1" 0,60 x 25 blue



0061

0062

0063 OXFAM HAND WASHING TAP KIT

Easy to assemble valve with:

Durable, nylon polymer components

Brass, spring loaded, valve closer

Two sealing washers and back nut for mounting on container

Components Included

Line	Quantity	Unit	Description
1	50	Each	Automatic closing valve, with sealing washers and back nut
2	1	Roll(s)	Tape, PTFE
3	1	Each	Hand drill
4	1	Each	Drill bit, hole cutter - to suit adaptor size



0065 THERMOMETER, ELECTRONIC, accuracy 0.1° C + case

Electronically device (without mercury) allowing to measure body temperature in Celsius degrees.

digital thermometer

EN ISO 80601-2-56: 2012 "Medical electrical equipment - Part 2-56: Particular requirements for basic safety and essential performance of clinical thermometers for body temperature measurement" (ISO 80601-2-56:2009)

Technical specifications

Resistant plastic body (ABS type)
Resistant to disinfectant solution, Chlor resistant
Metal tip with temperature sensor of which the electric properties vary according to heat
Liquid cristal display (LCD)
Measurement range: from 35.5° C to 42° C minimum
Accuracy: 0.1° C
Measurement time: 30 to 40 seconds (depending on the model and the site)
Long-life battery: minimum 200 hours (about 1000 measurements)
On/off switch
Automatic shut-off after some minutes
Waterproof
Operating ambient temperature: from +10° C to +35° C minimum
Memory feature is possible, but not mandatory



0066 THERMOMETER COVER, non lubricated, s.u. fr electronic therm.

Softtemp Thermometerhüllen ohne Gleitmittel, digital (1000 Stück)



0067 Tourniquet disposable.

Staubbinde Einweg SARSTAEDT



0068 (disposable) Bed pan (Einweg Bettpfanne).

Ecopatent Einweg Bettpfanne PM-3

Cellulose, Zellstoff, Pulp-Bettpfanne

Bettpfanne aus Zellulose PM-3

Typ: Bettpfanne PM-3 ca. 380 x 310 x (60 – 105) mm

belastbar bis ca. 75 kg (Normalgewicht)/ bis 100 kg zwei ineinander stapelbar (Schwergewicht) / ab 100 kg wird ein Unterstützungsrahmen empfohlen

Undurchlässigkeit für 8 Stunden garantiert

umweltverträglich, hygienisch und wirtschaftlich

Einweg Bettpfanne (Stechbecken, Steckbecken)Stechbecken, Steckbecken

gebrauchsfertige Bettpfanne (Steckbecken, Stechbecken)
100 % Zellstoff Steckbecken, Steckbecken
Zellstoff Qualität : Northern Bleached Softwood Kraft (NBSK), ECF
Gamma hochsterilisierbare Bettpfanne
Macerator friendly
VE (Karton) Gewicht (Stück) 0,105 kg Gewicht (VE) 6,440 kg Gewicht (Palette) 174,560 kg
1 Karton = 55 Stück
1 Palette = 24 Kartons = 1320 Stück
Kleinste Abgabemenge 1 VE = 1 Karton



0069 (disposable) Tablet.

Omni-Pac Meditainer MT-65
Tablett oder Besteckgeschirr Meditainer MT-65
Typ: Meditainer MT-65 ca. 180 x 90 x 19 mm
Stabil umweltverträglich, hygienisch und wirtschaftlich

- Einweg Meditainer
- gebrauchsfertige Meditainer aus 100% Zellstoff
- Zellstoff Qualität : Northern Bleached Softwood Kraft (NBSK), ECF
- Undurchlässigkeit für mehr als 8 Stunden

Macerator friendly
VE (Karton) Gewicht (Stück) 0,009 kg Gewicht (VE) 7,865 kg Gewicht (Palette) 208,760 kg
1 Karton = 800 Stück



0070 (disposable) Urine bottle (einweg Urinflasche).

Urinflasche UB-1 Typ: UB-1 ca. 280 x 140 mm / Öffnung ca. 60 mm / 1300ml Kapazität

- passend in den gängigen Flaschenhalter
- Undurchlässigkeit für mehr als 8 Stunden
- gebrauchsfertige Urinflasche aus 100% Zellstoff
- Einweg Urinflasche
- Zellstoff Qualität : Northern Bleached Softwood Kraft (NBSK), ECF
- umweltverträglich, hygienisch und wirtschaftlich
- Gamma hochstilisierbar

Macerator friendly

VE (Karton) Gewicht (Stück) 0,065 kg Gewicht (VE) 2,288 kg Gewicht (Palette) 70,760 kg

1 Karton = 25 Stück

1 Palette = 24 Kartons = 600 Stück

Kleinste Abgabemenge 1 VE = 1 Karton



0071 Kidney dish Vomit bowl/ (disposable) (Paper Nieren- Brechschale)

ECOPATENT® Recycled Paper Nieren- Brechschale SET-N15000



0072 (disposable) Washing bowl (ECOPATENT® Recycled Paper Waschschüssel)

ECOPATENT® Recycled Paper Waschschüssel SET-EC72449

Seifenbeständige Patientenwaschschüssel

Typ: EC72449 / 4000 ml Kapazität

4000 ml Kapazität

Normen & Richtlinien

Flüssigkeitsbeständig: Britische Norm PAS29:1999

Beständigkeitszeit: >4 Stunden

Beständigkeitstemperatur: 35°C +/- 3°C



0073 Bucket + lit waste water



0074 Chair, plastic

Chlor resistant (0.5%)
Easy to disinfect
Sitzhöhe ca.460mm, Breite 400mm,-Tiefe 420mm,
Red



0079 Shelf nursing ca. 39x85 with 4 box (suspected area)

39x85cm Schubladenregal Schubladen Box Kunststoff Regal mit 4 Kisten Stapelregal
Chlor resistant



0080 Table 40x40 plastic

Plastic ca. 40X40 cm
Chlor resistant (0.5%)
Dient als Beistelltisch Krankenbett,



0081 Table 80x80 plastic

Plastic ca. 80X80 cm
Chlor resistant (0.5%)



0082 Tank round + lid + tap 10 l Plastic for handwashing

Plastic tank with lid and tap
Chlor resistant
With tap and removable screw lid. Extra smooth interior wall for easy cleaning.
Capacity: 10 litres
Ø lid: 12 cm
W x H: 24 x 32 cm



0083 Toilet (Einsitz Trockentoilette)

Cactus-Trockentoiletten Einsitzer, Kunststoff, groß
Höhe: 39,5 cm
Sitzhöhe: 37,5 cm
Breite oben: 38,5 cm
Breite unten: 33 cm
Tiefe oben: 40 cm
Tiefe unten: 33 cm
Gewicht: 2,7 kg
Chlor resistent (0,5%)



0084 Toilet Lidbag

rund, transparent for Single Toilet Cactus-Trockentoiletten (0083) mit Bilamin



0085 Urin bottle holder (Urinflaschenhalter)

Chlor resistent
Urinflaschenhalter ermöglicht Urinflaschen direkt am Pflege-, Krankenbett bereitzustellen.



0086 Washing bowl/basin

Stainless steel
Chlor resistant
Volumen: 6 Liter
Höhe: 15,5 cm
Durchmesser oben- innen: 30cm



0087 Disc-Bed (Folding Cot)

anpassungsfähigste Feldbett, austauschbare Matte
BITTE CHECKEN WELCHE MATTE: CHOLERA OHNE LOCH!!! ???
Flammenresistente & antimikrobiell behandelte Polyester-Matte
600 Denier, hellgraues, weiches und flammenresistentes Polyester mit einer wasserabweisenden, antimikrobiellen Beschichtung. Die nicht-PVC beschichtete Matte kann in der Waschmaschine gewaschen (mit einer verdünnten Chlorklösung) und getrocknet werden. Die Matte ist sehr komfortabel und eignet sich gut für den Gebrauch in Krankenhäusern.

Ultraschallgeschweißte Cholera-Matte

Diese sehr hygienische Matte besteht aus dickem, doppelseitig beschichtetem phthalatfreiem Vinyl. Für maximale Hygiene wurde sie ultraschallgeschweißt mit Verzicht auf Nähte. Die Matte verfügt über ein Loch in der Mitte (20cm Durchmesser für Erwachsene, 10cm für Kinder), ideal zur Behandlung von Cholera- und Ebola-Erkrankten. Die Matte ist komplett undurchlässig und kann zur schnellen Desinfektion mit einer Chlorklösung behandelt werden. Nicht waschmaschinenfest.

Siehe Tabelle für einen guten Überblick.

Technische Spezifikationen:

Silberner, pulverbeschichteter, rostfreier Stahlrahmen

Außenmaße: 208 cm L x 82.5cm B x 55 cm H

Liegefläche: 195 cm L x 70.5 cm B

Höhe des Bettes: 43cm

Packmaße: 85 cm L x 54 cm B x 15 cm H

Gewicht: 15 kg

Belastbarkeit: 226 kg



0088 Infusionsständer

Für alle Disc-Bed-Systeme geeignet.
Infusionsständer in das Loch.
Technische Spezifikationen:
Material: grauer Stahl, rostfrei und pulverbeschichtet
Außenmaße: 103,5 cm x 17 cm x 1,5 cm (L x B x H)
Gewicht: 1 kg

0089 Milk, Infant, Powder, 1st Age, 900 G Tin

0090 Milk, Infant, Powder, 2st Age, 900 G Tin

Different formulas for the 1st and the 2nd age

- from birth until the end of 5th month, which means until the beginning of food diversification (example: NAN1- NIDAL1, Lactogen 1, Nursie 1...)
- from 6th until 12th month (example: NAN2- NIDAL2, Lactogen 2...)

Breast milk substitute formula intended for infants.
Main composition (see MSF)
Partly demineralised whey, vegetable fat (or vegetable oil), skimmed milk powder, malto-dextrin, lactose, emulsifier, vitamins, minerals.
Specifications
These specifications apply to Infant & follow-on formulae manufactured from cows' milk proteins or protein hydrolysates. (amino-acids, lipids... raw material, optional ingredients...) and for specifications for Formulae manufactured from soya protein isolates, or in a mixture with cows' milk proteins.

Nutritional value	<i>minimum</i>	<i>maximum</i>
Energy	250 kJ/100ml	295 kJ/100ml
	60 kcal/100ml	70 kcal/100ml
Proteins	0.45 g/100 kJ	0.7 g/100 kJ
	1.8 g/100 kcal	3 g/100 kcal
	1.08g/100ml	2.1 g/100ml
Lipids	1.05 g/100 kJ	1.4 g/100 kJ
	4.4 g/100 kcal	6.0 g/100 kcal
	2.64 g/100ml	2.64 g/100ml
Carbohydrates	2.2 g/100 kJ	3.4 g/100 kJ
	9 g/100 kcal	14 g/100 kcal
	5.4 g/100ml	9.8 g/100ml
Lactose	1.1 g/100 kJ	-
	4.5 g/100 kcal	-
	2.7 g/100ml	-
Minerals		
Calcium*	12 mg/100 kJ	35 mg/100 kJ
	50 mg/100 kcal	140 mg/100 kcal
	30 mg/100ml	98 mg/100ml
Phosphorus*	6 mg/100 kJ	24 mg/100 kJ
	25 mg/100 kcal	100 mg/100 kcal
	15 mg/100ml	70 mg/100ml
Potassium	14 mg/100 kJ	43 mg/100 kJ
	60 mg/100 kcal	180 mg/100 kcal
	36 mg/100ml	126 mg/100ml

Magnesium	1.2 mg/100 kJ 5 mg/100 kcal 3 mg/100ml	3.6mg/100 kJ 15 mg/100 kcal 10.5 mg/100ml
Sodium	5 mg/100 kJ 20 mg/100 kcal 12 mg/100ml	14 mg/100 kJ 60mg/100kcal 42 mg/100ml
Iron	0.07 mg/100 kJ 0.3 mg/100 kcal 0.18 mg/100ml	0.3 mg/100 kJ 1.3 mg/100 kcal. 0.21 mg/100ml
Zinc	0.12 mg/100 kJ 0.5 mg/100 kcal 0.3 mg/100ml	0.36 mg/100 kJ 1.5 mg/100 kcal 1.05 mg/100ml
Copper	8.4 µg/100 kJ 35 µg/100 kcal 21 µg/100ml	29 µg/100 kJ 120 µg/100 kcal 84 µg/100ml
Iodine	2.5 µg/100 kJ 10 µg/100 kcal 6 µg/100ml	14 µg/100 kJ 60 µg/100 kcal 42 µg/100ml
Manganese	0.25µg/100 kJ 1 µg/100 kcal 0.6 µg/100ml	25 µg/100 kJ 100 µg/100 kcal) 70 µg/100ml
Chloride	12 mg/100 kJ 50 mg/100 kcal 30 mg/100ml	38 mg/100 kJ 160 mg/100 kcal 112 mg/100ml
Fluoride**	-	25 µg/100 kJ 100 µg/100 kcal 70 µg/100ml
Vitamins		
Vitamin A***	14 µg /100 kJ 60 µg /100 kcal 36 µg/100ml	43 µg /100 kJ 180 µg /100 kcal 126 µg/100ml
Vitamin D****	0.25 µg/100 kJ 1 µg/100 kcal 0.6 µg/100ml	0.65 µg/100 kJ 2.5 µg/100 kcal 1.75 µg/100ml
Vitamin E*****	0.12 mg /100 kJ 0.5 mg/100 kcal 0.3 mg/100ml	1.2 mg /100 kJ 5 mg/100 kcal 3.5 mg/100ml
Vitamin C	2.5 mg/100 kJ 10 mg/100 kcal 6 mg/100ml	17 mg/100 kJ 70 mg/100 kcal 49 mg/100ml
Vitamin B1	14 µg /100 kJ 60 µg /100 kcal 36 µg/100ml	72 µg/100 kJ 300 µg/100 kcal 210 µg/100ml
Vitamin B2	19 µg/100 kJ 80 µg/100 kcal 48 µg/100ml	95 µg/100 kJ 400 µg/100 kcal 280 µg/100ml
Niacin	70 µg/100 kJ 300 µg/100 kcal 180 µg/100ml	375 mg/100 kJ 1500 mg/100 kcal 1050 mg/100ml
Vitamin B6	8.5 µg/100 kJ 35 µg/100 kcal 21 µg/100ml	45 µg/100 kJ 175 µg/100 kcal 122.5 µg/100ml

Vitamin B12	0.025 µg/100 kJ	0.36 µg/100 kJ
	0.1 µg/100 kcal	1.5 µg/100 kcal
	0.06 µg/100ml	1.05 µg/100ml
Vitamin K1	1 µg/100 kJ	6.5 µg/100 kJ
	4 µg/100 kcal	27 µg/100 kcal
	2.4 µg/100ml	18.9 µg/100ml
Folic acid	2.5 µg/100 kJ	12 µg/100 kJ
	10 µg/100 kcal	50 µg/100 kcal
	6 µg/100ml	35 µg/100ml
Biotin	0.4 µg/100 kJ	2.5 µg/100 kJ
	1.5 µg/100 kcal	10 µg/100 kcal
	0.9 µg/100ml	7 µg/100ml
Ca-D-Pantothenate	95 µg/100 kJ	475 µg/100 kJ
	400 µg/100 kcal	2000 µg/100 kcal
	240 µg/100ml	1400 µg/100ml

*Calcium:phosphorus ratio shall be between 1 and 2.

**Fluoride shall not be added in infant & follow-on formulae

***1 µg RE = 3.33 IU vitamin A = 1 µg all trans retinol

****In the form of cholecalciferol, of which 1µg = 40 IU of vitamin D.

*****mg α-TE = d-α-tocopherol equivalent

Organoleptic properties:

- Texture: powder without lumps
- Appearance: white of slightly yellowish fine powder, free from impurities/colored particles. The reconstituted milk shall be a homogenous liquid. It shall be white.
- Smell: shall be neutral and typical of milk. It shall not be pungent.
- Taste: shall be characteristic of milk; no rancid, pungent or unpleasant taste.

Contaminants	max
Nitrates	15 mg/kg
Nitrites	0.3 mg/kg
Aluminium	0.6 mg/kg
Melamine	1mg/kg

Microbiology	n	c	m	M	p
Criteria for pathogenic microorganisms					
Salmonella	60	0	0/25g	NA	2
Cronobacter Sakazakii	30	0	0/10g	NA	2
Criteria/indicator for process hygiene					
Mesophilic Aerobic Bacteria	5	2	500/g	5000/g	3
Enterobacteriaceae (EB at 30°C)	10	2	0/10g	NA	2

with n = number of samples units to be taken; c = the maximum allowable number of defective sample units in a 2-class plan or marginally acceptable sample units in a 3-class plan; m = a microbiological limit which, in a 2-class plan, separates good quality from defective quality or, in a 3-class plan, separates good quality from marginally acceptable quality; M = a microbiological limit which, in a 3-class plan, separates marginally acceptable quality from defective quality; p = class plan.

Packaging

Labelling

The following must appear on the primary packaging:

- name of the product
- net weight
- batch number
- date of manufacture
- expiry date
- composition of the product
- nutritional value
- instructions for use
- country of origin
- producer's name and address
- clear statement to the effect that the product is suitable for particular nutritional use for infants from birth when they are not breast fed (labelling shall be designed to provide the necessary information about the appropriate use of the products in order to encourage breast feeding)

The following must appear on the secondary packaging:

- name of the product
- net weight
- gross weight
- batch number
- date of manufacture
- expiry date
- instructions for storage
- country of origin

Instructions for use

Preparation

Instructions for preparation must always be written on the packaging.

A measuring spoon must be supplied in every unit packaging to allow a proper reconstitution of the product. This measuring spoon usually corresponds to the required powder dose for 30 ml water.

0091 RUTF (BP100), cereal biscuit, 510 g (= 9 barres)

BP-100™ is a Ready-to-Use therapeutic food (RUTF) in the form of a compressed biscuit/bar. It is used in the treatment of Severe Acute Malnutrition (SAM) in children and adults. BP-100™ can be consumed as it is or crumbled into boiled drinking water and eaten as a porridge.

Nutritional qualities

BP-100™ is a compressed Ready-to-Use Therapeutic food (RUTF) for treatment of severe acute malnutrition in children and adults. The composition follows the WHO/WFP/UNSSCN/UNICEF joint statement on Community-based Management of Severe Acute Malnutrition. One 57 g bar of BP-100 contains 300 kcal. BP-100™ can be eaten as a biscuit directly from the pack, accompanied by clean drinking water, or crumbled into boiled drinking water and eaten as a porridge. The number of bars required per day depends on the weight of the person, e.g. 2 bars per day for a 3 kg child and approximately 10 bars per day for a 30 kg adult.

Logistical qualities

The shelf life of BP-100™ is 4 years. This enables organizations to make long-term planning and establish preparedness stocks. The optimal logistical properties secure an easy, safe and efficient transportation, distribution, usage and storage under extreme conditions.



0092 EMERGENCY FOOD RATION, carton of 500 g (= 9 bars)

1 bar = 2 tablets of 27.8 g (packed in a greaseproof paper)
(unit for purchase = 9 bars vacuum packed, 500 g)

Main composition

Baked wheat flour, partial hydrogenated soybean oil; sugar, soya protein concentrate, malt extract, minerals, amino acids and vitamins.

All ingredients are of vegetal origin.



0093 READY TO USE SUPPLEMENTARY FOOD, peanut paste, 92 g

The RUSF (= ready to use supplementary food) is a ready to use product used to treat the Moderate Acute Malnutrition (MAM).

RUSF can also be used as a nutritional support in emergency situations or in the context of nutritional programs to prevent malnutrition.

Ready to Use Supplementary Food (RUSF) in paste form, soya- based, cocoa taste.

Sachet of 92 g

Main composition

Vegetable fat (contains essential fatty acids), sugar, peanut paste, whey, maltodextrin, soya flour, cocoa, mineral and vitamin complex, emulsifier: lecithin.

Supplementary Plumpy does not contain any ingredient of animal origin, except whey.

Example: PlumpySup®, eeZeeRUSF



0094 TUBE, FEEDING, CH 10, Luer tip, 50 cm, disposable

General information

For gastro-enteral feeding using Luer-tip syringes.

For ventricular lavage.

Specifications

A thin, flexible and hollow sterile cylinder used to access a patient's stomach through the nose and nasopharynx; used primarily for enteral feeding and administering medication.

Synonym: Nasogastric feeding tube.

Materials:	Polyvinyl chloride (PVC), medical grade.
Description:	- Single channel tube.
	- Radio-opaque line for continuous X-ray.
	- Marked 20cm from the distal end.
	- Round and smooth-ended tip.
	- Two opposite ovals, displaced side holes or eyelet.
	- Connector with a Luer tip and stopper.
	- Length: for size CH06 and CH08 is 40-50cm; for CH10 50-60cm.
Unit presentation:	1 feeding tube, sterile, single-use, peel pack.
Primary packaging:	Must be supplied in a sterile peel or blister pack. Labelling should mention: Manufacturer's name and/or trademark. "sterile", lot number, expiry date by year and month, "for single use", CE mark and reference number for notifying body, product description, and instructions for use. Must be

	multilingual: English, French and Spanish, others when available.
Secondary packaging:	Protected unit, one (1) box with 50- or 100-unit presentation, labelling to is the same as that of primary packaging.
	Additional required information: Number of units per secondary packaging. Information for product-specific storage conditions (e.g., temperature, pressure, light, humidity, etc.).
Other requirements:	Norms: Must comply with:
	- Medical Device Directive 93/42/EEC, risk class IIa
	- EN 1615: Enteral feeding catheters and enteral giving sets for single use and their connectors - Design and testing
	- EN 550 Sterilization of Medical Devices - Validation and Routine Control of Ethylene Oxide Sterilization.



0095 Tube, gastric, CH 16, conical tip, 120cm, sterile

0096 Tube, gastric, CH 12, conical tip, 120cm, sterile

0097 Tube, gastric, CH 08, conical tip, 120cm, sterile

0098 Tube, gastric, CH 06, conical tip, 120cm, sterile

General information

For liquids and/or air drainage and aspiration from the stomach (gastric area).

For feeding adults and older children.

For gastric lavage.

For surgical ileus; application of conservative treatment using gastric decompression.

Specifications

A single hollow cylinder introduced into the gastrointestinal (GI) tract, nasally or orally, for aspiration or feeding.

Materials:	Polyvinyl chloride (PVC)
	Single channel tube with conical or funnel tip.

	Tube: Transparent, with X-ray radio-opaque markings at 40, 50, 60 and 70cm from the distal end, corresponding to the cardia, stomach, duodenum and jejunum.
	- Patient end: soft, rounded closed-ended tip, and 4 lateral opposite the alternative eyelets.
	- Size: Diameter CH06 to CH20, length 120-125cm.
	Connector: funnel or cup tip to fit aspiration system or drainage bag.
Unit presentation:	1 gastric tube, sterile, single-use, peel pack.
Primary packaging:	Peel pack.
	Labelling: Manufacturer's name and/or trademark, "sterile", lot number, expiry date by year and month, "for single use", CE mark plus reference number for notifying body, product description, and instructions for use. Must be multilingual: English, French and Spanish, others when available.
Secondary packaging:	Protected unit, one (1) box with 20- or 50-unit presentation. Labelling is the same as primary packaging.
	Additional required information: Number of units per secondary packaging. Information for product-specific storage conditions (e.g., temperature, pressure, light, humidity, etc.) and user recommendations.
Other requirements:	Norms: Must comply with:
	- Medical Device Directive 93/42/EEC, risk class IIa
	- EN 1615: Enteral feeding catheters and enteral giving sets for single use and their connectors - Design and testing
	- EN 550 gas sterilization ethylene oxide



0099 TAP, 3-WAYS, for infusions, with 10cm extension

General information

A device used with an intravenous (IV) administration set; manually-operated by a nurse or qualified medical personal, it regulates fluid delivery to a patient's vascular system.

Specifications

- Also referred to as a 3-way stopcock with connexion tubing or an intravenous line stopcock.

- Suitable for all types of pressure infusion systems < 4 bar
- Liquid resistant.
- Continuous straight-flow channels for accurate pressure monitoring

Components:

3-way stopcock:	Materials: polycarbonate A rotating device with 3 connections with 3-way valves and a handle that turns 360°.
	- 1 Luer male connection near the patient end.
	- 2 Luer female connections near the IV line.
Tubing:	- Materials PVC
	- Length 10cm with a male Luer lock connection on the patient end.
	- Transparent to enable bubble detection, supple, resistant to kinking.
	The tubing cannot be removed from the 3-way stopcock
Quality requirements:	Complies with European <i>Medical Device Directive</i> Council directive 93/42/EEC or equivalent.
Meet standard:	EN-ISO 20594-1: <i>Conical fittings with a 6% (Luer) taper for syringes, needles and certain other. Medical equipment - Part 1: General requirements (ISO 594-1:1986).</i>
Unit presentation:	1 unit, sterile, individually peel packed, single-use.
Primary packaging:	Labelling: Manufacture's name and/or trademark, product description and reference number, "sterile" and method, lot number, expiry date by year and month, "for single use", CE mark and reference number of notifying body. Must be multilingual: English, French and Spanish, others when available.
Secondary packaging:	Protected unit, one (1) box with 50- or 100-unit presentation, labelling is the same as the primary packaging.
	Additional required information: Number of units per secondary packaging. Information for product-specific storage conditions (e.g., temperature, pressure, light, humidity, etc.).
Transport packaging:	Labelling: same as secondary packaging with product-specific transport and storage instructions and quantity of secondary packaging.
Protective packaging:	Carton, labelling is the same as the unit presentation including indication of total quantity.

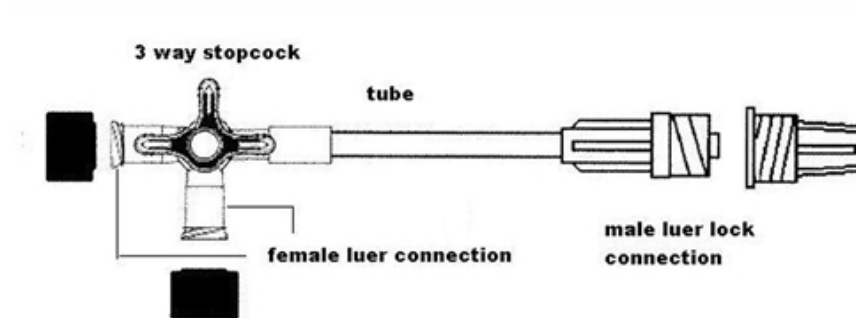

0100 NEEDLE, INTRAOSSEOUS, G14x3cm, sterile, single use

General information

In life-threatening situations, intraosseous needles are used as an alternative for administering drug or fluid infusions to infants and children under 6 years of age.

Specifications

The intraosseous infusion needle is comprised of a blunt, round and open-ended cannula (needle) and a sharp trocar guide. (Dieckmann modification, intraosseous infusion needle)

Needle:	- Cannula
	- Made of stainless steel, plastic hub.
	- Distal tip: blunt, round with two laterally-opposed side ports (eye/hole) positioned near the tip end to ensure flow should the needle tip becomes obstructed by a posterior bone cortex.
	- Positioning mark at 1cm proximal to the tip, used to visualize the depth level.
	- Length 3cm, size G14.
	- Hub at proximal end with circular base plate with plastic fins to anchor it and a Luer-lock connection (not on training needle).
Trocar guide_with gripping handle:	- Material: trocar made of stainless steel and plastic gripping handle.
	- Patient end: sharp, triple bevelled 45° angle.
	- Tubular device located inside the needle.
	- Positioning mark at 1cm proximal to the tip, used to visualize the depth level.

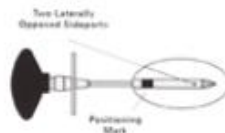

0101 NEEDLE, INTRAOSSEOUS, FOR TRAINING ONLY, G15.5x3cm

General information

In life-threatening situations, intraosseous needles are used as an alternative for administering drug or fluid infusions to infants and children under 6 years of age.

Specifications

The intraosseous infusion needle is comprised of a blunt, round and open-ended cannula (needle) and a sharp trocar guide. (Dieckmann modification, intraosseous infusion needle)

MINSNEEDIOT	Size G15, for training purposes only.
	- Same design but needle and hub are in metal.
	- No positioning mark.
	- No Luer lock connection.

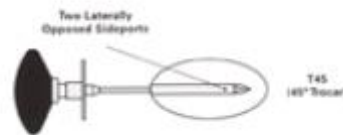

0102 Non-Contact Forehead IR Thermometer, with batteries

General Information:

Instrument used to measure indirect arterial blood pressure; composed of an aneroid pressure gauge connected to an inflatable cuff, which is wrapped around the arm and secured by velcro tape. Synonyms: blood pressure gauge, aneroid sphygmomanometer.

Specifications:

- Validation for temperature range 34°C (or below) to 41°C (or above)
- Accurate to at least 0.5°C with resolution of 0.1°C
- Measurement distance 5 to 15 cm
- Response within 1 sec (or below)
- Battery-operated (AAA)
- Hand-held device



0103 SPHYGMOMANOMETER, adult with 1cuff 14x54,5 cm

General Information:

- Measures body temperature
- Monitors Individuals for temperature change
- Non-contact technique reduces potential spread of diseases

Specifications:

Components:	- Sphygmomanometer parts:
	Aneroid pressure gauge (no stop pin) with an air pressure release-valve.
	Rubber bulb with palm fitting handle.
	Connector to rubber tube.
	Connecting tube.
	Cuff with inflatable bladder.
Materials:	Hardened copper-beryllium: membrane or diaphragm.
	Stainless steel: handle
	Nickel-plated: tube connector and valve.
	Nylon: cuff with velcro fastener
	Latex: connecting tube, bulb, inflatable bag.
Specifications:	A sphygmomanometer consists of an inflatable cuff, a measuring unit (the manometer), a tube to connect the two, and an inflation bulb, which is also connected by a tube to the cuff. The inflation bulb contains a one-way valve, to prevent inadvertent pressure leakage, with an adjustable screw valve with which the operator can lower the pressure in the system in a controlled manner.
	Adult, palm style, sphygmomanometer with one tube.
	Manometer, aneroid gauge:
	- An aneroid manometer is a mechanical gauge with a round dial and a needle that rotates to indicate pressure in mmHg. On the inside, a bellow and spring mechanism senses and transmits the blood pressure measurement to the dial.
	Diameter: 63mm
	Linear scale: graduated from 0-300mmHg, easy-to-read, maximum error throughout range ± 3 mmHg.
	Diaphragm membrane: can withstand overpressures of up to 600mmHg.
	- Connector to rubber tube: on the right-hand side, below the manometer.
	- Inflation bulb: to inflate or deflate the rubber-bag cuff.
	Mounted with a one-way valve, to prevent inadvertent pressure leakage, with an adjustable screw valve with which the operator can lower the pressure in the system in a controlled manner.
	Cuff: Washable at 30°C, made of non-deformable material with velcro fastening to enable a tight adjustment around the arm.
	Inside the cuff is an inflatable airbag (bladder); it must be airtight. Size: 22x10cm.

	XMEQSPHYRIAC14: length 54.5cm, width 14cm
Packaging:	The following information must appear on the outside packaging:
	- Designation of item, multilingual if possible (English, French and Spanish, others when available.)
	- Name and address of supplier (manufacturer) and CE mark and reference number of notifying body.
	- Enclosed inside packaging: manufacturer's certificate of guarantee and multilingual instructions for use and maintenance: Must be multilingual: English, French and Spanish, others when available.
Other requirements:	Conforms to EN 1060-1-1A -2002 and EN 1060-2-1995



0104 Sphygmomanometer, BABYPHON w/ 3 cuffs 5/7/10cm

General Information:

Instrument used to measure indirect arterial blood pressure; comprised of an aneroid pressure gauge connected to an inflatable cuff, which wraps around the arm and is secured by Velcro tape. Synonyms: blood pressure apparatus, aneroid sphygmomanometer.

Specifications:

Components:	Sphygmomanometer parts:
	- Aneroid pressure gauge (with no stop pin), with air pressure release-valve.
	- Rubber bulb with palm fitting handle.
	- Connector to rubber tube.
	- Connecting tube.
	- Cuff with inflatable bladder.
Materials:	Hardened copper-beryllium: membrane or diaphragm
	Stainless steel: handle
	Nickel-plated: tube connector and valve
	Nylon: cuff and velcro
	Latex: connecting tube, bulb, inflatable bag
Specifications:	A sphygmomanometer consists of an inflatable cuff, a measuring unit (the manometer), a tube to connect the two, and an inflation bulb, which is also connected by a tube to the cuff. The inflation bulb contains a one-way valve, to prevent inadvertent pressure leakage, with an adjustable screw valve so that the operator can lower the pressure in the

	system in a controlled manner.
	<i>Manometer</i> , aneroid gauge:
	An aneroid manometer is a mechanical gauge with a round dial and a needle that rotates to indicate pressure in mmHg. On the inside, a bellow and spring mechanism senses and transmits the blood pressure measurement to the dial.
	Diameter: 49mm
	Linear scale: graduated from 0-300mmHg, easy-to-read, maximum error throughout range ± 3 mmHg.
	Diaphragm membrane: can withstand overpressure of up to 600mmHg.
	- Connector to rubber tube: on the right-hand side, below the manometer.
	- <i>Inflation bulb</i> : for inflating and deflating the rubber-bag cuff.
	Mounted with a one-way valve, to prevent inadvertent pressure leakage, with an adjustable screw valve so that the operator can lower the pressure in the system in a controlled manner.
	- <i>Cuff</i> : Washable at 30°C, made of non-deformable material with velcro fastening to enable a tight adjustment around the arm. Inside the cuff is an inflatable airbag (bladder).
	The airbag (bladder) must be airtight.
	3 interchangeable cuff sizes:
	XMEQSPHYRIBC05: Length 15.5cm, width 5cm - newborn
	XMEQSPHYRIBC07: Length 23cm, width 7.2cm - baby or infant
	XMEQSPHYRIBC15: Length 35.5cm, width 10cm - child
	- <i>Connecting tube</i> : length 60cm from cuff to aneroid manometer.
Packaging:	Unit presentation: in a vinyl or leatherette zippered case.
	The following information must appear on the outside packaging:
	- Designation of item, multilingual if possible (English, French and Spanish, others when available.)
	- Name and address of supplier (manufacturer) and CE mark and reference number of notifying body.
	- Enclosed inside the packaging: manufacturer's certificate of guarantee and multilingual instructions for use and maintenance: English, French and Spanish, others when available.
Other requirements:	Conforms to EN 1060-1-1A -2002 and EN 1060-2-1995



0105 BUCKET, plastic, 14L with clip cover and 50mm outlet

General information

Designed by Oxfam to replace the collapsible jerrycan for emergency operations, this family or individual water container offers:

- Water storage, protected from pollution with the clipped cover and cap.
- Easy to fill up and pour with the 50mm opening. Easy to carry by hand with a strong flat handle, on the head with a round bottom shape and a reinforcement ring.
- Efficient cleaning possible by removing the cover and having inner rounded edges.
- Stacking possibilities to lower transport costs (4320 pieces in 1 TC20ft with pallets, 4900 pieces in 1 TC20ft without pallet), 160 pieces per m³.
- Strong and durable quality for a long life span in tough conditions.



0106 EYE WASH BOTTLE, 500ml, reusable, w/o liquid



0107 BASIN/BOWL for washing/footbath, 25L, stackable, min. 40x40x16 cm, preferably rectangular

0108 SOAP, for handwashing, 100g piece

Toilet soap in bar, not harmful to the skin, from vegetable or animal fat, not containing pork fat. Product must be fit for human utilisation and be of sound, fair and marketable quality, of homogeneous colour and aspect, without any disagreeable odours and flavours.	
Fatty acid	minimum 70 %.
Moisture	maximum 20 % at time of packing.
NaOH content	maximum 0.3 %.
NaCl content	maximum 0.5 %.
Weight	bar of 100g each
Packing:	Bars individually packed. 240 bars of 100g per carton.
Box size :	0.35x 0.25x 0.25m. 30 cartons per pallet. Minimum 20MT per 20ft container

0109 Face shield, disposable

Lightweight, single use face shield providing protection against liquid splash and particles and conforming to EC89/686/ECC Category III: EN 166 or equivalent:

- Full face-length from headband down by approx. 30 cm
- Clear screen
- Screen thickness approximately 1 mm
- Adjustable/elastic headband, designed for comfort in tropic climate
- Anti-fog coating
- Fits easily over prescription glasses or protective eyewear



0110 Face shield, reusable

Lightweight, reusable face shield providing protection against liquid splash and particles and conforming to EC89/686/ECC Category III: EN 166 or equivalent:

- Full face-length from headband down by approx. 30 cm
- Clear polycarbonate shield
- Screen thickness min. 1 mm
- Adjustable headband, designed for comfort in tropic climate
- Anti-fog coating
- Fits easily over prescription glasses or protective eyewear
- Resistant to chemicals/highly concentrated chlorine solutions



0111 TUNIC, SURGICAL, reusable, cotton, size L, yellow

Trousers with a string in the waist band, with or without foot cuffs

Material: woven cotton 100%

Weight per m2: minimum 145 g

Colour: yellow

Size XL:

Length: 122 cm

Chest measurement: 115-122 cm

Washing: normal, withstands boiling and autoclaving, resists to chlorine 0.5%



0112 TUNIC, SURGICAL, reusable, cotton, size M, yellow

Trousers with a string in the waist band, with or without foot cuffs

Material: woven cotton 100%

Weight per m2: minimum 145 g

Colour: yellow

Size XL:

Length: 122 cm

Chest measurement: 115-122 cm

Washing: normal, withstands boiling and autoclaving, resists to chlorine 0.5%

Packaging: protected in a plastic bag, single or multiple unit

0113 TUNIC, SURGICAL, reusable, cotton, size S, yellow

Trousers with a string in the waist band, with or without foot cuffs

Material: woven cotton 100%

Weight per m2: minimum 145 g

Colour: yellow

Size XL:

Length: 122 cm

Chest measurement: 115-122 cm

Washing: normal, withstands boiling and autoclaving, resists to chlorine 0.5%

0114 TUNIC, SURGICAL, reusable, cotton, size XL, yellow

Trousers with a string in the waist band, with or without foot cuffs

Material: woven cotton 100%

Weight per m2: minimum 145 g

Colour: yellow

Size XL:

Length: 122 cm

Chest measurement: 115-122 cm
Washing: normal, withstands boiling and autoclaving, resists to chlorine 0.5%

0115 TROUSERS, SURGICAL, reusable, cotton, size L, yellow

Trousers with a string in the waist band, with or without foot cuffs

Material: woven cotton 100%

Weight per m2: minimum 145 g

Colour: yellow

Size XL:

Length: 122 cm

Chest measurement: 115-122 cm

Washing: normal, withstands boiling and autoclaving, resists to chlorine 0.5%

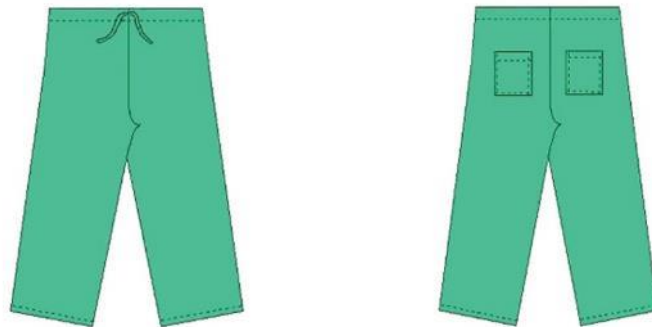

0116 TROUSERS, SURGICAL, reusable, cotton, size M, yellow

Trousers with a string in the waist band, with or without foot cuffs

Material: woven cotton 100%

Weight per m2: minimum 145 g

Colour: yellow

Size XL:

Length: 122 cm

Chest measurement: 115-122 cm

Washing: normal, withstands boiling and autoclaving, resists to chlorine 0.5%

0117 TROUSERS, SURGICAL, reusable, cotton, size S, yellow

Trousers with a string in the waist band, with or without foot cuffs

Material: woven cotton 100%

Weight per m2: minimum 145 g

Colour: yellow

Size XL:

Length: 122 cm

Chest measurement: 115-122 cm

Washing: normal, withstands boiling and autoclaving, resists to chlorine 0.5%

0118 TROUSERS, SURGICAL, reusable, cotton, size XL, yellow

Trousers with a string in the waist band, with or without foot cuffs

Material: woven cotton 100%

Weight per m2: minimum 145 g

REF. DESCRIPTOR
Specification



Colour: yellow

Size XL:

Length: 122 cm

Chest measurement: 115-122 cm

Washing: normal, withstands boiling and autoclaving, resists to chlorine 0.5%

1000 (autoclave combined, 90l) BASKET, stainless steel

Basket for putting load in sterilizer
Material: stainless steel wire mesh
Size: 38 diam cm x 29 (H) cm
With handle
Stackable

To be used with: AUTOCLAVE, COMBINED, 90 l, elec./kero
Two should fit in the chamber
Size optimized for this sterilizer

1001 (centrifuge) TUBE, glass, 15ml, conical bottom, w/o screw cap

Centrifuge tube with conical bottom used to centrifuge urine
Material: transparent glass
Without screw cap
Size: 120 x 17 mm (OD)
Capacity: 15 ml
Non-graduated, rimless
Packaging: protective carton packaging, no of units displayed on carton



1002 (centrifuge) TUBE, polystyrene, 12ml, round bottom, w/o screw cap

Reagent tubes with round bottom
Material: Polystyrene
Size: 100 x 16 mm (OD)
Capacity: 12 ml
Non sterile
Non-graduated, rimless
Packaging: protective carton packaging, no of units displayed on carton



1003 (counting chamber) COVER GLASS, PLANED, 20x26mm, Haemocytometer

The cover glass (Haemocytometer) is used to cover counting chambers (Neubauer & Fuchs- Rosenthal)

Material: glass

Thickness 0.4 mm

Optically flat

Packaging: protective

To be used with: COUNTING CHAMBER, FUCHS-ROSENTHAL, depth 0.2mm, simple grid
COUNTING CHAMBER, NEUBAUER, modified model, depth 0.1 mm



1004 (d.redon) BOTTLE, 500 ml, w/plug, ring and clamp, autocl., reus.

Glass graduated bottle with manometric plug to create a strong depression (vacuum)
Used in surgery for the aspirating drainage of wounds

Components:

- Bottle, glass, screwed, 500 ml capacity
- Plug, manometric, complete
- VALVID Ring for bottle 500 ml, silicone, fitted with a connection piece and two antennas for vacuum control, enables to put the system under vacuum during sterilization by steam autoclave
- Ring for bottle 500 ml: screw system, used to close the bottle
- Spigot for manometric plug: fits on the connection piece of manometric plug, enables to keep the circuit closed and sterile
- Clamp for manometric plug: to clamp the connector of the manometric plug, allows to keep the vacuum before use

The generated vacuum is about 700-800 milibar

The whole is supplied non-sterile and is autoclavable

Packaging:

- Bottle: unit packaging in protective bubble plastic
- Other items: bulk presentation in a plastic sachet

1005 (d.redon) NEEDLE, CH 10, straight, bent tip, autocl., reus.

To insert the drain into the body

Material: stainless steel

19 cm long

Distal end: triangular point for insertion

Threaded proximal end to attach the drain

Non sterile, autoclavable

1006 (dermatome Humby), BLADE

For DERMATOME HUMBY, used in SET, SKIN GRAFT, instruments

1007 (dosimeter pen) CHARGER

Material: all metal parts stainless steel
The charger requires no batteries
By pulling a trigger, a dosimeter is easily placed in or removed from the charger
The clamping action holds the dosimeter
Power: 15,000 volt piezoelectric generator
Clamping mechanism: adjustable and self locking, spring loaded
Temperature Range: operating: -20°C to +50°C
Humidity Range: 0 to 90% Relative Humidity
Weight: approx. 245 g
Size: 152.4 x 107.9 (at its widest point) x 22.2 mm



1008 (filter Katadyn, indoor, drip type) CERAMIC BONDED ELEMENT

Ceramic filter element with activated carbon
To be used with: FILTER KATADYN, for indoor, drip type, incl. 3 filter elements

1009 (haemoglobinometer, Sahli), PIPETTE, GLASS, SAHLI, 20µl

Sahli pipette 20µl is used to measure exactly 20 µl capillary bloods
Material: glass
Length: 125 mm
Tolerance: 0.4 µl
With permanent graduation at 20 µl
Reusable
Packaging: single, protective wrapping in plastic bags
To be used with: HAEMOGLOBINOMETER, SAHLI, set

1010 (haemoglobinometer, Sahli), ROD STIRRING, GLASS, SAHLI

Used to mix the capillary blood with the HCl inside the Sahli Haemoglobin tube

Material: glass

Length: 140 mm

To be used with: HAEMOGLOBINOMETER, SAHLI, set

1011 (haemoglobinometer, Sahli), TUBE, GRADUATED, GLASS, SAHLI

Round measuring tube, scaled 10-140% in 1% steps on one face and 2 to 22g haemoglobin in 0.2 g steps on the opposite face

To be used with: HAEMOGLOBINOMETER, SAHLI, set

1013 TAPE, adhesive, red-white, 50 m, 5 cm width

1014 TAPE, adhesive, yellow, 50 m, 5 cm width

1015 AGGLUTINATION TILE, CERAMIC, with 12 round holes

Ceramic tile allowing to control the blood group by mixing blood and blood group reagent in the holes

Material: ceramic

Tile with 12 holes, re-usable after washing



1016 ALARM CLOCK, digital, 1sec-24h

Timer digital interval with ringer for timing staining techniques, biochemistry tests, ESR tests

Interval 1 sec to 24 hours

With ringer or signal



1017 RESPIRATOR, ANAESTHESIA, portable draw-over system

Portable Draw-over Anaesthesia System which can be used with a separate respirator
Like 'Glostavent® DPA 01'

Weight: 9.5 kg

Accepts any oxygen source available and ventilation is carried out using the in-line self-inflating bag

Suitable for continuous flow or draw-over anaesthesia

Extremely low maintenance, works in difficult conditions

To be supplied with: Draw-over vaporiser (Halothane / Isoflurane or Sevoflurane)

Self-inflating bag

Non re-breathing patient valve and mask

Oxygen supplementation tube

Oxygen conservation and reservoir system

Adult and paediatric circuits

Instruction manual

Case



1019 ANALYSER, DRY CHEMISTRY

Used to perform biochemistry examinations by dry chemistry with different strips from specimen such as whole blood, plasma and serum

Like Roche Reflotron-Analyser

Analyser to determine different biochemistry results by dry chemistry

Measurement temperature: 37°C

Results after 2 -3 min

18 -30 tests per hour

Operable temperature range: 15°C to 34°C

Humidity max.: 95%

Printer integrated

Memory capacity up to 60 results with date, hour and patient identification number

Electricity: 115 - 230 V (\pm 22%)

To be supplied with: 1 Workstation

5 rolls Printing paper

5 pcs Printing colour band

Reflotron@Clean + Chek for 15 tests



1021 ANTI MOULD STRIP

Used for fixing inside the tubular opening and inside the microscope head to protect the back side of the oculars, the tubus lens and the above objective lens

Like Nikon MXA20376

Material: anti mould chemical strip fixed on a plastic device

The anti mould chemical strip contains a toxic substance, which evaporates so that fungus should not grow at the optical lenses

The strip should be replaced every three years

Install the strip immediately after taking it out from the package

Do not eat or swallow; keep away from small children and pets

1022 APPLICATOR STICK, 200 mm, wood, without cotton

Used to mix body fluids with reagent, or prepare slides for microscopy such as sputum smears

Material: wood

Non sterile, disposable



1023 APRON, protection for X-ray, GONADE, 0.5 mm Pb, large

Gonadal protection for X-ray examinations of the thorax and of the upper abdominal region
Flexible, weight optimized lead

Multilayer material made of natural rubber with specially coated ComforTex cover

Hip tension strap for putting on and taking off the apron easily

Lead equivalent: 0.5 mm Pb

Other requirements: corresponds to DIN 6813, RöV, IEC



1024 APRON, reusable, heavy duty, acid resistant, PVC

Worn over work wear when carrying out certain surgical procedures and cleaning work in the sterile services department

Material: PVC or nitric rubber

Straight apron with bib, back fastening and adjustable neck strap

High tear resistance and tear propagation resistance, very flexible and lightweight

Welded-on plastic eyes for neck bands and side bands of polyester.

Standard adult size approx 120 x 90 cm

Thickness: min. 0.3 mm

High resistance to fats, acids and heat

Can be washed and disinfected

Non-sterile, multiple use

Approved as clothing for protection against chemicals based on EN 14605 (type 3 and 4)



1025 APRON, plastic, white, 125 cm long x 75 cm wide, disposable

Used to protect clothing or work wear

Material: white plastic

Packaging and labeling: no. of units on case or bag

Category 1 Personal Protective Equipment according to Annex I of Regulation (EU) 2016/425

1026 APRON, plastic, white, 150 cm long x 75cm wide, disposable

Used to protect clothing or work wear

Material: white plastic

Packaging and labeling: no. of units on case or bag

Category 1 Personal Protective Equipment according to Annex I of Regulation (EU) 2016/425

1027 APRON, X-ray protection, radiologist, 0.35 mm Pb, large

Back panels should guarantee sufficient X-ray protection for shoulder blades and ribs on the back of the body

Rubber tape with snap fasteners at the back

Lead equivalent:

- in the front part: 0.35 or 0.50 mm Pb
- in the back panels: 0.25 mm Pb

Large size: from approx. 115 cm chest

Other requirements: corresponds to DIN 6813, RöV, IEC and CE



1028 APRON, SURGICAL, 90 cm x 140 cm, reusable

Protective apron for surgeons and midwives
Material: rubber
Reusable, autoclavable, boilable
Moisture-proof and stain resistant

1031 AUTOCLAVE, 14 ltr, electric

Steam sterilizer, pressure type, used to sterilize medical devices (non-wrapped instruments, laboratory glassware etc.)

Components:

- Pressure vessel containing a perforated basket with feet
- Cover with rubber seal
- Pressure gauge
- Pressure regulator
- Safety valve

Materials: metal pressure vessel, cover and basket in aluminium alloy or stainless steel, seals of silicone rubber

Metal vessel with high-pressure seal suitable for carrying out sterilization using superheated steam

With capability for creating vacuum after sterilization phase (by condensation) for improved drying

With built in electrical heating

230 V-2 KW

Capacity: 14-15 litre

Internal Height (useable): approx 245 mm

Internal Height (total): approx 280 mm

Internal Diameter: 280 mm

Design Pressure: 1.3 bar (18 psi)

Design Temperature: 0 - 125°C

Maximum Working Temperature: 121°C

Standard Working Temperature: 121°C

Manual timing

Labeling: name and address of supplier (manufacturer), manufacturer's guarantee certificate and accompanying instructions for use to be included inside the package

Other requirements: to comply with H&SE PM73 (Lid Locking Devices) BS3456 Part 101 1987 (Electrical Safety)
CE Marked in compliance with EMC regulations 1992
CE-mark according Low-Voltage-Directive 73/23/EWG

To be supplied with: 1 gasket or sealing ring
1 inner lining with handles

1032 AUTOCLAVE, COMBINED, 90 l, elec./kero., incl. kero. burner

Autoclave for hospitals with surgical activities, in outlying hospital or emergency surgical set up where running water and energy source are scarce

The sterilizer should be suitable for the sterilization of medical supplies:

- Porous loads
- Surgical instrument sets
- Rubber ware

Functional requirements:

The processed load shall meet the requirements given in the European standards EN556 in terms of Sterility Assurance Level. The manufacturer shall provide written confirmation of compliance to these requirements

Compliance to these requirements implies:

- operating temperature: 120-134°C
- the presence of provisions for adequate pre-sterilization air-removal, using above atmospheric steam pulses
- the presence of provisions for adequate drying by a vacuum system using the principle of condensation of steam (through water or air cooled condensor)
- the presence of admission of filtered air into the chamber after the vacuum phase for drying
- successfully passing the full porous load test as per EN285 including the standard Bowie and Dick test pack

Chamber:

- volume in the range of 80-100 litres
- preferably be fitted with a jacket
- stainless steel
- extra port for thermocouple entry

Steam generation:

- Steam shall be generated in the sterilizer chamber, jacket or separate steam generator
- Energy supply should be possible by electricity, kerosine and gas

Control system:

- Valves shall be operated mechanically (not by electric solenoid valves nor pneumatic valves)
- It should be possible that relevant components (valves, locks etc) can be operated manually
- It should be possible to step through the phases of the sterilization process manually
- In order to reduce the chance of operator mistakes, single-knob operation for manual stepping through the sterilizing process preferred
- An indicator shall display the current phase of the process
- Where powered automatic or semi-automatic control systems are incorporated, it should be possible to commence through the process steps manually in case of a breakdown of the automatic control system or the failure of electrical power to the control system
- Temperature control of the sterilization phase of the process can be through temperature or pressure. When controlled by pressure, it should be possible to compensate for the altitude of the location of installation. Adequate instructions shall be provided for calibrating the controller to correct temperature.

Instrumentation:

- Pressure gauge for jacket pressure, when fitted (preferred units in Bar or Pascals)
- Pressure gauge for chamber pressure (preferred units in Bar or Pascals)
- Thermometer indicating chamber temperature at the steam exhaust from the chamber (in °

- C and °F)
 - Timer (either built-in or supplied as a separate item)
 - If necessary the units on gauges can be adjusted to the requirements of the client
 - Mechanical and electrical safety and quality
 - Pressure vessels, piping and the safety devices should comply with relevant international standards (prEN 13445; unfired pressure vessels)
 - Any electrical circuitry should comply with relevant international standards (IEC 61010-2- 045)
 - The electrical heating system shall be 3 phase; 230/400VAC)
 - Any electrical circuitry should allow voltage fluctuations of up to 25% above and below nominal voltage. If electronic components are used, the power supply to the electronic circuitry should incorporate a voltage stabilizer allowing voltage fluctuations of 30% and suppressing peak voltages and reducing the fluctuations to a maximum of 10%
 - The machines shall be designed for an operational lifespan of approx 15 years of normal use
- Kerosene burners shall meet minimum safety and performance requirements

All components shall be non-corrosive or protected such that corrosion will not occur

Safety provisions:

- Means shall be fitted to prevent the opening of the lid or door while the chamber is pressurized
- The sterilizer shall have provisions for the testing of the operation of the pressure safety devices
- Where possible, the design shall reduce the chance of injuries caused by hot components

Accessories:

- Pieces of adequate tubing/piping for steam exhaust, cooling water (if applicable)
- Cable for electrical connection (if applicable)

Spare parts:

The sterilizer shall be provided with a set of spare parts required for a period of 3 years of normal operation

Required spares will depend on the actual design

The following is a guideline:

- Lid/door gaskets
- Heating elements
- Set of bulbs for indicator lights

Quantities of spare parts shall be recommended by the manufacturer, based on the expected lifespan of the specific parts

The manufacturer shall ensure that spare parts are available for a period of at least 10 years after commissioning of the steriliser

The manufacturer shall specify, wherever possible, alternative parts and/or instructions for temporally emergency repairs

Maintenance:

- It shall be possible to perform all standard maintenance work with a basic, standard set of tools for mechanical/electrical engineering

To be used with: (autoclave combined, 90l) BASKET, stainless steel
DRUM, STERILIZING, 18 cm, diam. 17 cm, filter in top and bottom
DRUM, STERILIZING, 18 cm, diam. 34 cm, filter in top and bottom
DRUM, STERILIZING, 28 cm, diam. 34 cm, filter in top and bottom



1033 BAG, 12 x 15 cm, "MINIGRIP" type, plastic

1034 BAG, COLOSTOMY, No 30, adhesive, disposable

For collecting stools from a patient with a colostomy (artificial anus)

Closed adhesive stoma pouch with deodorising filter and pre-cut opening

Adheres directly to the skin

Pouch that is not drainable from the bottom

When it is to be emptied, it is removed and thrown away

Pouch:

- 3 transparent odour film layer with microporous adhesive tape allowing moisture vapour to pass through
- Water proof backing

Deodorising filter:

- small square sachet inside the pouch containing sur activated charcoal granulate fiber which absorbs gases and the unpleasant smells produced by the bowel

Size of pouch: 22.6 x 16.5cm

Opening diameter: 35 or 45mm



1035 BAG, COLOSTOMY, No 45, adhesive, disposable

For collecting stools from a patient with a colostomy (artificial anus)
Closed adhesive stoma pouch with deodorising filter and pre-cut opening
Adheres directly to the skin
Pouch that is not drainable from the bottom
When it is to be emptied, it is removed and thrown away
Pouch:

- 3 transparent odour film layer with microporous adhesive tape allowing moisture vapour to pass through
- Water proof backing

Deodorising filter:

- small square sachet inside the pouch containing sur activated charcoal granulate fiber which absorbs gases and the unpleasant smells produced by the bowel

Size of pouch: 22.6 x 16.5cm

Opening diameter: 35 or 45mm

1036 BAG, PE plastic, for garbage, 30L, black, 0.02mm

Used for domestic garbage
Minimum 0.02mm thick plastic
Material: PE

1037 BAG, PE plastic, for garbage, 60L, black, 0.02mm

Used for domestic garbage
Minimum 0.02mm thick plastic
Material: PE

1038 BAG, plastic for clinical waste, yellow

Safe disposal of clinical waste, for incineration only
Capacity: 60L
Other requirements: according to UN3291

1039 BAG, URINE, 2 l, with tap and non-return valve, graded

Bag which can be emptied in order to avoid unnecessary handlings reduces infection risk and is more economical

Container: plastic, flexible, graduated in 100 ml, with holes for suspending the bag
Inlet tube: 90cm approx. with universal crenellated connector to fit a catheter, with a protective cap

Outlet tube: with drain tap protected by a cap

Material:

- Polyvinyl chloride (PVC) or polypropylene or ethylene vinylacetate (EVA) for the collectors
- Medical grade Polyvinyl chloride (PVC) for the tubes

Non - return valve inside the reservoir: upper part / urine entry

Emptying tap with sealing cap to maintain sterility inside the reservoir

Non-sterile, disposable

Other requirements: meets norm EN ISO 8669-2



1040 BANDAGE, ELASTIC, 8 cm x 5 m, constraining

Light support bandage also known as short stretch or minimal stretched bandage
These bandages are designed to "lockout" at a low level of extension avoiding high level of pressure

Thus can be used to give support to sprained or strained joint and to prevent swelling without applying high level of compression to underlying tissue

Material: Fabric, plain weave, warp/polyamide 36 % filament, weft/ cotton or viscose 63%
Alternative: cotton fabric, plain weave, treated to impart some elasticity: warp twisted cotton threads weft of cotton

Fast edges, one continuous length

Low extensible - short -stretch bandage, with durable elasticity

Colour: white

Extensibility approx. 90% +/- 10

Length stretched/ nominal length: 5m/64 g/m

Length un-stretched: 2.63m/ 120 g/m

Elasticity: maintained after washing, stretching and autoclaving at 135°C

Non-detectable by X-ray, non-sterile

Packaging: Protective wrapping and bulk carton with length and width displayed on the label



1041 BANDAGE, ELASTIC, 10 cm x 5 m, constraining

Light support bandage also known as short stretch or minimal stretched bandage
These bandages are designed to "lockout" at a low level of extension avoiding high level of pressure

Thus can be used to give support to sprained or strained joint and to prevent swelling without applying high level of compression to underlying tissue

Material: Fabric, plain weave, warp/polyamide 36 % filament, weft/ cotton or viscose 63%
Alternative: cotton fabric, plain weave, treated to impart some elasticity: warp twisted cotton threads weft of cotton

Fast edges, one continuous length
Low extensible - short -stretch bandage, with durable elasticity
Colour: white
Extensibility approx. 90% +/- 10
Length stretched/ nominal length: 5m/64 g/m
Length un-stretched: 2.63m/ 120 g/m
Elasticity: maintained after washing, stretching and autoclaving at 135°C
Non-detectable by X-ray, non-sterile
Packaging: Protective wrapping and bulk carton with length and width displayed on the label

1042 BANDAGE, ELASTIC, 12 cm x 5 m, constraining/compressive

Elastic bandage is designed to produce contention / compression to improve oedema re-absorption and to prevent post-operative thrombosis
High extensible, medium stretch compression bandages, with durable elasticity, have a high recoiling force and are thought to increase expelled blood volume and reduce venous hypertension
They apply a sustained level of compression over time
Material:
- Woven fabric 83% cotton; 14% polyamide, 3% polyurethane
- The weft threads of the bandage are made of cotton and the warp threads of false-twisted polyamide and polyurethane that together impart a high degree of elasticity
Colour: skin
Extensibility approx. 187 % +/- 10
Length stretched: 5 m/136 g/m²
Length un-stretched: 1.74 m/390 g/m²
Nominal Width: 15cm
Elasticity: maintained after washing, stretching and autoclaving
Non-detectable by X-ray, non-sterile
Acceptable alternative:
Material: high-twist cotton threads with normal-twist cotton threads in warp 100% cotton ("crepe bandage" with blue lines)
Colour: skin
Warp: 12 threads/cm, unbleached cotton, high-twist
Weft: 5 threads/cm ± 2 threads unbleached cotton
Length un-stretched: 2.5 m to 3 m
Length stretched: 5 m with 150% elasticity minimum
Packaging: protective wrapping and bulk carton with length width and material displayed on the label



1043 BANDAGE, ELASTIC, 15 cm x 5 m, constraining

Light support bandage also known as short stretch or minimal stretched bandage
These bandages are designed to "lockout" at a low level of extension avoiding high level of pressure
Thus can be used to give support to sprained or strained joint and to prevent swelling without applying high level of compression to underlying tissue
Material: Fabric, plain weave, warp/polyamide 36 % filament, weft/ cotton or viscose 63%
Alternative: cotton fabric, plain weave, treated to impart some elasticity: warp twisted cotton threads weft of cotton
Fast edges, one continuous length
Low extensible - short -stretch bandage, with durable elasticity
Colour: white
Extensibility approx. 90% +/- 10
Length stretched/ nominal length: 5m/64 g/m
Length un-stretched: 2.63m/ 120 g/m
Elasticity: maintained after washing, stretching and autoclaving at 135°C
Non-detectable by X-ray, non-sterile
Packaging: Protective wrapping and bulk carton with length and width displayed on the label

1044 BANDAGE, ESMARCH, 8 cm x 500 cm

Wide rubber band, used to empty venous blood from an upper or lower limb by applying circular compression from the bottom towards the top
Acting as a tourniquet (e.g. performing endo-venous anaesthesia during hemorrhagic surgery on limbs) in order to limit bleeding
Material: natural rubber
Dimensions: 8cm wide, 5m long, 2mm thick
Autoclavable
Firm, moderate elasticity
Non-sterile



1045 BANDAGE, GAUZE, 6 cm x 4 m, elastic, non sterile

Material: bleached purified textile, plain weave gauze, absorbent, 100% cotton
Selvedge protects against fraying
Thread Count:
- Warp: 12 threads/cm
- Weft: 8 threads/cm
Weight: Approx. 27.5 g/m²
Non-elastic, non-adhesive and non-detectable by X-ray, non-sterile
Packaging: in rolls, individually presented in suitable protective wrapping with the following

information on the labels:

- Length
- Width
- Material
- Type of bandage

Other requirements: meets Pharmacopoeia specifications



1046 BANDAGE, GAUZE, 08 cm x 4 m, elastic, non sterile

Material: bleached purified textile, plain weave gauze, absorbent, 100% cotton

Selvedge protects against fraying

Thread Count:

- Warp: 12 threads/cm
- Weft: 8 threads/cm

Weight: Approx. 27.5 g/m²

Non-elastic, non-adhesive and non-detectable by X-ray, non-sterile

Packaging: in rolls, individually presented in suitable protective wrapping with the following information on the labels:

- Length
- Width
- Material
- Type of bandage

Other requirements: meets Pharmacopoeia specifications

1047 BANDAGE, GAUZE, 10 cm x 4 m, elastic, non sterile

Material: bleached purified textile, plain weave gauze, absorbent, 100% cotton

Selvedge protects against fraying

Thread Count:

- Warp: 12 threads/cm
- Weft: 8 threads/cm

Weight: Approx. 27.5 g/m²

Non-elastic, non-adhesive and non-detectable by X-ray, non-sterile

Packaging: in rolls, individually presented in suitable protective wrapping with the following information on the labels:

- Length
- Width
- Material
- Type of bandage

Other requirements: meets Pharmacopoeia specifications

1048 BANDAGE, GAUZE, 12 cm x 4 m, elastic, non sterile

Material: bleached purified textile, plain weave gauze, absorbent, 100% cotton
Selvage protects against fraying

Thread Count:

- Warp: 12 threads/cm
- Weft: 8 threads/cm

Weight: Approx. 27.5 g/m²

Non-elastic, non-adhesive and non-detectable by X-ray, non-sterile

Packaging: in rolls, individually presented in suitable protective wrapping with the following information on the labels:

- Length
- Width
- Material
- Type of bandage

Other requirements: meets Pharmacopoeia specifications

1049 BANDAGE, JERSEY, TUBULAR, cotton, unbleached, 2,5cmx25m

Material: 100% cotton, unbleached, non-sterile
Elasticity: minimum of 3-4 times the original width
Knitted jersey tube without seam

Good resistance to laddering in both directions

Packaging: in rolls individually presented in suitable protective wrapping with the following information on the labels:

- Length
- Width
- Material

Other requirements: meets Pharmacopoeia specifications

1050 BANDAGE, JERSEY, TUBULAR, cotton, unbleached, 6cmx25m

Material: 100% cotton, unbleached, non-sterile
Elasticity: minimum of 3-4 times the original width
Knitted jersey tube without seam

Good resistance to laddering in both directions

Packaging: in rolls individually presented in suitable protective wrapping with the following information on the labels:

- Length
- Width
- Material

Other requirements: meets Pharmacopoeia specifications

1051 BANDAGE, JERSEY, TUBULAR, cotton, unbleached, 10cmx25m

Material: 100% cotton, unbleached, non-sterile
Elasticity: minimum of 3-4 times the original width
Knitted jersey tube without seam

Good resistance to laddering in both directions

Packaging: in rolls individually presented in suitable protective wrapping with the following information on the labels:

- Length
- Width

- Material
- Other requirements:** meets Pharmacopoeia specifications

1052 BANDAGE, JERSEY, TUBULAR, cotton, unbleached, 15cmx25m

Material: 100% cotton, unbleached, non-sterile
Elasticity: minimum of 3-4 times the original width
Knitted jersey tube without seam
Good resistance to laddering in both directions
Packaging: in rolls individually presented in suitable protective wrapping with the following information on the labels:

- Length
- Width
- Material

Other requirements: meets Pharmacopoeia specifications

1053 BANDAGE, PADDING, FOR PoP, 10 cm x 2,7 m

Material: 100% Viscose fiber, non-woven undercast padding material
Viscose makes the product highly absorbent, reducing the risk of skin maceration

1054 BANDAGE, PADDING, FOR PoP, 15 cm x 2,7 m

Material: 100% Viscose fiber, non-woven undercast padding material
Viscose makes the product highly absorbent, reducing the risk of skin maceration

1055 BANDAGE, PLASTER OF PARIS, 10 cm x 3 m

A gauze bandage coated with Plaster of Paris
The bandage is supplied wrapped around a plastic spools which is designed to allow rapid and even wetting upon immersion
Once wet the bandage sets to form a hard rigid structure, which is both porous and absorbent

Material:

- Textile base: Plain weave gauze fabric, 17 threads
- Plaster of Paris: Blend of alpha & beta forms of calcium sulphate hemi hydrate, together with binders and accelerators to made the POP stick on the textile base
- Spool: plastic

Soaking temperature: 20-25°C (check manufacturer instructions)

Immersion time: 7- 8 seconds (check manufacturer instructions)

Rapid setting: 100 seconds

Permeable to X-ray

Packaging:

One roll presented in a heat-welded protective wrapping (against humidity) with the following information on the wrapping label:

Length, width, rapid setting, lot no, exp date, manufacturer

Direction of use: on labeling or separate

Storage recommendations:

- Keep under dry conditions (deteriorates under exposure to dampness)
- Keep at moderate temperature max. 25°C (deteriorates under exposure to heat)

Other requirements: meets Pharmacopoeia specifications

To be used with: BANDAGE, JERSEY, TUBULAR, cotton, unbleached, 4 cmx25m (or

06 cm, 08 cm wide)
BANDAGE, PADDING, FOR PoP, 10 cm x 2,7 m

1056 BANDAGE, PLASTER OF PARIS, 15 cm x 3 m

A gauze bandage coated with Plaster of Paris

The bandage is supplied wrapped around a plastic spools which is designed to allow rapid and even wetting upon immersion

Once wet the bandage sets to form a hard rigid structure, which is both porous and absorbent

Material:

- Textile base: Plain weave gauze fabric, 17 threads
- Plaster of Paris: Blend of alpha & beta forms of calcium sulphate hemi hydrate, together with binders and accelerators to make the POP stick on the textile base
- Spool: plastic

Soaking temperature: 20-25°C (check manufacturer instructions)

Immersion time: 7- 8 seconds (check manufacturer instructions)

Rapid setting: 100 seconds

Permeable to X-ray

Packaging:

One roll presented in a heat-welded protective wrapping (against humidity) with the following information on the wrapping label:

Length, width, rapid setting, lot no, exp date, manufacturer

Direction of use: on labeling or separate

Storage recommendations:

- Keep under dry conditions (deteriorates under exposure to dampness)
- Keep at moderate temperature max. 25°C (deteriorates under exposure to heat)

Other requirements: meets Pharmacopoeia specifications

To be used with: BANDAGE, JERSEY, TUBULAR, cotton, unbleached, 4 cmx25m (or 06 cm, 08 cm wide)
BANDAGE, PADDING, FOR PoP, 15 cm x 2,7 m

1057 TAPE, BARRIER, striped (red-white), non-adhesive, 80mm x 500 m, roll



1058 BATHING TUB, babies

Thick plastic that won't buckle from baby's weight or the weight of the water

For infants up to approx 2-3 years old

Approx 25 litres

No rough edges



1060 BATTERY CHARGER, 230V, 12 V/25 A, fully automatic

For lead batteries
Input 170 to 275V/50 Hz
Output 12 V / 20A
Automatic I-U-U charging curve
Overload protection
Fused

1061 BATTERY CHARGER, for rechargeable dry cell batteries

For rechargeable dry cell batteries 1.2 V and 9 V, size AA, C, D
For 4 batteries
Power supply: 110-230 V



1062 BATTERY, 3v, coin cell, model 2032, diam.20 mm

1064 BATTERY, dry cell, rechargeable, 1.2V, AA(LR6) 14.5 x 50.5mm

NiMH (nickel metal hydride)

1065 BEAKER, GLASS, 250 ml

Graduated container to measure liquids
Beaker high design, graduated
Packaging: protective bubble foil

1066 BEAKER, GLASS, 600 ml

Graduated container to measure liquids
Beaker high design, graduated
Packaging: protective bubble foil

1067 BEAKER, GLASS, 1000 ml

Graduated container to measure liquids
Beaker high design, graduated
Packaging: protective bubble foil

1068 BEAKER, POLYPROPYLENE OR PMP, 1000 ml

Graduated container to measure liquids
Material: Polypropylene or PMP (TPX)
Beaker low form, graduated

1069 BEDPAN, with handle + cover, plastic, autoclavable

Bedpan for adults confined in bed
Slipper type, with lid and handle
Size: L/W/H: 450 x 280 x 10 mm
Volume: 2,5 litres
Autoclavable at 130°, 20 min maximum
Material: Polypropylene

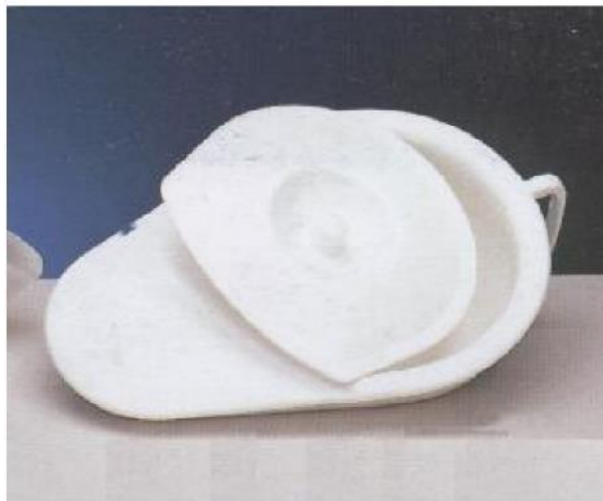

1070 BEDSHEET, white, 1.5m x 2.5m

Single layer
Cotton 150 g/m²
Washable at 90°C

1072 BLADE, SCALPEL, No 10, for handle No 3, sterile

Surgical blade for use with standard handle n°4 and n°3
Material: Martensitic steel (quenched, magnetic steel)
Sterile instrument/disposable
Length: 5.8 cm
Packaging: each blade individually wrapped in laminated foil, box of 100 units
Labeling:

- Exp date, lot number, items description, size, type of sterilization, manufacturer name, ref number, CE + Nr



1073 BLADE, SCALPEL, No 11, for handle No 3, sterile

Surgical blade for use with standard handle n°3
Material: Martensitic steel (quenched, magnetic steel)
Sterile instrument/disposable

Length: 5.8 cm

Packaging: each blade individually wrapped in laminated foil, box of 100 units

Labeling:

- Exp date, lot number, items description, size, type of sterilization, manufacturer name, ref number, CE + Nr



1075 BLADE, SCALPEL, No 20, for handle No 4, sterile

Surgical blade for use with standard handle n°4
Material: Martensitic steel (quenched, magnetic steel)
Sterile instrument/disposable

Length: 5.8 cm

Packaging: each blade individually wrapped in laminated foil, box of 100 units

Labeling:

- Exp date, lot number, items description, size, type of sterilization, manufacturer name, ref number, CE + Nr



1076 BLANKET, medium-thermal, grey, 100% synth., 1.5x2m

washable at 60° C
Medium thermal type (min. Rct=0.25)
Weight: min. 200g/m²; max. 400g/m²
Fire resistance according to ISO12952-1 (resistance to cigarette and flames: no ignition)
Tensile strength according to ISO13934-1

No bad smell, not irritating to the skin
Free from harmful VOC (Volatile Organic Components)

Finish: Whipped seam at 10mm from the edge with 10 to 13 stitches/10cm or stitched ribbon or hemmed on 4 sides; corners can be round up to 10cm radius, or square.



1077 BLENDER, handheld, electrical, 200 W

European plug
To be supplied with: plastic measuring jug, min. 500 ml capacity



1078 BLOOD BAG, CPD Adenine, 450 ml, simple

For collecting blood from the donor, storage and transfusion (using a blood giving set)
With blood sample plug
Material: Di-ethylhexyl phthalate (DEHP) plasticized PVC
Volume of CPDA per bag: 63 ml / 450 ml
Blank label for essential data
Sterile
Packaging:Om
- Sterile sets in aluminium foil

- Airtight wrapping
- Protection against light

Labeling:

- Type and quantity of anti-coagulant
- Capacity of bag
- Expiry date and batch number

To be used with: BLOOD GIVING SET (transfusion)

Other requirements: Conforms to ISO 3826



1079 BLOOD GIVING SET (transfusion)

For transfusion of blood and blood products

Components and materials:

- Tube: PVC based material
- Perforator: stainless steel, encased in polyamide or moulded from ABS or POM (polyacetal)
- Air inlet; Drop-counting chamber: PVC
- Blood filter: polyamide (fibres of PA)
- Flow regulator: polystyrene
- Injection port: latex

The materials must be perfectly compatible with the complex environment of blood

Tube:

- Transparent (allowing the detection of air bubbles), supple, resistant to kinking
- $\pm 150\text{cm}$ long (giving the set an overall length of 170cm)
- Ended by a male, Luer, lock or slip connector, with or without bung, allowing connection to another intravenous systems

The perforator:

- Hollow device situated at the proximal end of the set, allowing the set to be connected to the bottle or flexible blood bag
- Composed of a needle or a tapering tube, mounted on a base ensuring a good seal between the set and the blood container

The air inlet:

- Essential for infusing blood contained in glass or rigid plastic bottles
- bacteriological filter which holds back the micro organisms
- EITHER separated from the perforator (made up of a needle attached to a filtering waterproof membrane or a cotton tube)
- N.B.: Its tip should be situated above the opening of the perforator in order to prevent air bubbles entering the flow canal of the perforator
- OR incorporated into the perforator (made up of a tapering tube attached to a waterproof membrane)

The drop-counting chamber:

- Transparent, supple, compressible bag, with a calibrated tube at its upper end
- Is both a trap for air bubbles and a measuring device of the transfusion flow rate by counting the drops

The blood filter:

- Incorporated into the drop-counting chamber
- Total useful surface area not less than 25 cm²
- May be made of polyamide 6-6 with a mesh of 200 μ ± 20 μ, or similar material of which the effective filtration rate is higher than 80% of the reference polyamide filters effective filtration rate

The flow regulator:

- Situated on the tube between the drop-counting chamber and the connector
- Narrows the lumen of the tubing by compression without damaging the tube
- Allows precise regulation as well as complete cessation of the flow in closed position

The injection port:

- Allows introduction via a needle of an injectable drug into the flow of transfusion
- Formed by a self sealing bung, situated as near as possible to the connector

Sterile, disposable

Packaging:

- 1 infusion set packed in an individual sterilised peel-pack made of paper and/or plastic

Labeling:

- Exp date, lot number, items description, size, type of sterilization, manufacturer name, ref number, CE + Nr



1080 BLOOD SAMPLING, MULTI-ADAPTOR Luer, for multiple sampling

Like 'Sarstedt Item No.14.1205'

Material: Plastic

Safe blood collection system; single use

Packaging and labeling: each adaptor in sterile peel pack, should mention exp date, lot number, items description, size, type of sterilization, manufacturer name, ref number, CE + Nr, protective carton packing with same information and no. of units



1083 BODY BAG, white, u-shaped zip, 4+ grips

Material: PVC
Length: 220 cm minimum
Width: 105 cm minimum
Thickness: 200 micron minimum
Water-proof
Tear-proof
Impermeable seams (double thickness)
Cloth support of the zip is biodegradable after one month underground



1084 BOLSTER FOR KRAMER SPLINT, roll, 5 m

For soft and quick padding of Kramer splint
Material: might vary e.g. 85 % cotton, 15% elastane, unbleached
High water vapor and air permeability
The padding properties remain unimpaired over the whole period of wear
To be used with: SPLINT, KRAMER, 10 cm x 100 cm
SPLINT, KRAMER, 15 cm x 100 cm

1085 BOOTS, rubber (Wellington), size 38, pair

according to EN 345 S5
Sole: material PVC/Nitril, antistatic oil-, acid-, petrol-resistant steel layer in sole
Weight: approx 2 kg/pair
Shaft: material PVC/Nitril
Height: approx 38 cm



1086 BOOTS, rubber (Wellington), size 42, pair

according to EN 345 S5
Sole: material PVC/Nitril, antistatic oil-, acid-, petrol-resistant steel layer in sole
Weight: approx 2 kg/pair
Shaft: material PVC/Nitril
Height: approx 38 cm

1087 BOOTS, rubber (Wellington), size 45, pair

according to EN 345 S5
Sole: material PVC/Nitril, antistatic oil-, acid-, petrol-resistant steel layer in sole
Weight: approx 2 kg/pair
Shaft: material PVC/Nitril
Height approx 38 cm

1088 BOTTLE POLYETHYLENE, 500 ml with screw cap

Polyethylene bottles with screw cap used to distribute and store reagents

1089 BOTTLE POLYETHYLENE, 1000 ml with screw cap

Polyethylene bottles with screw cap used to distribute and store reagents

1090 BOTTLE, FEEDING, plastic, including nipples

Material: unbreakable plastic, food-safe
Bottle size approx. 200 ml (graduated outside in ml)
Heat resistant to boiling water
Reusable, non sterile
Nipples made of silicone
To be supplied with: 10 spare nipples for each bottle

1091 BOTTLE, HOT WATER, rubber, 2 ltr

Ribbed design on one side (for spreading heat more evenly and comfortably)
Light cross-hatched design on reverse side (for more intense heat)



1092 BOTTLE, swan neck jet, plastic, 250 ml

Round bottle with swan neck jet used for staining and rinsing
Material: Polyethylene
Swan neck jet
Dropper nozzle with screw cap



1093 BOTTLE, swan neck jet, plastic, 500 ml

Round bottle with swan neck jet used for staining and rinsing
Material: Polyethylene
Swan neck jet
Dropper nozzle with screw cap

1095 BOWL, SPLASH, 8 l, (330x130 mm), stainless.steel, autocl.

1096 BOWL, WASH, PLASTIC, 14 ltr

Rectangular shape
Size: approx. 40 x 40 x 15 cm



1097 BOWL, WASH, PLASTIC, 2 ltr

Round shape
Diameter: approx. 30 cm



1099 BOWL-STAND, 2 bowls 5l, H 86 cm, 5 antista.castors, st.steel

Double waste bowl stand to be used in operating theatre or in delivery room

Height: approx 860 mm, stainless steel 18/10

Base with 5 legs

Square tubes: approx 20 x 25 mm, stainless steel 18/10

Wheels/castors: diameter 50 mm (minimum), antistatic

Bowls: approx diameter 275 x 125 mm; approx 5 litres, stainless steel 18/10, autoclavable

Knock down construction

Other requirements: must be resistant to corrosion (suitable for tropical environment) and decontamination (chlorine solution)



1100 BOX, INSTRUMENTS, covered, 30x20x5 cm stainless steel

To be used with: SPECULUM, CUSCO, set

1101 BREAST PUMP, manual

Manual pump

2 reusable bottles 125 ml each

2 lids

Nipple and sealing disc

Can be cleaned and disinfected in boiling water



1103 BROOM, with broom stick

The bristles can be of diverse origin, natural or synthetic
They must be stiff and durable, and the tufts must resist strong pulling by hand
Stick made of wood



1104 BRUSH, FOR CLEANING INSTRUMENTS WITH LUMEN, 3mmØ x 30cm

For cleaning of laparoscopic instruments, suction devices etc
White medical grade nylon bristles with surgical stainless steel twisted and spun wire
Resists temperatures up to 100°C
Can be cleaned with soap and disinfected in hot water

1105 BRUSH, FOR CLEANING INSTRUMENTS WITH LUMEN, 5mmØ x 30cm

For cleaning of laparoscopic instruments, suction devices etc
White medical grade nylon bristles with surgical stainless steel twisted and spun wire
Resists temperatures up to 100°C
Can be cleaned with soap and disinfected in hot water

1106 BRUSH, FOR CLEANING INSTRUMENTS WITH LUMEN, 10mmØ x 40cm

For cleaning of laparoscopic instruments, suction devices etc
White medical grade nylon bristles with surgical stainless steel twisted and spun wire
Resists temperatures up to 100°C
Can be cleaned with soap and disinfected in hot water

1107 BRUSH, FOR CLEANING INSTRUMENTS, nylon bristles

Plastic handle
18 cm length with stiff, white medical grade nylon bristles
Resists temperatures up to 100°C
Can be cleaned with soap and disinfected in hot water

1108 BRUSH, FOR CLEANING INSTRUMENTS, soft stainless steel bristles

For use on rasps, files, reamers, burs, blades, drill bits, needle holder jaws, vascular serrations and removing stubborn baked-on stains in the box lock area
Plastic handle
18 cm length with super fine stainless steel bristles
Resist temperatures up to 100°C
Can be cleaned with soap and disinfected in hot water

1109 BRUSH, SCRUB, nylon bristles, autoclavable

For hand scrubbing during pre-surgical hand washing
Must be autoclavable to allow decontamination and sterilization
Material:
- Body: polypropylene (should not be in wood)
- Bristles: nylon
Body length: approx. 8 to 10 cm, width: approx.3 to 5 cm
Soft bristles, 5 rows minimum, height: 1 cm
Non-sterile

1110 BRUSH, SCRUBBING, with broomstick

Brush with strong plastic straw and broomstick designed for domestic purpose
The bristles can be of diverse origin, natural or synthetic
They must be stiff and durable, and the tufts must resist strong pulling by hand.
Stick made of wood

1111 BUCKET, 23 to 26 liters, with lid

To be used for x-ray developing solution and fixerubberr solution
Minimum capacity 23 liters!

1112 BUCKET, KICKABOUT, with lid and handle, foldable stand on castors

Material: base frame and bucket: stainless steel

Bucket:

- Approx 10 ltrs
- with handle and lid
- Can be removed from base frame

Base frame:

- non-tip, solid balanced
- 4 or 5 casters min Ø 50 mm
- With handle for moving

Rubber cushions inside the frame to prevent pail from rattling



1113 BUCKET, plastic, without lid, 10 L

Round bucket

Heavy-duty plastic

Carrying capacity 20 kg

With metal handle

Stacking possibilities to lower transport costs

Strong and durable quality for a long life span in tough conditions



1114 BUCKET, plastic, without lid, 5L

Round bucket

Heavy-duty plastic

Carrying capacity 5 kg

With metal handle

Stacking possibilities to lower transport costs

Strong and durable quality for a long life span in tough conditions

1115 CANNULA, NASAL, OXYGEN, adult, 2 prongs, straight, + tube

To deliver medical oxygen directly to the patient nose via nasal cannulae (nasal prong)

Material: PVC

Oxygen flow rate of 2-4 liters/mn, delivers an FiO₂ of 0.28-0.36 respectively

Prongs:

- Two straight nasal prongs, each protruding about 1 cm in the nose
- Prongs are connected to a lip support and harness (one tube right / left)

Harness:

- fully adjustable with lip support + 2 tubes

Oxygen supply tube:

- length 1.8-2.1 m
- has a coned connector, avoiding the need for extension lines

Other requirements: Conforms ISO 9001 EN 46001 BS 5750

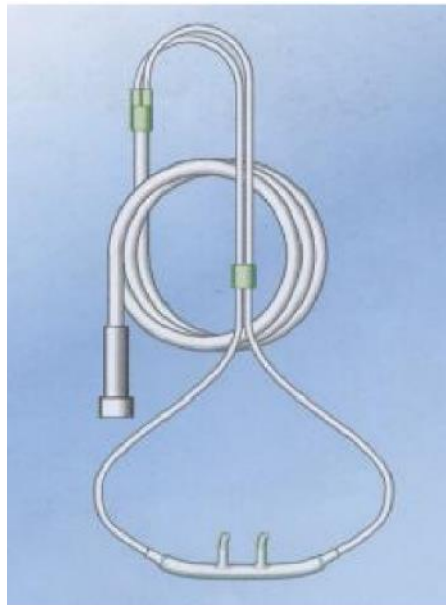

1116 CAP, closing, Luer-Lock-System

Used for closing syringes



1117 SCRUB CAP, non-woven, standard size, blue, disposable

Type: Bouffant

Colour: Blue

Adult model, standard size, rubber banded

Material: Non-woven, disposable

Packaging: carton



1118 CARDIOTOCOGRAPH, baby

Ultrasound transducer
Contractions transducer (TOCO)
Automatic fetal movement detection and motion detection alarms
LED and audio FHR indicator
Clinical event marker and annotation feature
Communication ports
High resolution thermal printer



To be supplied with:
- 10 rolls of CTG paper

1119 CASSETTE, X-RAY, 24 x 30 cm, blue sensitive

A light tight flat container used to hold an X-ray film in close contact with an intensifying screen
Basic screen film system: Blue
Round edges, long lasting, shockproof, light proof
Easy to load and unload: opening recommended minimum 180°
With countersunk relief dot: clearly indicate whether the cassette is loaded with film or not
Material: metallic or tough light plastic (Novadur)
Intensifying screens: rare earth
The sheet is coated with a layer of finely divided crystals calcium tungstate (blue system) which converts x-ray energy into visible light
Packaging: 1 cassette completely marked on the back with speed of the screen and type of film to be used
Other requirements: conform to EN 6832/ANSI PH1.49/EN 60406



1120 CASSETTE, X-RAY, 24 x 30 cm, blue sensitive, with parallel grid

A light tight flat container used to hold an X-ray film in close contact with an intensifying screen

Basic screen film system: Blue

Round edges, long lasting, shockproof, light proof

Easy to load and unload: opening recommended minimum 180°

With countersunk relief dot: clearly indicate whether the cassette is loaded with film or not

Material: metallic or tough light plastic (Novadur)

Intensifying screens: rare earth

The sheet is coated with a layer of finely divided crystals calcium tungstate (blue system) which converts x-ray energy into visible light

Grid: 44 lines/cm

Ratio 10:1

Focus 140 cm

Packaging: 1 cassette completely marked on the back with speed of the screen and type of film to be used

Other requirements: conform to EN 6832/ANSI PH1.49/EN 60406

1121 CASSETTE, X-RAY, 30 x 40 cm, blue sensitive

A light tight flat container used to hold an X-ray film in close contact with an intensifying screen

Basic screen film system: Blue

Round edges, long lasting, shockproof, light proof

Easy to load and unload: opening recommended minimum 180°

With countersunk relief dot: clearly indicate whether the cassette is loaded with film or not

Material: metallic or tough light plastic (Novadur)

Intensifying screens: rare earth

The sheet is coated with a layer of finely divided crystals calcium tungstate (blue system) which converts x-ray energy into visible light

Packaging: 1 cassette completely marked on the back with speed of the screen and type of film to be used

Other requirements: conform to EN 6832/ANSI PH1.49/EN 60406

1122 CASSETTE, X-RAY, 35 x 43 cm, blue sensitive

A light tight flat container used to hold an X-ray film in close contact with an intensifying screen

Basic screen film system: Blue
Round edges, long lasting, shockproof, light proof
Easy to load and unload: opening recommended minimum 180°
With countersunk relief dot: clearly indicate whether the cassette is loaded with film or not
Material: metallic or tough light plastic (Novadur)
Intensifying screens: rare earth
The sheet is coated with a layer of finely divided crystals calcium tungstate (blue system) which converts x-ray energy into visible light
Packaging: 1 cassette completely marked on the back with speed of the screen and type of film to be used
Other requirements: conform to EN 6832/ANSI PH1.49/EN 60406

1123 CATHETER, URINARY, CH 10, 20cm, sterile, disp.

For women
Single use
Transparent
Disposable

1124 CATHETER, URINARY, FOLEY, w/ balloon, CH 08, sterile, disp.

Tube designed to be inserted into the bladder cavity, via the urethra, in order to drain off urine, instill a liquid or irrigate the bladder
The catheter consists of a straight tube with:
- 1 central channel for urinary drainage, with 2 side holes opposite each other and a rounded tip at distal end and a truncated hollow cone at proximal end
- 1 side channel for balloon inflating, ending in a non-return valve with Luer connection
- 1 balloon, inflatable
Material: Silicone coated, natural latex
Length: 40cm adults
Expanding balloon capacity: 15ml/adults
Catheter size and balloon capacity has to be mentioned on the catheter itself
Initial sterilization: ethylene oxide
Packaging: 1 urine catheter sterile, disposable
Must be supplied with double packaging: one interior layer plus sterilised peel pack
Labeling should mention:
Name and/or trademark of manufacturer, sterile, lot number, expiry date by year and month, "for single use", CE + number; product description
Other requirements: Meets the norm EN 1616



1125 CATHETER, URINARY, FOLEY, w/ balloon, CH 14, sterile, disp.

Tube designed to be inserted into the bladder cavity, via the urethra, in order to drain off urine, instill a liquid or irrigate the bladder

The catheter consists of a straight tube with:

- 1 central channel for urinary drainage, with 2 side holes opposite each other and a rounded tip at distal end and a truncated hollow cone at proximal end
- 1 side channel for balloon inflating, ending in a non-return valve with Luer connection
- 1 balloon, inflatable

Material: Silicone coated, natural latex

Length: 40cm adults

Expanding balloon capacity: 15ml/adults

Catheter size and balloon capacity has to be mentioned on the catheter itself

Initial sterilization: ethylene oxide

Packaging: 1 urine catheter sterile, disposable

Must be supplied with double packaging: one interior layer plus sterilised peel pack

Labeling should mention:

Name and/or trademark of manufacturer, sterile, lot number, expiry date by year and month,

"for single use", CE + number; product description

Other requirements: Meets the norm EN 1616

1126 CATHETER, URINARY, FOLEY, w/ balloon, CH 16, sterile, disp.

Tube designed to be inserted into the bladder cavity, via the urethra, in order to drain off urine, instill a liquid or irrigate the bladder

The catheter consists of a straight tube with:

- 1 central channel for urinary drainage, with 2 side holes opposite each other and a rounded tip at distal end and a truncated hollow cone at proximal end
- 1 side channel for balloon inflating, ending in a non-return valve with Luer connection
- 1 balloon, inflatable

Material: Silicone coated, natural latex

Length: 40cm adults

Expanding balloon capacity: 15ml/adults

Catheter size and balloon capacity has to be mentioned on the catheter itself

Initial sterilization: ethylene oxide

Packaging: 1 urine catheter sterile, disposable

Must be supplied with double packaging: one interior layer plus sterilised peel pack

Labeling should mention:

Name and/or trademark of manufacturer, sterile, lot number, expiry date by year and month,

"for single use", CE + number; product description

Other requirements: Meets the norm EN 1616

1127 CATHETER, URINARY, FOLEY, w/ balloon, CH 18, sterile, disp.

Tube designed to be inserted into the bladder cavity, via the urethra, in order to drain off urine, instill a liquid or irrigate the bladder

The catheter consists of a straight tube with:

- 1 central channel for urinary drainage, with 2 side holes opposite each other and a rounded tip at distal end and a truncated hollow cone at proximal end
- 1 side channel for balloon inflating, ending in a non-return valve with Luer connection
- 1 balloon, inflatable

Material: Silicone coated, natural latex

Length: 40cm adults

Expanding balloon capacity: 15ml/adults

Catheter size and balloon capacity has to be mentioned on the catheter itself

Initial sterilization: ethylene oxide

Packaging: 1 urine catheter sterile, disposable

Must be supplied with double packaging: one interior layer plus sterilised peel pack

Labeling should mention:

Name and/or trademark of manufacturer, sterile, lot number, expiry date by year and month, "for single use", CE + number; product description
Other requirements: Meets the norm EN 1616

1128 CATHETER, URINARY, FOLEY, w/ balloon, CH 20, sterile, disp.

Tube designed to be inserted into the bladder cavity, via the urethra, in order to drain off urine, instill a liquid or irrigate the bladder

The catheter consists of a straight tube with:

- 1 central channel for urinary drainage, with 2 side holes opposite each other and a rounded tip at distal end and a truncated hollow cone at proximal end
- 1 side channel for balloon inflating, ending in a non-return valve with Luer connection
- 1 balloon, inflatable

Material: Silicone coated, natural latex

Length: 40cm adults

Expanding balloon capacity: 15ml/adults

Catheter size and balloon capacity has to be mentioned on the catheter itself

Initial sterilization: ethylene oxide

Packaging: 1 urine catheter sterile, disposable

Must be supplied with double packaging: one interior layer plus sterilised peel pack

Labeling should mention:

Name and/or trademark of manufacturer, sterile, lot number, expiry date by year and month, "for single use", CE + number; product description

Other requirements: Meets the norm EN 1616

1129 CATHETER, URINARY, FOLEY, w/ balloon, CH 24, sterile, disp.

Tube designed to be inserted into the bladder cavity, via the urethra, in order to drain off urine, instill a liquid or irrigate the bladder

The catheter consists of a straight tube with:

- 1 central channel for urinary drainage, with 2 side holes opposite each other and a rounded tip at distal end and a truncated hollow cone at proximal end
- 1 side channel for balloon inflating, ending in a non-return valve with Luer connection
- 1 balloon, inflatable

Material: Silicone coated, natural latex

Length: 40cm adults

Expanding balloon capacity: 15ml/adults

Catheter size and balloon capacity has to be mentioned on the catheter itself

Initial sterilization: ethylene oxide

Packaging: 1 urine catheter sterile, disposable

Must be supplied with double packaging: one interior layer plus sterilised peel pack

Labeling should mention:

Name and/or trademark of manufacturer, sterile, lot number, expiry date by year and month, "for single use", CE + number; product description

Other requirements: Meets the norm EN 1616

1130 CATHETER, URINARY, THIEMANN, CH12

The urethral catheter consists of a hollow, transparent, cylindrical tube with:

- Central channel for urinary drainage
- Closed rounded distal end with two facing side windows
- Bent tip at distal end
- Proximal end with cup connector (conical tip)

Material: Polyvinyl
Without balloon
Length approx. 40 cm
Initial sterilization method: Ethylene oxide gas or Gamma radiation
Packaging and labeling: one (1) urethral catheter, sterilized, disposable
Must be supplied with double packaging: one interior layer plus sterilised peel pack
Name and/or trademark of manufacturer, sterile, lot number, expiry date by year and month, "for single use", CE + number; product description

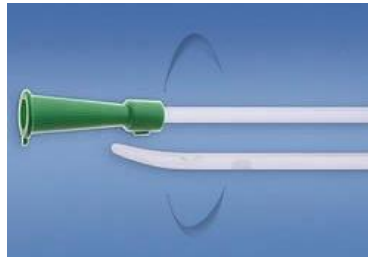

1131 CATHETER, URINARY, THIEMANN, CH16

The urethral catheter consists of a hollow, transparent, cylindrical tube with:

- Central channel for urinary drainage
- Closed rounded distal end with two facing side windows
- Bent tip at distal end
- Proximal end with cup connector (conical tip)

Material: Polyvinyl
Without balloon
Length approx. 40 cm
Initial sterilization method: Ethylene oxide gas or Gamma radiation
Packaging and labeling: one (1) urethral catheter, sterilized, disposable
Must be supplied with double packaging: one interior layer plus sterilised peel pack
Name and/or trademark of manufacturer, sterile, lot number, expiry date by year and month, "for single use", CE + number; product description

1132 CENTRIFUGE, for 8 x 15 ml tubes; up to 6000 rpm.

Like HETTICH EBA 20
Power: 115-230 V
Adjustable non-electrical speed regulation
Complete with 8-12 place angle head with shields and glass centrifuge tubes
With electro-mechanical timer 0-60 min
To be supplied with: glass centrifuge tubes
Spare parts: 1 set carbon brushes

1133 CENTRIFUGE, HAEMATOCRIT, with rotor (75mm)

Rapid rotating system used to centrifuge the haematocrit capillary tubes
Used for concentration technique in trypanosomiasis
Like Hettich type 20
Components: rotor for 24 capillaries (75mm) incl. evaluation disk in the cover
Material: double walled plastic housing and lid are mounted on a solid metal chase
Dimensions: (W x H x D) 231 x 198 x 292 mm
Weight 5.7 kg
Electric brake 115-230 V

Time display in sec. or min
Running time max. 99 min
Lid of haematocrit rotor is cover and evaluation disc in one
Brushless frequency drive
Max. Rotation speed: 13,000 rpm
Low speed from 100 RPM possible
To be used with: TUBE, CAPILLARY, MICRO-HAEMATOCRIT, 75 mm, heparinised
WAX FOR HAEMATOCRIT

1134 CENTRIFUGE, manual operated, 4x15 ml, incl. tubes

Hand operated apparatus for rapid rotation, used to separate two substances of differing density
Centrifuge for 5 min. to obtain a satisfactory deposit
Material:
- Base: cast iron or fiberglass
- Gear support structure: metal or fiberglass; heavy duty construction
Speed up to 3000 rotations/min
Bench clamp
4 polyamide buckets for 15 ml tubes
Swing rotor for 4x15 ml tubes

1135 CHAIR, FOLDABLE, ARMCHAIR, nylon seat and back

Type director's chair
Light weight frame



1136 CLAMP, UMBILICAL, sterile

Designed for clamping the umbilical cord immediately after birth
Material: non-toxic medical grade polymer
Provided with double purpose security lock and protection against mishandling
Provided with grooves all along the length
Disposable
Packaging and labeling: each clamp in sterile peel pack, should mention exp date, lot number, items description, size, type of sterilization, manufacturer name, ref number, CE + Nr, protective carton packing with same information and no. of units

1137 CLIP, X-RAY FILM

1138 CLOCK, kitchen type, incl batteries



1139 CLEANING, CLOTH (Wiping Mop)

Size: approx. 50 x 50 cm
Washable at 90°C
Material: Cotton

1140 COAT for medical personnel, size L, white, unisex

Work wear which is worn over clothing or a surgical tunic
Material: 100% cotton woven
Washing: up to 95°C, withstands boiling and steam sterilization, resists to chlorine 0,1 %
Features:
- Long sleeves
- Mandarin collar
- 1 breast patch pocket
- 2 lower patch pockets
- Mid-tight length
- Snap closure
Non sterile, multiple use

1141 COAT for medical personnel, size M, white, unisex

Work wear which is worn over clothing or a surgical tunic
Material: 100% cotton woven
Washing: up to 95°C, withstands boiling and steam sterilization, resists to chlorine 0,1 %
Features:
- Long sleeves
- Mandarin collar
- 1 breast patch pocket
- 2 lower patch pockets
- Mid-tight length
- Snap closure
Non sterile, multiple use

1142 COAT for medical personnel, size XL, white, unisex

Work wear which is worn over clothing or a surgical tunic
Material: 100% cotton woven
Washing: up to 95°C, withstands boiling and steam sterilization, resists to chlorine 0,1 %
Features:
- Long sleeves

- Mandarin collar
- 1 breast patch pocket
- 2 lower patch pockets
- Mid-tight length
- Snap closure
- Non sterile, multiple use



1143 COLD BOX, 20.7 l VAC., Electrolux RCW25 + 24 Ice Packs 0.6 l

Cold box for storage of vaccines for several days, long range

Vaccine storage capacity: 20.7 litres

Weight fully loaded: 32.8kg

Weight empty: 17kg

External surface material: Polyethylene

Internal lining material: Polyethylene

Insulation material Polyurethane foamed with cyclopentane

Insulation thickness: 105 mm

External dimensions: 71x55x50cm

Internal dimensions: 50x34x27cm

Vaccine storage dimensions: 42x26x19cm

Lid type and fixings: hinged

Robustness in drop test: fittings 2, casing 5

Cold life without openings 181 hrs at +32°C, 130 hrs at +43°C

Since 1998 this item is coloured in blue, as opposed to yellow previously

When ordering spare parts, please indicate the product number

Number of icepacks required: 24

Other requirements: meets WHO/UNICEF Standard

To be supplied with: 24 ICE PACK, 0.6 l, Electrolux, empty, to be filled with H2O



1144 Vaccine Carrier, long range

Cold box for storage of vaccines for hours, long range
Vaccine storage capacity: 3.0 litres
Weight fully loaded: 7.3 kg
Weight empty: 3.1 kg
External dimensions: 36.2x28.3x29.9cm
Internal dimensions: 21.1x10.9x15.7cm
Vaccine storage dimensions: 21.1x10.9x15.7cm
Lid type and fixings: hinged
External surface material: Polyethylene
Internal lining material: Polyethylene
Insulation material: Polyurethane foam
Insulation thickness: 23-27mm
Number of icepacks required 6 x 0.3 L + 1 x 0.6 L
Number of icepacks supplied 6 x 0.3 L + 1 x 0.6 L
Icepack type required Compliant with E05/IP01-VP.1
Robustness in drop test: fittings 2, casing 1
Cold life without openings (up to 10°C) 30.3hrs at +43°C, 6.7hrs at +43°C
Since 1998 this item is coloured in blue, as opposed to yellow previously
When ordering spare parts, please indicate the product number
Meets requirements: WHO/PQS/E04/VC01-VP.1
To be supplied with: 6 ICE PACK, 0.3L +0.6L, empty, to be filled with H2O

1148 COMPRESS, GAUZE, 10 x 10 cm, 8 plys, 17 thr., ster., 2 pcs

Material: bleached purified textile, plain weave absorbent gauze, 100% cotton
Type of gauze: 17 threads/cm² (23 g/m²)
Number of plys: 8 - 12
Thread count in cm² / square inch
- Warp: 9 thread /cm²; 26/24 thread/square inch
- Weft: 8 thread /cm²; 18/20/square inch
Surgical folding: no free threads apparent after folding or when the first layer is opened
Sterile
Non-detectable by X-ray
Primary packaging and labeling:
- 2 compresses, sterile in a peel pack sachet
- Name and/or trademark of the manufacturer, sterile, lot number, expiry date by year and month, "for single use", CE + number, product description
Secondary packaging:
- Protected unit, one (1) box of 40/50 sachets of 2 compresses
- Labeling to be the same as primary packaging
Extra information required:
- Number of units per secondary packaging
- Information for particular storage conditions (temperature, pressure, light, humidity, etc.) as appropriate (or equivalent)
Other requirements: Meets Pharmacopoeia specifications

1149 COMPRESS, GAUZE, 10 x 10 cm, 8 plys, 17 threads, non-ster.

Material: 100% hydrophilic cotton, medical grade, bleached purified, woven, plain weave
Type of gauze: 17 threads/cm² or 44 thread by square inch
Thread count in cm² / square inch

- Warp: 9 thread /cm²; 26/24 thread/square inch
 - Weft: 8 thread /cm²; 18/20/square inch
- Weight: minimum 23 g/m²
With selvedge to avoid the gauze to fray
Number of folds (thickness): 8 - 12
Surgical folding: no free threads appear after folding and when first outside fold is opened
Non-detectable by X-ray
Packaging: paper packet of 100 compresses, packed in suitable carton box
The following information must appear on the label of each packet:
- folded dimensions
 - type of gauze
 - no of ply
- Other requirements:** meets Pharmacopoeia specifications



1150 COMPRESS, LAPAROTOMY, 40x40 cm, X-ray detectable, loop

- Sterile compress with high absorption capacity used to absorb blood and various exsudates during surgical operation
Material: absorbent gauze, 100% cotton, bleached, purified, plain weave
Thread count:
- Warp: 95 to 105 treads / 10cm
 - Weft: 66 to 75 threads / 10 cm
 - 17 threads /cm²
- Weight / m²: 23 g
4 layers
Edges folded over and sawn, giving high strength and preventing any loose threads
With loop for holding
X ray detectable
Pre-washed for better absorption
Packaging: 1 compresses, sterile in a peel pack sachet
Other requirements: Meetes the European Pharmacopoeia specifications



1151 CONNECTOR, TUBES, biconical, symmetric. ext dia. 7 to 11 mm, autocl.

Bi-conical connector, straight, transparent or opaque used to connect catheters and tubes of different diameters

Material: Polycarbonate

Rigid tube, 5 cm long, with external diameter increasing from each end toward the centre

External \varnothing (d1) 7 mm, (d2) 11 mm

Non-sterile, autoclavable

Packaging: in plastic bag

Each bag to be clearly marked with the name and characteristics of the article and number of units per bag



1152 CONTAINER, INFECTIOUS SUBSTANCES, for transport, 1 litre

The bio-container allows to ship infectious substances (items identified as class 6, division 5.2 from international IA TA regulation)

Material: Outside layer carton case, reinforced with 2 carton plate on 4 sides and top

Plastic container watertight/airtight/dustproof

Container closure: tap screw type with gasket seal

1 Absorbing tissue: 160 x 280 mm

External dimension: 200 x 200 x 200 mm

Internal dimension: 100 x 100 x 100 mm

Transport conditions: Room temperature



1153 SHARP CONTAINER, Plastic, for used syringes and needles, 5l

Material: heavy-duty plastic;
able to close with a tight-fitting
puncture-resistant lid, without sharps being able to come out
upright and stable during use
Leak-resistant.
Self-locking and sealable
Properly labeled to warn of hazardous waste inside the container



1154 COTTON STICK, sterile

Cotton sticks are used to prepare urethral or vaginal smears

Material: cotton tip on wooden or PP stick
Sterile, disposable
Length: 150 mm
Individually packed
Packaging: in sterile peel pack, indicating expiry date



1155 COUNTER, MULTIPLE BANK, differential, 9 keys, + totalizing, mechanical

Mechanical instrument to count simultaneously 9 different leukocyte parameters
9 counters of 3 digits
1 totalizing machine of 3 digits with warning every 100 units
Reset button
Material: metallic case

1156 COUNTER, 'TALLY', mechanical, 1 button (0-9999)

Mechanical instrument used for counting elements (white blood cells, parasites)
Material: plastic or chromium -plated steel case
4 digits counter (0-9999)
Reset button
Case with stand and ring



1157 COUNTING CHAMBER, FUCHS-ROSENTHAL, depth 0.2mm, simple grid

The Fuchs-Rosenthal counting chamber is used to count white and red blood cells in CSF
Modified double- engraved bright line grid
Material: glass
- Depth 0.2 mm
- Volume: 3.2 mm³
With two haemocytometer glass cover slides (re-usable)
Packaging: protective packaging
To be used with: counting chamber COVER GLASS PLANED 22 x 26 x 04 mm

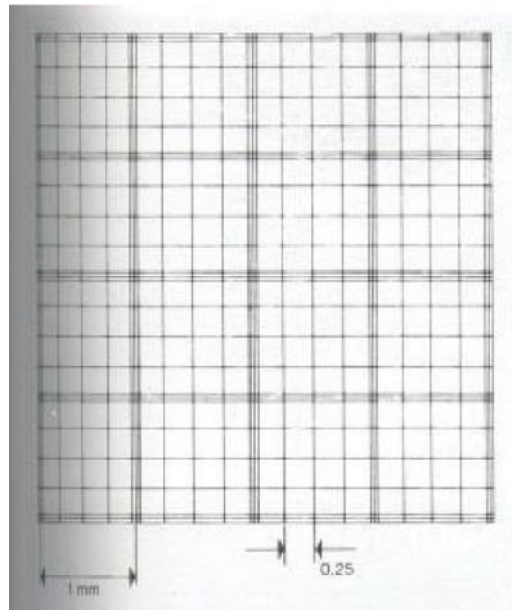

1158 COUNTING CHAMBER, NEUBAUER, modified model, depth 0.1 mm

The Neubauer counting chamber is used to count white blood cells by observing through the microscope a calibrated grid of lines

Material: glass

Modified model

Bright line with two haemocytometer glass cover slips (re-usable)

Double engraved bright line grid

Depth: 0.1 mm

Volume 0.9 mm³

To be used with: Counting chamber COVER GLASS PLANED 22 x 26 x 04 mm

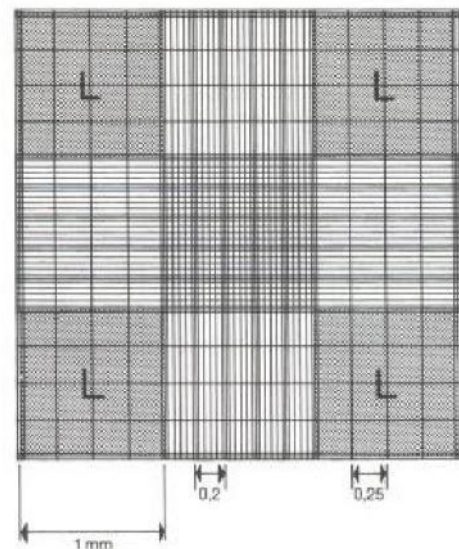
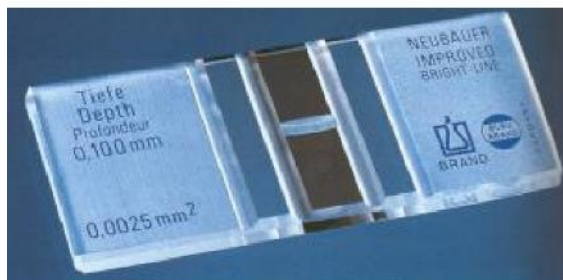

1159 COVER FOR BOHLER BRAUN, 40 - 60 cm

Material: cotton

To be used with: SPLINT, BOHLER-BRAUN, 40 - 60 cm, size 1, foldable

1160 COVER FOR BOHLER BRAUN, 60 - 80 cm

Material: cotton

To be used with: SPLINT, BOHLER-BRAUN, 60 - 80 cm, size 2, foldable

1161 COVER SLIP, 22 x 22 mm

Thin glass slide to place on a slide in order to cover a preparation

Cover slip 22 x 22 mm is the standard routine size

Material: cover slips glass

Non-sterile, single use only (washing not recommended)



1162 COVER SLIP, 50 x 25 mm

Cover slips 50 x 25 mm is only used to make collection slides

Material: cover slips glass

Non-sterile, single use only (washing not recommended)

1163 CRUTCH, elbow, high 74/97 cm, pair

For either short term or long-term use

High-strength aluminium

Orthopedic handle for user comfort

Forearm cuffs: vinyl coated

Adjustments to the handgrip and the cuff height can be made independently

Handle to armband: 18-25 cm

Handle to ground adjustable from: 66-92 cm

Maximum user weight: 160 Kg

Ferrule Size: 22 mm

Weight: approx. 585 g



1164 CYLINDER, MEASURING, PLASTIC, 100 ml

Cylindrical recipient to measure volumes, used for preparation of reagents and stains as well as for dilutions

Material: PMP, clear

Graduated: subdivision 1 ml

Resistant to steam sterilization



1165 CYLINDER, MEASURING, PLASTIC, 250 ml

Cylindrical recipient to measure volumes, used for preparation of reagents and stains as well as for dilutions

Material: PMP, clear

Graduated: subdivision 2 ml

Resistant to steam sterilization

1166 CYLINDER, MEASURING, PLASTIC, 500 ml

Cylindrical recipient to measure volumes, used for preparation of reagents and stains as well as for dilutions
Material: PMP, clear
Graduated: subdivision 5 ml
Resistant to steam sterilization

1167 CYLINDER, MEASURING, PLASTIC, 1000 ml, design high

Cylindrical recipient to measure volumes, used for preparation of reagents and stains as well as for dilutions
Material: PMP, clear
Graduated: subdivision 10 ml
Resistant to steam sterilization

1168 DEFIBRILLATOR, with ECG monitor, synchronized

Semi-automatic external defibrillator with manual and keypad in English
Built to withstand harsh environments
Resistant to dust and water jets (IP55 Rating)
3-lead cable ECG monitoring with and high-quality display (3 wave forms simultaneously)
Built-in ECG printer
Power supply: rechargeable batteries
Internal or USB memory data storage
With pulse oxymeter (SpO₂)
Shock frame with handle
To be supplied with: 1 set of detachable, reusable hard paddles
3 tubes of approx 100 g of electrode gel
2 three-lead ECG cable
10 rolls of ECG paper
100 ECG electrodes
2 finger clip sensor for pulse oxymeter, with cable, reusable
1 carrying case

1169 DERMATOME, electric, complete set

Precise cut thicknesses up to 0.76mm
0.05mm increments
Easily adjustable
Components:
- Handle
- Width plates: 30, 50, 80 1000 mm
- Power supply
To be supplied with: Screwdriver
10 screws for cutting plate
Sterilizing case

1170 DETERGENT, household, multipurpose

For general cleaning, liquid
Product must be fit for human utilisation and be of sound, fair and marketable quality

Cleaning capability: in ml per litre of water, manufacturer recommended dose
Anionic + non-ionic: 15% minimum on normal product, 35% on concentrated product
PH: max 10
Skin-irritating effect: none
Packing:
- 5 litre polyethylene bottle, hermetically sealed
- Bottle to have caps with tamper proof devices
- No leakage under the pressure of two stacked pallets
Marking: Includes warnings and dilution recommendation

1171 DEVELOPER, powder, for 22.5 litres

Concentrated developer in powder form for dilution to make 22.5 l of working solution
The quantity to be used for the development of the X-Ray films is about 1 liter/m²
22.5 liters can develop:

- ± 312 films of 24 x 30cm
- ± 188 films of 30 x 40cm
- ± 150 films of 36 x 43cm

Storage:

- once prepared, the developer solution should be used within the 2 coming months and kept between 15° C and 18° C
- protected from sunlight and air to avoid oxidation

Packaging:

- sealed plastic bag to protect from humidity
- product is corrosive for air transport, packing should be in accordance with IATA rules

Labeling:

- clear and explicit instructions should appear on the label
- marked with lot number and expiry date

To be used with: DEVELOPING UNIT, X-RAY, manual, w/ 4 basins, + accessories
DEVELOPING UNIT, X-RAY, automatic
BUCKET, 23 to 26 litres, with lid

1172 DEVELOPING UNIT, X-RAY, automatic

Medium duty table top machine of up to 20 films per hour
Adjustable film dryer temperature
Suitable for 14 x 17" (360 x 430 mm) film sheets
Digital display of developer bath temperature
Wired for 230 VAC, 50 Hz
European plug

1173 DEVELOPING UNIT, X-RAY, manual, w/ 4 basins, + accessories

Manual film processor for field hospital and for X-ray department with poor electricity supply or as emergency unit
Processing tanks set for film hangers up to 35 x 43 cm
2 tanks, 20 litres each with lead and drain cock
1 tank, 30 litres with inlet and overflow
1 drip tray with drain system (counted as 4th basin)
1 Plastic tube diameter 15mm, length 2m
Material: all tanks in PVC
To be supplied with: 1 connection set:
with 2 m flexible tube 16mm ID for inlet + 2 m

flexible tube 25 mm ID for overflow
4 tube clamps
Net weight: approx 20kg
Space required approx 50 x 56x 65cm



1174 DEVICE FOR TRACTION, to be fixed on BED OR SPLINT

Traction device for attachment to BOHLER BRAUN splint or hospital bed
To be used with: SPLINT, BOHLER-BRAUN (both sizes) or HOSPITAL BED

1175 DIAPER CHANGING TABLE, dismantable construction

Material:
- Frame: stainless steel
- Trays: plastic
Size: approx. 85 x 50 x 100 cm
Foam cushion with Nylon cover (according to EN 71-3)
Easy to clean
Foam cushion: approx. 46 x 83 cm
Overall weight: approx. 12 kg
4 castors



1176 DIAPER, Maxi, 18kg

Disposable nappies for single use
For babies with a body weight from 18 kg onwards

1177 DIAPER, Midi, 9kg

Disposable nappies for single use
For babies with a body weight from 9 kg onwards

1178 DIAPER, Mini, 6kg

Disposable nappies for single use
For babies with a body weight from 6 kg onwards

1180 DISINFECTANT, HAND, bottle 1 ltr, w/ dispenser

100 g contains: 45,0 g 1-propanol; 28,0 g 2-Propanol; 0,3 g lactic acid, water, glycerol
Similar products for hand disinfection might be acceptable



1181 DISPENSER, for cellulose swabs

To provide single use and hygienic withdrawal, to avoid contamination of swabs
Material: plastic



1182 DISPENSER, for sterilization tape

Dispenser is made of rugged, high-impact, durable plastic and is capable of handling one roll of up to 2.5 cm wide indicator tape

1187 DOPPLER, FETAL HEART DETECTOR, pocket, w/2Mhz probe, AA bat.

Used throughout pregnancy and labour. For maternity or Health Centre

Like: HuntLeigh FETAL DOPPLEX I (FD1) or: Sonicaid One

Pocket obstetric Doppler:

LCD screen shows foetal heart rate in beats per minute along with a symbol that flashes with each detected foetal heart beat

Permanent 2 Mhz waterproof probe with recessed storage

Extended life battery with low-battery indicator

Two auto-shut off features that enable to get optimal battery life

Dimension approx L/W/D 140x74x27 mm

Battery: AA

To be supplied with: soft carry pouch
stereo headphones
gel
neck-cord
battery



1188 DOSIMETER, pen

An instrument that measures and indicates the amount of x-rays or radiation absorbed in a given period

To be suitable for monitoring accumulative doses of X-Ray radiation in hospital environment

With metal clip

Pen-type, pocket size

Direct readout

Hermetically sealed, immersion proof

Other requirements: meet military specifications for the RADIAC METER IM-264/PD and ANSI N 13.5 and N322 requirements



1189 DRAIN, REDON, CH 10, 50 cm, perf. length 14 cm, sterile, disp.

Material: Transparent PVC, flexible
Terminal, atraumatic end
Several lateral eyes
Radio-opaque line
Packaging: sterile unit packaging

1190 DRAIN, REDON, CH 14, 50 cm, perf. length 14 cm, sterile, disp.

Material: Transparent PVC, flexible
Terminal, atraumatic end
Several lateral eyes
Radio-opaque line
Packaging: sterile unit packaging

1191 DRAIN, SUPRA PUBIC, CH10, puncture set, compl., ster, disp.

For non-operative drainage (temporary or long term) of the urinary bladder when the passage of a urethral (Foley) catheter is not possible: enlarged prostate; fracture of the pelvis with rupture of the prostate urethra; injury to penis; obstetric perineal trauma, fistulae
Complete set for inserting supra-pubic catheter

Components:

- 1 Catheter, pigtail end, with balloon
- 1 Puncture needle/trocard
- 1 scalpel
- 1 urine bag 2 l
- 1 clamp or plug
- 1 adhesive tape
- 1 wire guide
- 1 Catheter stopper

Material:

- Catheter: 100% silicone
- Puncture needle/trocard: stainless steel
- Wire guide: stainless chrome nickel steel
- Urine bag: Polyvinyl chloride (PVC)

Catheter:

- Semi flexible hollow cylindrical tube with central channel (for urine drainage) and a side

- channel (to inflate the balloon) ending on a none-return valve device with Luer connection
- Length: 510-650mm with 6 lateral eyes and curled open tip (pigtail) to act as an anchor in the bladder
 - Diameter: CH10 (3,3mm)
 - Balloon: 3-5 ml (CH10)
- Puncture needle:
- To perforate the abdominal wall, as far as the bladder enabling catheter insertion
 - Pre-split sheath, sharp long lance-shaped tip
 - Colour code on wings: white CH10
- Urine bag:
- 2 liters volume with 100 ml graduated scale
 - kink resistant tubing and emptying valve system and tubing clamp
- Wire guide:
- Diam. 1.1 mm
 - Length 1000mm
 - Shape: spiral
- Plug: to close supra-pubic catheter when needed
- Adhesive tape: adapted to catheter size for quick and safe attachment on abdominal wall
- Initial sterilization: Ethylene oxide (EO)
- Packaging: sterile, peel-packs, disposable
- Labeling should mention: name and/or trademark of the manufacturer, sterile, lot number, expiry date by year and month, "for single use", CE + number; product description
- Other requirements:** Conform to norm EN 1617 and EN 1618



1192 DRAIN, THORACIC, CH 16, straight, 50 cm, sterile, disposable

- Material: transparent medical Polyvinyl chloride (PVC)
- Kink-resistant smooth
- Length: 50 cm
- Radio-opac broken line (Sentinel line): broken at the first proximal eye (Sentinel eye)
- Numerical graduations: every 2 cm
- Eyes: 4 lateral, atraumatic (holes)
- Distal end/tip: atraumatic. round end, open
- Proximal end/tip: bevelled for atraumatic tissue crossing
- Diameter: 5.3 mm
- Packaging: 1 catheter, sterile, disposable
- Must be supplied with double packaging: one interior layer plus sterilised peel pack
- Labeling should mention: name and/or trademark of the manufacturer, sterile, lot number, expiry date by year and month, "for single use". CE + number; product description
- Other requirements:** Manufacturer has to be ISO certificated: ISO: 9001/EN46001 or ISO 9002/EN 46002, class IIa



1193 DRAIN, THORACIC, CH 28, straight, 50 cm, sterile, disposable

Material: transparent medical Polyvinyl chloride (PVC)
Kink-resistant smooth
Length: 50 cm
Radio-opac broken line (Sentinel line): broken at the first proximal eye (Sentinel eye)
Numerical graduations: every 2 cm
Eyes: 6 lateral, atraumatic (holes)
Distal end/tip: atraumatic. round end, open
Proximal end/tip: bevelled for atraumatic tissue crossing
Diameter: 8,0 mm
Packaging: 1 catheter, sterile, disposable
Must be supplied with double packaging: one interior layer plus sterilised peel pack
Labeling should mention: name and/or trademark of the manufacturer, sterile, lot number, expiry date by year and month, "for single use". CE + number; product description
Other requirements: Manufacturer has to be ISO certificated: ISO: 9001/EN46001 or ISO 9002/EN 46002, class IIa

1194 DRAIN, THORACIC, CH 32, straight, 50 cm, sterile, disposable

Material: transparent medical Polyvinyl chloride (PVC)
Kink-resistant smooth
Length: 50 cm
Radio-opac broken line (Sentinel line): broken at the first proximal eye (Sentinel eye)
Numerical graduations: every 2 cm
Eyes: 6 lateral, atraumatic (holes)
Distal end/tip: atraumatic. round end, open
Proximal end/tip: bevelled for atraumatic tissue crossing
Diameter: 10,6 mm
Packaging: 1 catheter, sterile, disposable
Must be supplied with double packaging: one interior layer plus sterilised peel pack
Labeling should mention: name and/or trademark of the manufacturer, sterile, lot number, expiry date by year and month, "for single use". CE + number; product description
Other requirements: Manufacturer has to be ISO certificated: ISO: 9001/EN46001 or ISO 9002/EN 46002, class IIa

1195 DRAINAGE, THORACIC, BOTTLE, 2 ltr, 2 chamber, with tubing

Underwater seal chest drainage bottle, sterile, disposable
To be used after chest surgery, chest trauma i.e. pneumo- and haemotothorax, empyema

Components:

- Bottle with integral handle, removable protective cap
- Adjustable straw
- Bed hangers
- Disposable stand
- Tubing Sets

Material:

- Bottle: PVC
- Tubing: Translucent silk-finish PVC

Bottle with 2 chambers and 2000 ml overall capacity

Small chamber:

- 500 ml with clearly marked Prime Level (water seal = 200ml)
- Allows accurate measure for the first 500ml, which is important for children
- Adjustable graduated straw
- Screw cap with rubber gasket to secure water seal tightness

Large chamber:

- 1500 ml for complementary drainage
- Write-on strip alongside each chamber, with scale for continuous monitoring of drainage progress

Venting/Suction port:

- With removable protective cap, none occluding
- The port is situated on the top of the bottle for easy checking protection

1 bottle, sterile, disposable

Packaging: must be supplied with double packaging: one interior layer (non woven drape) plus sterilized peel pack

Labeling should mention: name and/or trademark of the manufacturer, sterile, lot number, expiry date by year and month, "for single use". CE + number; product description

Other requirements: When using a suction machine: maximum vacuum recommended is 5kPa

Chest drainage bottle can withstand a maximum vacuum of 13kPa (check with supplier's instructions to use)



1196 DRAINAGE, TUBING, abdominal, 15 mm x 600 mm, disposable

Flexible tube to drain off sera, blood, secretions etc from the abdominal area

The radiopaque line facilitate the catheter location when visualized by X-Ray
Lateral holes at the two ends of the tube ensure much drainage and irrigation
Good biocompatibility
Material: medical grade silicone rubber
Packaging: must be supplied in sterilized peel pack

1197 DRAPE, COVER INSTRUMENT TABLE, cotton, approx 80 x 145 cm

Bag-shaped instrument table cover for TABLE, INSTRUMENTS, 60 x 48 cm, Mayo type
Material: 100% cotton or 50% cotton and 50% polyester

Reusable woven fabrics

Designation: 100% cotton cretonne fabric

- Number of threads/cm: warp: 24, weft: 24
- Metric count: warp: 28, weft: 28
- Weight per m2: 180 g

Polyester/ cotton:

Designation: Woven cotton 50% cotton / 50% polyester fabric, heat set

- Number of threads/cm: warp: 24, weft: 22
- Metric count: warp: 28, weft: 28
- Weight per m2: 175g

Both woven fabric material are suitable for normal washing, withstand boiling & autoclaving and are resistant to chlorine 5%.

Colour: green

Hemmed borders

Non-sterile multiple use

Packaging: protected in a plastic bag, single or multiple unit

Other requirements: meets G1 DIN 61621

To be used with: TABLE, INSTRUMENTS, 60 x 48 cm, Mayo type

1198 DRAPE, COVER INSTRUMENT TABLE, non-woven, sterile, disposable

Material: non woven fabric (cellulose/polyester) and polyethylene

Bag-shaped instrument table cover for Mayo table in OT

Size: approx. 80 x 145 cm

Disposable

Without hole

Packaging and labeling: each drape in sterile peel pack, should mention exp date, lot number, items description, size, type of sterilization, manufacturer name, ref number, CE + Nr, protective carton packing with same information and no. of units

To be used with: TABLE, INSTRUMENTS, 60 x 48 cm, Mayo type

1199 DRAPE, SURGICAL, 50 x 60 cm, with hole, disposable, sterile

For surgery; to maintain aseptic conditions in the operative field

Non woven fabric (cellulose/polyester) and polyethylene

Disposable

With hole

Two or three layer material:

- The top layer of highly absorbent non-woven fabric
- The intermediate or second layer is of impermeable material (example polyethylene) acts as a 100% germ barrier against bacterial migration and soaking
- The bottom layer (3rd) of absorbent tissue absorbs the patient's sweat

Packaging and labeling: each drape in sterile peel pack, should mention exp date, lot

number, items description, size, type of sterilization, manufacturer name, ref number, CE + Nr, protective carton packing with same information and no. of units



1200 DRAPE, SURGICAL, 75 x 90 cm, disposable, sterile

For surgery; to maintain aseptic conditions in the operative field

Non woven fabric (cellulose/polyester) and polyethylene

Disposable

Without hole

Two or three layer material:

- The top layer of highly absorbent non-woven fabric
- The intermediate or second layer is of impermeable material (example polyethylene) acts as a 100% germ barrier against bacterial migration and soaking
- The bottom layer (3rd) of absorbent tissue absorbs the patient's sweat

Packaging and labeling: each drape in sterile peel pack, should mention exp date, lot number, items description, size, type of sterilization, manufacturer name, ref number, CE + Nr, protective carton packing with same information and no. of units



1201 DRAPE, SURGICAL, 75 x 90 cm, with hole, disposable, sterile

For surgery; to maintain aseptic conditions in the operative field

Non woven fabric (cellulose/polyester) and polyethylene

Disposable

With hole

Two or three layer material:

- The top layer of highly absorbent non-woven fabric
- The intermediate or second layer is of impermeable material (example polyethylene) acts as a 100% germ barrier against bacterial migration and soaking
- The bottom layer (3rd) of absorbent tissue absorbs the patient's sweat

Packaging and labeling: each drape in sterile peel pack, should mention exp date, lot number, items description, size, type of sterilization, manufacturer name, ref number, CE + Nr, protective carton packing with same information and no. of units

1202 DRAPE, SURGICAL, 150 x 180 cm, disposable, sterile

For surgery; to maintain aseptic conditions in the operative field

Non woven fabric (cellulose/polyester) and polyethylene

Disposable

Without hole

Two or three layer material:

- The top layer of highly absorbent non-woven fabric
- The intermediate or second layer is of impermeable material (example polyethylene) acts as a 100% germ barrier against bacterial migration and soaking
- The bottom layer (3rd) of absorbent tissue absorbs the patient's sweat

Packaging and labeling: each drape in sterile peel pack, should mention exp date, lot number, items description, size, type of sterilization, manufacturer name, ref number, CE + Nr, protective carton packing with same information and no. of units

1203 DRAPE, SURGICAL, cotton, 75 x 90 cm, with hole, green

For surgery; to maintain aseptic conditions in the operative field

Material: 100% cotton or 50% cotton and 50% polyester

Reusable woven fabrics

Designation: 100% cotton cretonne fabric

- Number of threads/cm: warp: 24, weft: 24
- Metric count: warp: 28, weft: 28
- Weight per m2: 180 g

Polyester/ cotton:

Designation: Woven cotton 50% cotton / 50% polyester fabric, heat set

- Number of threads/cm: warp: 24, weft: 22
- Metric count: warp: 28, weft: 28
- Weight per m2: 175g

Both woven fabric material are suitable for normal washing, withstand boiling & autoclaving and are resistant to chlorine 5%

Hole with hemmed border diameter +/- 7 cm

Colour: green

4 hemmed borders

Non-sterile multiple use

Packaging: protected in a plastic bag, single or multiple unit

1204 DRAPE, SURGICAL, cotton, 75 x 90 cm, without hole, green

For surgery; to maintain aseptic conditions in the operative field

Material: 100% cotton or 50% cotton and 50% polyester

Reusable woven fabrics

Designation: 100% cotton cretonne fabric

- Number of threads/cm: warp: 24, weft: 24
- Metric count: warp: 28, weft: 28
- Weight per m2: 180 g

Polyester/ cotton:

Designation: Woven cotton 50% cotton / 50% polyester fabric, heat set

- Number of threads/cm: warp: 24, weft: 22

- Metric count: warp: 28, weft: 28
 - Weight per m2: 175g
- Both woven fabric material are suitable for normal washing, withstand boiling & autoclaving and are resistant to chlorine 5%.
Colour: green
4 hemmed borders
Non-sterile multiple use
Packaging: protected in a plastic bag, single or multiple unit

1205 DRAPE, SURGICAL, cotton, 120 x 160 cm, without hole, green

- For surgery; to maintain aseptic conditions in the operative field
Material: 100% cotton or 50% cotton and 50% polyester
Reusable woven fabrics
Designation: 100% cotton cretonne fabric
- Number of threads/cm: warp: 24, weft: 24
 - Metric count: warp: 28, weft: 28
 - Weight per m2: 180 g
- Polyester/ cotton:
Designation: Woven cotton 50% cotton / 50% polyester fabric, heat set
- Number of threads/cm: warp: 24, weft: 22
 - Metric count: warp: 28, weft: 28
 - Weight per m2: 175g
- Both woven fabric material are suitable for normal washing, withstand boiling & autoclaving and are resistant to chlorine 5%.
Colour: green
4 hemmed borders
Non-sterile multiple use
Packaging: protected in a plastic bag, single or multiple unit

1206 DRILL, electric, bone surgery

- Cordless orthopaedic drill
Like 'MAKITA 6018D'
Complete kit including:
- Stainless steel chuck (6.35mm capacity) and extension (6 cm)
 - 2 batteries
 - Charger
 - Autoclavable shroud
 - Case
- Speed control 0-600rpm via trigger
Low speed, high torque
Weight incl. battery: approx.1100 g
To be supplied with: autoclavable cover, green surgical cotton material
To be used with: EXTERNAL FIXATOR, set for 2 femurs and 3 tibias incl. instruments



1207 DROPPING BOTTLE, POLYETHYLENE, soft, 100ml, with dropper cap

Used to store staining reagents and to perform staining procedures
With long tip and captive cap

1208 DRUM, STERILIZING, 18 cm, diam. 17 cm, filter in top and bottom

Material: stainless steel
Design according to Konrich
With hinged lid
Carrying handle on lid
Adequate seal of the lid
Reusable filter in top and bottom
To be used with: AUTOCLAVE, COMBINED, 90 l, elec./kero.
Four should fit in the chamber at one level
Size optimized for this sterilizer

1209 DRUM, STERILIZING, 18 cm, diam. 34 cm, filter in top and bottom

Material: stainless steel
Design according to Konrich
With hinged lid
Carrying handle on lid
Adequate seal of the lid
Reusable filter in top and bottom
To be used with: AUTOCLAVE, COMBINED, 90 l, elec./kero
3 should fit on top of each other in the chamber

1210 DRUM, STERILIZING, 28 cm, diam. 34 cm, filter in top and bottom

Material: stainless steel
Design according to Konrich
With hinged lid
Carrying handle on lid

Adequate seal of the lid

Reusable filter in top and bottom

To be used with: AUTOCLAVE, COMBINED, 90 l, elec./kero
Two should fit in the chamber
Size optimized for this sterilizer



1211 HEATER, electric, for changing table

Electric heating element for children's changing table

Automatic safety turn-off after 10 min

Power supply: 220-240 V ~/ 50 Hz

Nominal power consumption: 600 Watt

IP Protection type: X2

Dimensions approx.: (L x W x H): 640 x 140 x 100 mm

Weight: approx. 1,2 kg

Power cable length: 180 cm

Pull switch length: 40 cm

Swivel range: 15° upwards, 32° downwards



1212 ELECTROCARDIOGRAPH, 3 channel

Measurements, interpretation and memory are available in any combination to meet specific customer needs

One-touch operation for acquisition, analysis, storage and printing minimizes training

12 Lead
4 user-definable fields for patient data entry flexibility
Waveform display allows rapid assessment of ECG rhythm and signal quality
Portable, lightweight design with carry handle allows the device to be easily taken wherever it is needed
Full-size paper accommodates multiple standard report formats
Optional archivist paper available for longer-term ECG storage
Battery powered for added versatility
Optional CT (Clinical Trial) data guard feature is designed to help guarantee the integrity of the digital ECG record, support facilitation of 21 CFR Part 11 compliance, enhance security and protect electronic records
Other requirements: compliant with 93/42/ECC, EN 60601-1-2
To be supplied with: manual rubber suction electrodes for chest (V1 - V6) and clamps or rubber band for extremities
10 tubes of electrode gel
10 rolls of spare paper

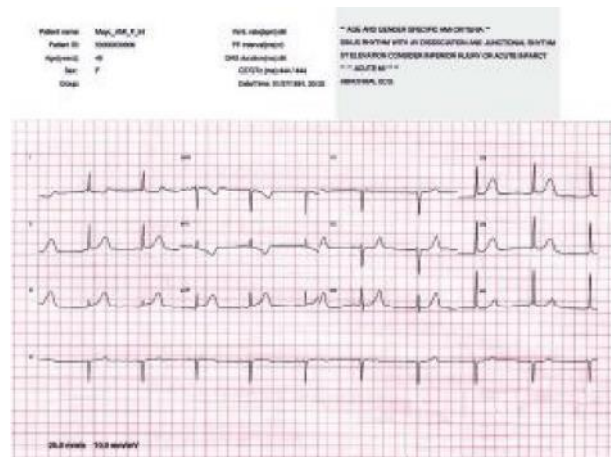

1213 ELECTROSURGICAL UNIT, 300W

Electrosurgical unit for cutting and coagulating (monopolar and bipolar) during surgery (major and minor)

- Switch-mode power supply
- Automatic power shut-off in the event of malfunction
- No opening or cooling fans, no fans, equipment must be efficient for minimal drop in output
- Clearly arranged controls and visible, easy-to-understand symbols
- Digital display for the settings

Cutting:

- Choice of settings from smooth cutting to heavy cutting
- Power up to approx 300 W

- Coagulation:

- High power for contact coagulation
- Current with high crest factor for spray coagulation
- Power up to approx 120 W
- separate generator for bipolar coagulation

Bi-coagulation generator usable simultaneously with the generator for cutting/coagulation

Variable output (continuous) for all seven current types

Sockets for proprietary and disposable coaxial cable

Reusable neutral electrode

Set of reusable and autoclavable instruments and tips for active electrode

All connections for active, neutral electrodes and footswitch on the front panel

Alarms:

- visual and acoustic signs for HF activation by different coloured indicators and different acoustic tones for cutting and coagulation
- acoustic warning feature in high frequency activation > 15sec
- availability of safety feature in case of malfunction

Power: 220-240 V @ 50Hz, 800VA max.

Additional requirements: IEC approved Class I, Type CF/Defibrillation protected



1216 ENTELLAN NEW

Rapid mounting media for microscopy used to prepare demonstration material and long lasting sample slides for teaching purposes

DGR UN 1866

Colorless liquid

Xylene solution, Toluene

DG (Dangerous Goods: Class 3):

- Xn: harmful to health
- R10 -21: flammable, harmful in contact with skin
- R31-38: irritating to eyes and skin and inhalation
- S25-36/37: avoid contact to eyes, wear suitable protective clothing and gloves
- S46: if swallowed, seek medical advice immediately and show the container or label

Storage:

- Store at room temperature +15°C - 25°C; keep away from sources of ignition and heat

Transport:

- Packing group III; store in tightly closed containers in a well ventilated place
- UN Number: UN1866
- UN Proper Shipping Name: Resin Solution
- Class and Subsidiary risk: 3
- Hazchem Code: 3Y

Packaging: 100ml glass or plastic bottle in protective wrapping, expiry date on the bottle

1217 ENVELOPE, for X-RAY FILM, 370 x 450 cm, kraft paper

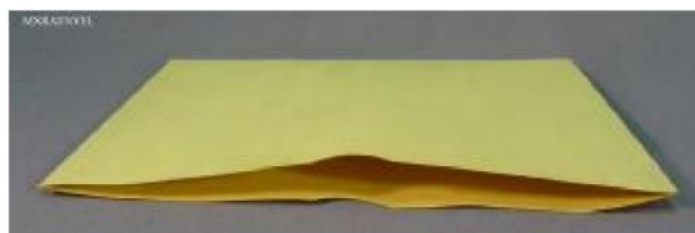

1218 ERASER dual ink/pencil

1219 ERLLENMEYER, GLASS, 500 ml, narrow neck

Used for preparation of reagents and stains
Graduated
Packaging: protective bubble foil

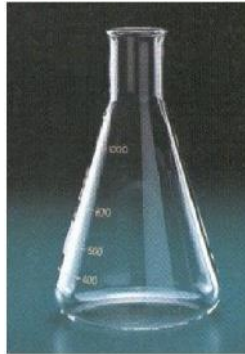

1220 EXTENSION CABLE, 10m, 3x2,5 mm², triple connector

Heavy duty extension cable
H07RNF 3G2,5
Length: 10m
Plug: solid rubber, CEE 7/4 (Type F, Schuko), IP44
Connector: triple connector solid rubber, CEE 7/4 (Type F, Schuko), IP44



1224 EXTERNAL FIXATOR, set for 2 femurs and 3 tibias incl. instruments

Like External Fixation Set by:
Rijcken Fixator Project Foundation, Breda, The Netherlands
To be used with: DRILL, electric, bone surgery

Set for 2 femurs contains:
- 1x T-Wrench/ Pin Driver, Hoffmann II, 7mm/ 5,6mm
- 1x quare Spanner Wrench, Hoffmann II, 7mm

- 2x Removable Thumbwheel, Hoffmann II, 7/5mm
- 1x Drill Brace Assembly Apex
- 2x Predrilling Assembly Short Apex Ø 5mm
- 2x Predrilling Assembly Long Apex Ø6mm
- 1x Handle for Guide Block Apex
- 1x Guide Block for Predrilling Assembly Apex for Hoffmann II 5 Hole Clamp
- 1x Quick Release Chuck Apex for Ø 5mm Pins
- 1x Quick Release Chuck Apex for Ø 6mm Pins
- 2x 5 Hole Pin Clamp, Hoffmann II, 4-6mm
- 4x Rod to Rod Coupling, Hoffmann II MRI, 8/8mm
- 4x Pin to Rod Coupling, Hoffmann II MRI, 4-5/8mm
- 4x 30°Angeld Post, Hoffmann II MRI
- 2x Connecting Rod, Hoffmann II MRI, Ø 8mm x 300mm
- 2x Connecting Rod, Hoffmann II MRI, Ø 8mm x 350mm
- 4x Selfdrilling Half Pin Apex Ø 5mm, 150mm
- 4x Selfdrilling Half Pin Apex Ø 5mm, 180mm
- 4x Selfdrilling Half Pin Apex Ø 6mm, 180mm
- 4x Selfdrilling Half Pin Apex Ø 6mm, 200mm
- Disposable end cups

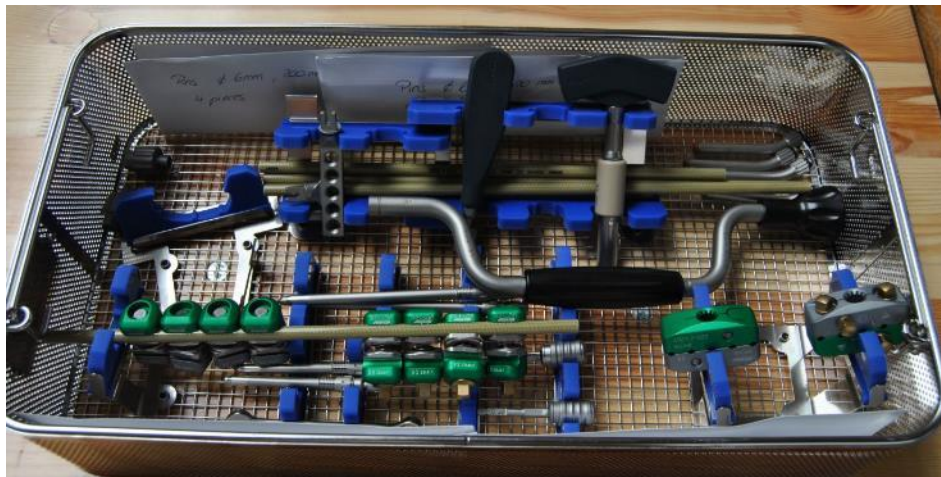

Set for 3 tibias contains:

- 1x T-Wrench/ Pin Driver, Hoffmann II, 7mm/ 5,6mm
- 1x square Spanner Wrench, Hoffmann II, 7mm
- 2x Removable Thumbwheel, Hoffmann II, 7/5mm
- 1x Drill Brace Assembly Apex
- 2x Predrilling Assembly Short Apex Ø 5mm
- 2x Predrilling Assembly Long Apex Ø6mm
- 1x Handle for Guide Block Apex
- 1x Guide Block for Predrilling Assembly Apex for Hoffmann II 5 Hole Clamp
- 1x Quick Release Chuck Apex for Ø 5mm Pins
- 1x Quick Release Chuck Apex for Ø 6mm Pins
- 2x 5 Hole Pin Clamp, Hoffmann II, 4-6mm
- 4x Rod to Rod Coupling, Hoffmann II MRI, 8/8mm
- 4x Pin to Rod Coupling, Hoffmann II MRI, 4-5/8mm
- 4x 30°Angeld Post, Hoffmann II MRI
- 2x Connecting Rod, Hoffmann II MRI, Ø 8mm x 300mm
- 2x Connecting Rod, Hoffmann II MRI, Ø 8mm x 350mm
- 4x Selfdrilling Half Pin Apex Ø 5mm, 150mm
- 4x Selfdrilling Half Pin Apex Ø 5mm, 180mm
- Disposable end cups



1225 EYE SHIELD

For single eye
Clear, vented Polycarbonate
No foam
With elastic adjustable head band



1226 FACE MASK, PROTECTION, FFP3 with exhaler, disposable

Respiratory protection against fine dusts, oil mists, water-based mists, metal fumes, bacteria and virus infection
Lightweight and soft hypo allergenic faceplate
Cool-flow valve (exhaler) reduces heat build-up to offer comfortable protection, particularly in hot and humid conditions
Even-tensioned straps relieve pressure for a comfortable and secure fit



1227 **FIELD BED, foldable, aluminium frame**

Material:

- Frame: aluminum pipe
- Fabric: polyester with PVC coating or polyamide

Open size: approx. L 200 x W 80 x H 45 cm

Packing size: approx. L 95 x W 20 x H 12 cm

Foldable in width and length

Weight: 7,0 kg

Minimum carrying capacity: 120 kg



1228 **FILTER KATADYN, for indoor, drip type, incl. 3 filter elements**

Gravity filter to eliminate bacteria, protozoa, cysts, algae, spores, sediments and viruses in combination with particles greater than 0,2 microns

Like Katadyn TRK Drip Gravidyn

Reduces radioactive particles

Reduction of chemicals by activated carbon

For 1-6 people and long-term use

Cleanable ceramic filter element with activated carbon granules

No movable parts
Measuring gauge indicates when the filter element should be changed
Technology: ceramic depth filtration
Output: Approx. 4 l/hour
Capacity: up to 150'000 litres quality water / 6 months
Weight: approx. 3,3 kg
Size: approx. 25 x 45 cm
Materials: silicone, ceramic, activated carbon
To be used with: (filter Katadyn, indoor, drip type) CERAMIC BONDED ELEMENT



1229 FILTER, HME + anti-bact.-vir. 99.9%, conn. 22/15mm, disp.

Components:

- Rigid Filter housing with two ports designed to accept 15 mm and 22 mm size tubing and connection
- Filter
- Sampling port to measure gas/agents concentration positioned on the anaesthetic breathing system side

Hydrophobic filters: folded ceramic elements

Filter with small pore size membrane providing adequate filtration over longer period of time

The filter relies on natural occurring electrostatic interactions to remove particles

The filter repel water even under high pressures (up to 60cmH₂O)

Bacterial (BFE) and viral (VFE) filtration efficiency of 99.99 %

Moisture and Temperature output (EN 9360):

- | | after 2 hours | after 24 hours | |
|--------------|-------------------------------------|------------------------------------|--|
| - Vt 250ml: | 31.4 mg H ₂ O/l @ 31° | 31.3 mg H ₂ O/l @ 31.0° | |
| - Vt 500ml: | 30.6 mg H ₂ O/l @ 30.9° | 30.7 mg H ₂ O/l @ 31.2° | |
| - Vt 750ml: | 30.1 mg H ₂ O/l @ 30.6° | 30.2 mg H ₂ O/l @ 31.4° | |
| - Vt 1000ml: | 29.3 mg H ₂ O/l @ 30.29° | 29.2 mg H ₂ O/l @ 30.1° | |

Resistance to Flow (EN 9360) after 24 hours_

- - 30 l/min 0.8 cm H₂O
- - 60 l/min 1.9 cm H₂O
- - 90 l/min 3.4 cm H₂O

Dead space (compressible volume): 45 ml

Recommended Tidal Volume Range for Adult >150 ml

Gas Leakage @ 70 hPa (cm H₂O) <1 ml.min.1

Dry Weight 29g-30 g

Initial sterilisation: Ethylene oxide (EO)

Packaging: Individual sterilized peel-packs made of paper and/or plastic

Each peel-pack to be clearly marked with expiry date and batch number

Other requirements: Should conform EN 9360-1

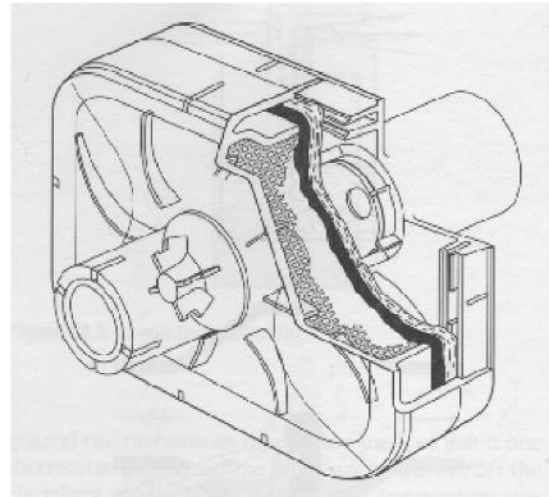
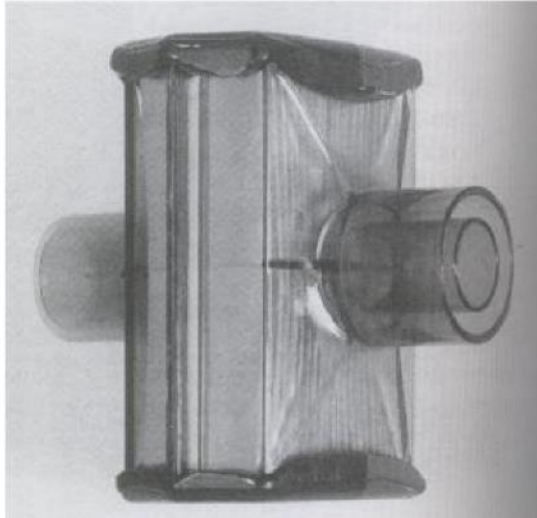

1230 FILTER, PAPER, ROUND, 150 mm, single-ply

Filter paper is used for a superficial filtration of stains

Material: cellulose

Weight: 87g/m²

Retention: 11 µm

Thickness: 0.18mm

Load of ashes: 0.06%

Colour: white

1231 FIXER, powder, for 22.5 litres

Concentrated fixer in powder form for dilution to make 22.5 l of working solution

Storage:

- once prepared, the fixer solution should be used within the 2 coming months and kept between 15° C and 18° C

- protected from sunlight and air to avoid oxidation

Packaging:

- sealed plastic bag to protect from humidity

- product is corrosive for air transport, packing should be in accordance with IATA rules

Labeling:

- clear and explicit instructions should appear on the label

- marked with lot number and expiry date

To be used with: DEVELOPING UNIT, X-RAY, manual, w/ 4 basins, + accessories

DEVELOPING UNIT, X-RAY, automatic

BUCKET, 23 to 26 litres, with lid

1232 FOIL to close tubes

Self-sealing wrapping film for laboratory use, ideal for protecting and sealing cultures, tubes, beakers etc

Like 'Parafilm® M'
Foil should be flexible, moisture resistant
Can be stretched up to 200% its original length before breaking
Has unique permeability properties, impressive water vapor transport properties and is resistant to many common reagents
Unit: roll, approx 75 m length, 5 cm width, 127 micrometer thickness

1233 FOLDER, plastic, DIN A 3, patient record support

Storage folder for patient documentation to be kept at the bedside
Material: polypropylene
Thickness: min 200 µ



1236 FORCEPS, CATH. INTRODUCING, MAGILL, 16cm, child extra small

1237 FORCEPS, CATH. INTRODUCING, MAGILL, 19cm, child small

1238 FORCEPS, CATH. INTRODUCING, MAGILL, 24cm, adult

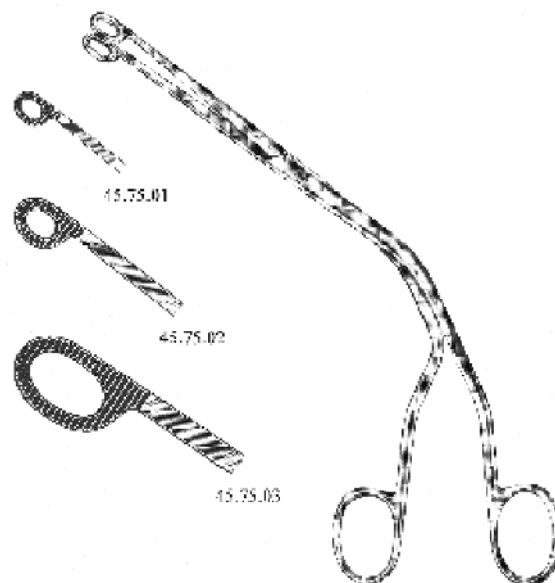

1239 FORCEPS, MICROSCOPE SLIDE

REF. DESCRIPTOR
Specification

Used to handle slides during staining procedures
Material: stainless steel
Length: 105 mm

1240 FORCEPS, OBSTETRICAL, WRIGLEY, 28 cm

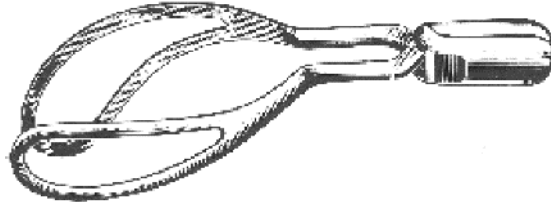

1241 FRAME FOR WASTE BAG

Material: metal
With lid

To be used with: BAG, PE plastic, for garbage, 60 L, black, 0.02mm



1242 FUNNEL, PLASTIC, diam 150 mm

Used to decant reagents with filter paper
Material: plastic, chemical and temperature resistant (up to 100°C)
Diameter 150 mm

1243 FUNNEL, GLASS, diam. 100 mm

Used to filter staining solutions
Packaging: protective bubble foil



1244 FUNNEL, PLASTIC, diam 100 mm

Used to decant reagents with filter paper
Material: plastic, chemical and temperature resistant (up to 100°C)
Diameter: 100 mm



1245 GAUZE, 100x0.9m, 20 threads, for compresses, roll

Material: 100 % hydrophilic cotton medical grade, bleached, purified textile, plain weave
Type of gauze: 20 threads/cm² or 52 threads by square inch
Thread count in cm² / square inch

- Warp: 11 thread /cm²; 28 thread/square inch
- Weft: 9 thread /cm²; 24 thread/square inch

Weight: minimum 27g/m²

With selvedge to avoid the gauze to fray

Non-detectable by X-ray

None sterile

Packaging: individually presented in suitable protective

The following information must appear on the label of each roll:

- Length and width
- material
- type of gauze
- non-sterile

Other requirements: meets Pharmacopoeia specifications: BP, USP; EUR II 95

Conform to ISO 9002

Medical device dir 93/42/CE class 1 EN 868 (1 to7) and EN-10993-10 for Biologic evaluation

1246 GLASSES, PROTECTIVE, plastic

Security glasses, used to protect the eyes during medical and surgical procedure or in a laboratory

Material: Polycarbonate

Standard model

Anti-mist lateral ventilation

Panoramic lenses with nasal ridge

Clear lens

UV filter

Reusable (cleaning with water and detergent)

Packaging: unit packaging



1247 GLOVE, EXAMINATION, LATEX, none sterile, large (8-9)

Ambidextrous powdered glove composed of 5 fingers, a palm and a sleeve

Material: natural latex

Powder: resorbable maize starch

Fits either hand

Total length: 240mm minimum

Width: Large: 110 ± 10mm

Strength:

- Force at break before accelerated ageing: 7.5 N

- After accelerated ageing: 5.5 N

Low residual protein level (see also EN 455-3)

250 µg/g for powdered gloves

Lengthening at break: minimum 600%

Cuff length: minimum 5cm

Strictly for single use, do not sterilize

After use, ensure effective destruction of them by incineration, in a protected area

Storage: in a dry place, away from direct heat source

Packaging: cardboard distribution box of 100 gloves

Labeling on the box: size, date of manufacture and expiry date

Other requirements: meets the European norms EN 455 (1-2) and if possible EN 455-3

Following the European Norm EN 455-3:

- Gloves that are directly derived from latex need to wear the following mention: "(product) containing natural rubber latex likely to provoke allergic reactions"

- Powdered gloves need to wear a label specifying that they are powdered

1248 GLOVE, EXAMINATION, LATEX, none sterile, medium (7-8)

Ambidextrous powdered glove composed of 5 fingers, a palm and a sleeve

Material: natural latex

Powder: resorbable maize starch

Fits either hand

Total length: 240mm minimum
Width: medium: 95 ± 10mm
Strength:
- Force at break before accelerated ageing: 7.5 N
- After accelerated ageing: 5.5 N
Low residual protein level (see also EN 455-3)
250 µg/g for powdered gloves
Lengthening at break: minimum 600%
Cuff length: minimum 5cm
Strictly for single use, do not sterilize
After use, ensure effective destruction of them by incineration, in a protected area
Storage: in a dry place, away from direct heat source
Packaging: cardboard distribution box of 100 gloves
Labeling on the box: size, date of manufacture and expiry date
Other requirements: meets the European norms EN 455 (1-2) and if possible EN 455-3
Following the European Norm EN 455-3:
- Gloves that are directly derived from latex need to wear the following mention: "(product) containing natural rubber latex likely to provoke allergic reactions"
- Powdered gloves need to wear a label specifying that they are powdered

1249 GLOVE, EXAMINATION, LATEX, none sterile, small (6-7)

Ambidextrous powdered glove composed of 5 fingers, a palm and a sleeve
Material: natural latex
Powder: resorbable maize starch
Fits either hand
Total length: 240mm minimum
Width: small: 80 ± 10mm
Strength:
- Force at break before accelerated ageing: 7.5 N
- After accelerated ageing: 5.5 N
Low residual protein level (see also EN 455-3)
250 µg/g for powdered gloves
Lengthening at break: minimum 600%
Cuff length: minimum 5cm
Strictly for single use, do not sterilize
After use, ensure effective destruction of them by incineration, in a protected area
Storage: in a dry place, away from direct heat source
Packaging: cardboard distribution box of 100 gloves
Labeling on the box: size, date of manufacture and expiry date
Other requirements: meets the European norms EN 455 (1-2) and if possible EN 455-3
Following the European Norm EN 455-3:
- Gloves that are directly derived from latex need to wear the following mention: "(product) containing natural rubber latex likely to provoke allergic reactions"
- Powdered gloves need to wear a label specifying that they are powdered

1250 GLOVE, heat protection, isothermal, pair, size 10

To be used for unloading sterilizer

1251 GLOVE, HOUSEHOLD, latex, cotton lining, size L

Pair of gloves used for handling and cleaning soiled objects or surfaces

Material: natural latex outside, cotton inside
Anatomical gloves, partially covering the forearm
Watertight, airtight
Reusable
Thickness: 0,6 mm minimum
Total length: approx. 32 cm
Hand and fingers with non-slip internal side
Size L (8-8,5) palm width: approx. 110 mm
Packaging: unit packaging (per pair)

1252 GLOVE, HOUSEHOLD, latex, cotton lining, size M

Pair of gloves used for handling and cleaning soiled objects or surfaces
Material: natural latex outside, cotton inside
Anatomical gloves, partially covering the forearm
Watertight, airtight
Reusable
Thickness: 0,6 mm minimum
Total length: approx. 32 cm
Hand and fingers with non-slip internal side
Size M (7-7,5) palm width: approx. 95 mm
Packaging: unit packaging (per pair)

1253 GLOVE, HOUSEHOLD, latex, cotton lining, size S

Pair of gloves used for handling and cleaning soiled objects or surfaces
Pair of gloves used for handling and cleaning soiled objects or surfaces
Material: natural latex outside, cotton inside
Anatomical gloves, partially covering the forearm
Watertight, airtight
Reusable
Thickness: 0,6 mm minimum
Total length: approx. 32 cm
Hand and fingers with non-slip internal side
Size S (6-6,5) palm width: approx. 80 mm
Packaging: unit packaging (per pair)

1254 GLOVE, OBSTETRICAL, size 7, elbow length, sterile, pair

Sterile, disposable, anatomically shaped medical gloves with the thumb positioned towards the palmer surface of the index finger rather than laying flat and intended for use in obstetrics/gynaecology for medical procedure, 1 right-handed, 1 left-handed
Material: Latex
Powder: maize starch
Physical property:
- Waterproof
- Stretch proof
Minimum force at break for surgical gloves:
- before accelerated ageing 10.5N
- after accelerated ageing 7.5N
Straight sleeved with reinforced hem (rolled or ending in a reinforced band)
Moulded fabrication
Suppleness: closely fits the morphology of the hand and minimally impairs the wearer's

sense of touch

Shape of the glove faithfully accommodates the anatomy of the hand, the thumb offset from the palm and set forward of the index finger

Slightly powdered: the interior surfaces of the gloves must be finely coated with powder for easy wearing

Low residual protein level (EN 455-3)

Recommended wall thickness:

- Finger area 0.38 mm
- Centre palm area: 0.24 - 0.30 mm / 25 mm
- From cuff end: 0.26 mm

Size 6.5:

- Minimum length 500 mm
- Width 83 +/- 5 mm

Sterilization : Ethylene Oxide or gamma

Packaging:

- One (1) pair of obstetrical gloves in an individual sterilised peel pack
- Gloves must be supplied with double packaging: one interior layer plus sterilised peel-pack
- Gloves must be packed in the interior layer: right and left hand with the sleeves reversed up to the thumb
- Labeled with: size, right hand, left hand and position of the sleeves
- 50 units (pairs of surgical gloves in peel pack) in protective carton box

Labeling:

Peel pack and box should mention: name and/or trademark of the manufacturer, sterile, lot number, expiry date by year and month, "for single use". CE + number, product description

Extra information required: number of units per secondary packaging

Other requirements: conforms to European Norm EN 455 (Parts 1, 2 and 3)



1255 GLOVE, OBSTETRICAL, size 8, elbow length, sterile, pair

Sterile, disposable, anatomically shaped medical gloves with the thumb positioned towards the palmer surface of the index finger rather than laying flat and intended for use in obstetrics/gynaecology for medical procedure, 1 right-handed, 1 left-handed

Material: Latex

Powder: maize starch

Physical property:

- Waterproof
- Stretch proof

Minimum force at break for surgical gloves:

- before accelerated ageing 10.5N
- after accelerated ageing 7.5N

Straight sleeved with reinforced hem (rolled or ending in a reinforced band)

Moulded fabrication

Suppleness: closely fits the morphology of the hand and minimally impairs the wearer's sense of touch

Shape of the glove faithfully accommodates the anatomy of the hand, the thumb offset from the palm and set forward of the index finger

Slightly powdered: the interior surfaces of the gloves must be finely coated with powder for easy wearing

Low residual protein level (EN 455-3)

Recommended wall thickness:

- Finger area 0.38 mm
- Centre palm area: 0.24 - 0.30 mm / 25 mm
- From cuff end: 0.26 mm

Size 6.5:

- Minimum length 500 mm
- Width 83 +/- 5 mm

Sterilization : Ethylene Oxide or gamma

Packaging:

- One (1) pair of obstetrical gloves in an individual sterilised peel pack
- Gloves must be supplied with double packaging: one interior layer plus sterilised peel-pack
- Gloves must be packed in the interior layer: right and left hand with the sleeves reversed up to the thumb
- Labeled with: size, right hand, left hand and position of the sleeves
- 50 units (pairs of surgical gloves in peel pack) in protective carton box

Labeling:

Peel pack and box should mention: name and/or trademark of the manufacturer, sterile, lot number, expiry date by year and month, "for single use". CE + number, product description

Extra information required: number of units per secondary packaging

Other requirements: conforms to European Norm EN 455 (Parts 1, 2 and 3)

1256 GLOVE, PE female

To be used for domestic purpose

Material: PE transparent

Without powder

Female universal size

Non sterile

Disposable

1257 GLOVE, PE Male

To be used for domestic purpose

Material: PE transparent

Without powder

Male universal size

Non sterile

Disposable

1258 GLOVE, SURGICAL, latex-free, size 6.5, sterile, pair

One pair of slightly powdered gloves: 1 right-handed, 1 left-handed

Material: latex-free

Powder: maize starch

Physical property:

- Waterproof
- Stretch proof

Minimum force at break for surgical gloves:

- before accelerated ageing 10.5N
- after accelerated ageing 7.5N

Straight sleeved with reinforced hem (rolled or ending in a reinforced band)

Moulded fabrication

Suppleness: closely fits the morphology of the hand and minimally impairs the wearer's sense of touch

Shape of the glove faithfully accommodates the anatomy of the hand, the thumb offset from the palm and set forward of the index finger

Slightly powdered: the interior surfaces of the gloves must be finely coated with powder for easy wearing

Low residual protein level (EN 455-3)

Recommended wall thickness:

- Finger area 0.38 mm
- Centre palm area: 0.24 - 0.30 mm / 25 mm
- From cuff end: 0.26 mm

Size: minimum dimensions recommended for surgical gloves size 6.5:

- Length: 270 mm
- Width: 83 ± 5 mm

The surgical glove cuff should have a sufficient length to cover adequately the surgeon/nurse wrist when wearing operating theatre gown

Initial sterilisation method: Ethylene oxide gas

Packaging:

- One (1) pair of surgical gloves in an individual sterilised peel pack
- Gloves must be supplied with double packaging: one interior layer plus sterilised peel-pack
- Gloves must be packed in the interior layer: right and left hand with the sleeves reversed up to the thumb
- Labeled with: size, right hand, left hand and position of the sleeves
- 50 units (pairs of surgical gloves in peel pack) in protective carton box

Labeling:

Peel pack and box should mention: name and/or trademark of the manufacturer, sterile, lot number, expiry date by year and month, "for single use". CE + number, product description

Extra information required: number of units per secondary packaging

Other requirements: conforms to European Norm EN 455 (Parts 1, 2 and 3)

1259 GLOVE, SURGICAL, latex-free, size 7, sterile, pair

One pair of slightly powdered gloves: 1 right-handed, 1 left-handed

Material: latex-free

Powder: maize starch

Physical property:

- Waterproof
- Stretch proof

Minimum force at break for surgical gloves:

- before accelerated ageing 10.5N
- after accelerated ageing 7.5N

Straight sleeved with reinforced hem (rolled or ending in a reinforced band)

Moulded fabrication

Suppleness: closely fits the morphology of the hand and minimally impairs the wearer's sense of touch

Shape of the glove faithfully accommodates the anatomy of the hand, the thumb offset from the palm and set forward of the index finger

Slightly powdered: the interior surfaces of the gloves must be finely coated with powder for easy wearing

Low residual protein level (EN 455-3)

Recommended wall thickness:

- Finger area 0.38 mm

- Centre palm area: 0.24 - 0.30 mm / 25 mm
 - From cuff end: 0.26 mm
- Size: minimum dimensions recommended for surgical gloves size 7:
Length: 280 mm
Width: 89 ± 5 mm
- The surgical glove cuff should have a sufficient length to cover adequately the surgeon/nurse wrist when wearing operating theatre gown
- Initial sterilisation method: Ethylene oxide gas
- Packaging:
- One (1) pair of surgical gloves in an individual sterilised peel pack
 - Gloves must be supplied with double packaging: one interior layer plus sterilised peel-pack
 - Gloves must be packed in the interior layer: right and left hand with the sleeves reversed up to the thumb
 - Labeled with: size, right hand, left hand and position of the sleeves
 - 50 units (pairs of surgical gloves in peel pack) in protective carton box
- Labeling:
Peel pack and box should mention: name and/or trademark of the manufacturer, sterile, lot number, expiry date by year and month, "for single use". CE + number, product description
- Extra information required: number of units per secondary packaging
- Other requirements:** conforms to European Norm EN 455 (Parts 1, 2 and 3)

1260 GLOVE, SURGICAL, latex-free, size 7.5, sterile, pair

- One pair of slightly powdered gloves: 1 right-handed, 1 left-handed
- Material: latex-free
- Powder: maize starch
- Physical property:
- Waterproof
 - Stretch proof
- Minimum force at break for surgical gloves:
- before accelerated ageing 10.5N
 - after accelerated ageing 7.5N
- Straight sleeved with reinforced hem (rolled or ending in a reinforced band)
- Moulded fabrication
- Suppleness: closely fits the morphology of the hand and minimally impairs the wearer's sense of touch
- Shape of the glove faithfully accommodates the anatomy of the hand, the thumb offset from the palm and set forward of the index finger
- Slightly powdered: the interior surfaces of the gloves must be finely coated with powder for easy wearing
- Low residual protein level (EN 455-3)
- Recommended wall thickness:
- Finger area 0.38 mm
 - Centre palm area: 0.24 - 0.30 mm / 25 mm
 - From cuff end: 0.26 mm
- Size: minimum dimensions recommended for surgical gloves size 7.5:
Length: 280 mm
Width: 85 ± 5 mm
- The surgical glove cuff should have a sufficient length to cover adequately the surgeon/nurse wrist when wearing operating theatre gown
- Initial sterilisation method: Ethylene oxide gas
- Packaging:
- One (1) pair of surgical gloves in an individual sterilised peel pack
 - Gloves must be supplied with double packaging: one interior layer plus sterilised peel-pack
 - Gloves must be packed in the interior layer: right and left hand with the sleeves reversed up to the thumb

- Labeled with: size, right hand, left hand and position of the sleeves
- 50 units (pairs of surgical gloves in peel pack) in protective carton box

Labeling:

Peel pack and box should mention: name and/or trademark of the manufacturer, sterile, lot number, expiry date by year and month, "for single use". CE + number, product description

Extra information required: number of units per secondary packaging

Other requirements: conforms to European Norm EN 455 (Parts 1, 2 and 3)

1261 GLOVE, SURGICAL, latex-free, size 8.5, sterile, pair

One pair of slightly powdered gloves: 1 right-handed, 1 left-handed

Material: latex-free

Powder: maize starch

Physical property:

- Waterproof
- Stretch proof

Minimum force at break for surgical gloves:

- before accelerated ageing 10.5N
- after accelerated ageing 7.5N

Straight sleeved with reinforced hem (rolled or ending in a reinforced band)

Moulded fabrication

Suppleness: closely fits the morphology of the hand and minimally impairs the wearer's sense of touch

Shape of the glove faithfully accommodates the anatomy of the hand, the thumb offset from the palm and set forward of the index finger

Slightly powdered: the interior surfaces of the gloves must be finely coated with powder for easy wearing

Low residual protein level (EN 455-3)

Recommended wall thickness:

- Finger area 0.38 mm
- Centre palm area: 0.24 - 0.30 mm / 25 mm
- From cuff end: 0.26 mm

Size: minimum dimensions recommended for surgical gloves size 8:

Length: 290 mm

Width: 102 ± 6 mm

The surgical glove cuff should have a sufficient length to cover adequately the surgeon/nurse wrist when wearing operating theatre gown

Initial sterilisation method: Ethylene oxide gas

Packaging:

- One (1) pair of surgical gloves in an individual sterilised peel pack
- Gloves must be supplied with double packaging: one interior layer plus sterilised peel-pack
- Gloves must be packed in the interior layer: right and left hand with the sleeves reversed up to the thumb
- Labeled with: size, right hand, left hand and position of the sleeves
- 50 units (pairs of surgical gloves in peel pack) in protective carton box

Labeling:

Peel pack and box should mention: name and/or trademark of the manufacturer, sterile, lot number, expiry date by year and month, "for single use". CE + number, product description

Extra information required: number of units per secondary packaging

Other requirements: conforms to European Norm EN 455 (Parts 1, 2 and 3)

1262 GLUCOMETER, battery operated

Used to determine and monitor blood glucose level

Like "ACCU CHEK Avivia", or One TOUCH

Material: plastic case
Operation in very humid conditions possible
Blood glucose test strip storage conditions also possible in high temperatures
Battery operated
Measurement unit: mg/dl or mmol/l
Measurement range: 10 - 600 mg/dl
Packaging: individually packed as complete set

To be supplied with:

Glucometer in etui
10 test strips and code strip
Automatic lancet
100 needle lancets
1 Battery

To be used with: BLOOD SUGAR CONTROL SERUM, bottle
BLOOD SUGAR TEST STRIP (according to the company of the glucometer)

1263 GOGGLES, PROTECTIVE, plastic

Safety Goggles, close fit
Deep, curved PVC frame, close fit and versatility to wear over prescription glasses
Clear polycarbonate lenses for protection from impact, droplets and splashes, large dust particles and molten metal and hot solids
Indirect ventilation
Chemicals resistant
Weight: approx. 110 g
According to DIN EN 166



f

1264 GOWN, SURGICAL, reusable, cotton, size L

Preferably gown with raglan sleeves, non-deforming arm cuffs in jersey (12 cm) with braided thumb loop
Back closing with 2 or 3 braids + covering back panel with braided side fastening (orthopaedic type gown)
Colour: blue or green
Size L:
- Length 128 cm
- Chest measurement: 102-105 cm
- Hip measurement: 108-110 cm
Washing: normal, withstands boiling and autoclaving, resists to chlorine 0.5%
Packaging: protected in a plastic bag, single or multiple unit



1265 GOWN, SURGICAL, reusable, cotton, size M

Preferably gown with raglan sleeves, non-deforming arm cuffs in jersey (12 cm) with braided thumb loop

Back closing with 2 or 3 braids + covering back panel with braided side fastening (orthopaedic type gown)

Colour: blue or green

Size M:

- Length 127 cm
- Chest measurement: 102-105 cm
- Hip measurement: 93-97 cm

Washing: normal, withstands boiling and autoclaving, resists to chlorine 0.5%

Packaging: protected in a plastic bag, single or multiple unit

1266 GOWN, SURGICAL, reusable, cotton, size XL

Preferably gown with raglan sleeves, non-deforming arm cuffs in jersey (12 cm) with braided thumb loop

Back closing with 2 or 3 braids + covering back panel with braided side fastening (orthopaedic type gown)

Colour: blue or green

Size XL:

- Length 140 cm
- Chest measurement: 117-122 cm
- Hip measurement: 125-132 cm

Washing: normal, withstands boiling and autoclaving, resists to chlorine 0.5%

Packaging: protected in a plastic bag, single or multiple unit

1267 GOWN, SURGICAL, size M, disposable, sterile

Reinforced gowns include reinforcements, or double layers of fabric, in both the sleeve and chest areas, foreseen for medium OP and medium water flow

Material: none woven fabric from spun laced polyester-pulp, polypropylene, or viscose/SMS

Color: green or blue

Design type:

- With raglan sleeves
- Non-deforming jersey cuffs (12 cm)
- Back closing + covering back panel with braided side fastening
- Adjustable neckline (orthopaedic type)

Length 120 cm

Packaging and labeling: each gown in sterile peel pack, should mention exp date, lot number, items description, size, type of sterilization, manufacturer name, ref number, CE + Nr, protective carton packing with same information and no. of units



1268 GOWN, SURGICAL, size XL, disposable, sterile

Reinforced gowns include reinforcements, or double layers of fabric, in both the sleeve and chest areas, foreseen for medium OP and medium water flow

Material: none woven fabric from spun laced polyester-pulp, polypropylene, or viscose/SMS

Color: green or blue

Design type:

- With raglan sleeves
- Non-deforming jersey cuffs (12 cm)
- Back closing + covering back panel with braided side fastening
- Adjustable neckline (orthopaedic type)

Length 150 cm

Packaging and labeling: each gown in sterile peel pack, should mention exp date, lot number, items description, size, type of sterilization, manufacturer name, ref number, CE + Nr, protective carton packing with same information and no. of units

1269 HAEMOGLOBINOMETER like "HEMOCUE201+", with transformer

Used to determine haemoglobin

Material: plastic case

Transformer or battery operated

Easy to handle and maintain

To be used with: MICROCUVETTES and CLEANER SWABS (according to the company of the haemoglobinometer)



1270 HAEMOGLOBINOMETER, SAHLI, set

Used to measure haemoglobin by comparison of the patient's blood tube with the glass standard of the Sahli haemometer

Components:

- 1 Haemoglobinometer set, Sahli type, complete with two non fading plain precision standards in plastic housing
- 1 Sahli pipette
- 1 Round measuring tube, scaled 10-140% in 1% steps on one face and 2 to 22g heamoglobin in 0.2 g steps on the opposite face
- 1 Glass stirring rod
- 1 15 ml glass bottle in plastic case with screw cap
- 1 Cleaning brush for tube

Complete in plastic case

Accuracy +/- 0,5 g%

To be used with: (haemoglobinometer, Sahli), PIPETTE, GLASS, SAHLI, 20µl
(haemoglobinometer, Sahli), ROD STIRRING, GLASS, SAHLI
(haemoglobinometer, Sahli), TUBE, GRADUATED, GLASS, SAHLI



1271 HAMMER, PERCUSSION, 20 cm

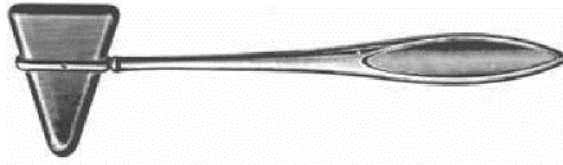

1272 HANGER, for X-ray films 24 x 30 cm

For tank development of X-ray film

Material: stainless steel

Stainless steel frame has attached clips to hold film taut

For film size 24 x 30 cm

To be used with: DEVELOPING UNIT, X-RAY, manual, w/ 4 basins, + accessories



1273 HANGER, for X-ray films 30 x 40 cm

For tank development of X-ray film

Material: stainless steel

Stainless steel frame has attached clips to hold film taut

For film size 30 x 40 cm

To be used with: DEVELOPING UNIT, X-RAY, manual, w/ 4 basins, + accessories

1274 HANGER, for X-ray films 35 x 43 cm

For tank development of X-ray film

Material: stainless steel

Stainless steel frame has attached clips to hold film taut

For film size 35 x 43 cm

To be used with: DEVELOPING UNIT, X-RAY, manual, w/ 4 basins, + accessories

1275 HEALTH CHART (WHO standard)

Designed according to WHO standard
DIN A 4 format
Material: paper for heavy duty use

1276 HEALTH CHART, children

Designed according to WHO standard
DIN A 4 format
Paper for heavy duty use

1277 HEEL, for PoP, for adult

For correct walking when leg is in Plaster of Paris
To protect against dirt and wetness
Material: synthetic rubber to absorb walking shocks
With mounting link strap for immediate or later application
Lower part with walking profile
Size: adults
e.g. from Lohmann and Rauscher

1278 HEEL, for PoP, for child

For correct walking when leg is in Plaster of Paris
To protect against dirt and wetness
Material: synthetic rubber to absorb walking shocks
With mounting link strap for immediate or later application
Lower part with walking profile
Size: child
e.g. from Lohmann and Rauscher

1280 HOLDER, for test tubes, wood, "Lipowitz type"

Holder used for handling test and centrifuge tubes
Mainly used to hold the tubes above spirit lamp or burner
Material: wood
Length: 250 mm
Opening of the holder for tubes up to 18 mm diam.

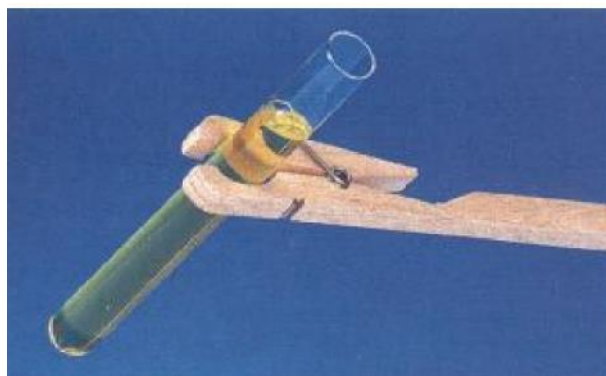

1281 HOOK, s-shape, stainless steel

Size: approx. 12 cm x 4 cm

No spike ends, but do not have to be rounded like in example



1282 HOSPITAL BED, with backrest, with wheels

Length patient area: approx 200 cm

Max. weight-loading: 200 kg

Knock-down construction

Lightweight and sturdy structure

Easy to assemble without tools

Flame retardant

Easy to disinfect

Provides:

- adjustable sturdy back support
- safety bed rails
- rack for patient info folder
- side table
- IV stand/traction support
- bed base layer with double function (can be used as a normal bed or as a cholera cot with opening in the middle section of the bed)

1284 HOURGLASS, for pulse

Hour glass for taking pulse rate inside metal, protective housing

Material:

- Hourglass: glass or plastic
- Outer housing: stainless steel or other strong, protective, non-corrosive material

Time: 15 sec

Can be easily cleaned

1285 HYGIENIC PADS, normal

Women sanitary pads

Length: 22-25 cm

Width: 6-7 cm

Pulp: 7.7 g

Silicone paper: 0.275 g

Tissue paper: 0.65 g

Non woven with adhesive tape
Total weight: 10.8 g +/- 5%
The supplier is to certify that the sanitary pad does not contain any dangerous substances and is fit for human utilisation

1288 INDICATOR, STERILIZATION, chemical

Class 5 integrating indicator strip for steam

- 121 °C for 15 minutes
- 134°C for 4 min

Other requirements: meets ISO 11140

1290 INFUSION SET, min. 150cm, with air intake, inj. site, no needle

Components and material:

Spike/perforator: ABS (Acrylonitrile Butadiene Styrene) or POM (polyacetal)

Air inlet and drop counting chamber: PVC

Tubing: PVC based material

Flow regulator/roller clamp: polystyrene

Injection site: latex or silicone

Spike/perforator:

- Hollow device with a sharp tapering cannulae, situated at the proximal end of the IV set, ensuring safe seal between the IV line and fluid container (bottle or bag)

Air inlet:

- for gravity infusions
- Open air inlet for glass bottle / plastic rigid container closed air inlet for plastic bags /pouch
- Incorporated into the spike/perforator with bacteria proof filter and closable Eurocap system

Drop counting chamber:

- Transparent, supple, compressible bag with calibrated tube (upper end) providing even drops formation: 20 drops = ± 1 ml

- 15-20µ filter (lower end) designed to retain any particle
- Trap for air bubbles and measuring drip flow rate by adjusting the drops

Tube:

- Transparent, allowing bubbles detection, supple, resistant to kinking
- Minimum length: 150cm, giving the IV set an overall length of 170-180cm

Flow regulator/Roller clamp:

- Situated between the drip counting chamber and the connector, allows narrowing the tube lumen, by compressing without damaging the tubing
- Good quality roller clamp enable precise fluid regulation and also permit to stop the drip when needed

Injection site:

- Self-sealing bung
- As close as possible to the IV line's proximal end just before Luer connection
- Allows to inject emergency drugs into the flow without extra dilution

Disposable item, single use, sterile

Packaging and labeling: individual peel-packs made of paper and/or plastic, should mention expiry date, lot number, type of sterilization, manufacturer name, ref number, CE + no, directions of use



1291 INFUSION SET, PAEDIATRIC, with burette, and air intake

Sterile infusion set with graded chamber for a slow intravenous administration of a precise volume of infusion or injectable drug over a given time.

This system limits risk for hypervolemia

It is to be connected between the infusion and the intravenous catheter for paediatric use

Components and materials:

- Tube: PVC
- Plastic perforator: polyacetate
- Air inlet: Acrylonitrile Butadiene Styrene = ABS
- Graduated chamber, 150ml: polystyrene
- Security gauge: natural rubber
- Drop counter: metal
- Infusion filter: polyamide
- Flow regulator: Acrylonitrile Butadiene Styrene = ABS
- Injection portal, at 30cm from the stopper: Acrylonitrile Butadiene Styrene = ABS + synthetic rubber without latex
- Stopper, mobile lock: Methyl Acrylonitrile Butadiene Styrene = MABS

Sterility protector with membrane

Tubing:

- Transparent (allowing the detection of air bubbles), supple, resistant to kinking
± 150cm long (giving the set and overall length of 160-170cm)
- Internal diameter: 3mm
- External diameter: 4mm
- Ended by a Luer lock connector

Perforator/Piercing spike:

- Hollow device situated at the proximal end of the set allowing connection to the fluid bottle or flexible bag
- Composed of a tapering tube, mounted on a base ensuring a good seal between the set and the fluid container

Air inlet:

- bacteriological filter which holds back the micro organisms
- Incorporated into the perforator
- Made up of a tapering tube attached to a waterproof membrane

Graduated chamber:

- Connected to the perforator by a 15cm tube
- Transparent
- Graduations every ml, 150ml

The security gauge stops automatically the infusion as soon as the pre-set volume has flown away in order to prevent air entering the drop-counting chamber and/or the tube

Drop-counting chamber:

- Placed under the chamber
- Drop-counter, calibrated 60 drops/ml
- 15 microns infusion filter

The injection portal allows introducing, via a needle, an injectable drug into infusion flow in the precise volume (e.g. quinine, antibiotics, Mg₂Cl, KCl) needing slow IV administration
Sterile, disposable
Store at temperature below 30°, protected from humidity
Packaging and labeling: in sterile peel-pack, should mention exp date, lot number, items description, type of sterilization method, manufacturer name, ref number, CE + no, directions of use



1292 POLYVIDONE IODINE, 10%, solution, 1L, btl.

Antiseptic and disinfecting
In the WHO 'Essential Medicines' list 2011
To be used undiluted (10%) or diluted (2.5% or 0.5%, i.e. 1+3 or 1 +19 parts water)

1293 SAFETY IV CANNULA, G 14, 2.0 x 50 mm, teflon, with inj. site, orange

Components:

- Catheter hub:
- Fixation wing
- Injection port with closing cone
- Luer lock fitting
- Introducing guide
- Internal needle/ trocar
- Safety needle guard
- Safety shield
- Protective cap
- Handgrip
- Stopper

Hub:

- cannula part which will remain inserted, Fluoroethypropylene (FEP)/ Teflon

Catheter (distal part):

- transparent, straight
- with 2-4 fully embed x-ray contrast lines, tapering end (the x-ray line allows better control over catheter and internal needle when doing a vein puncture in poor light environment)

Injection port:

- With bacterial filter and a removable closing cap/cone with fixed strap
- The cap should be without protuberance

Fixation wing:

- Sloped supporting surface to compensate for puncture gradient

Luer connection (proximal part):

- For attachment of infusion line or, syringe with Luer lock fitting

Introducing guide:

- Will be withdrawn after successful vein puncture

Internal needle/ trocar:

- Stainless steel
- With beveled edge to have good skin penetration and to reduce vein trauma

- The internal needle is connected to a transparent flashback chamber with handgrip and stopper
 - These transparent base allows to watch blood reflux when vein is punctured
- Safety shield:
- Robust safety shield covers entire needle
 - Can be activated with the thumb, finger or any flat surface
 - Needle based engineering control
 - Maximizes protection from sharps injury
- Colour-coded hub and cannula, by size
Recommended brand: Braun, Becton Dickinson
Sterile, disposable
Packaging: individual sterilized peel-packs made of paper and/or plastic in protective carton packaging (25-50 units/box)
Labeling: exp date, lot number, items description multilingual, type of sterilization, manufacturer name, ref number, CE + no, directions of use
- Other requirements:** Quality must comply with Medical Device Directive 93/42/EEC or equivalent
Meets the following standards:
EN-ISO 10555-1: Sterile, single-use intravascular catheters - Part 1: General requirements
EN-ISO 20594-1: Conical fittings with a 6% (Luer) taper for syringes, needles and certain other medical equipment (Part 1: General requirements (ISO 594-1:1986))

1294 SAFETY IV CANNULA, G 16, 1.7 x 50 mm, teflon, with inj. site, grey

Components:

- Catheter hub:
- Fixation wing
- Injection port with closing cone
- Luer lock fitting
- Introducing guide
- Internal needle/ trocard
- Safety needle guard
- Safety shield
- Protective cap
- Handgrip
- Stopper

Hub:

- cannula part which will remain inserted, Fluoroethypropylene (FEP)/ Teflon

Catheter (distal part):

- transparent, straight
- with 2-4 fully embed x-ray contrast lines, tapering end (the x-ray line allows better control over catheter and internal needle when doing a vein puncture in poor light environment)

Injection port:

- With bacterial filter and a removable closing cap/cone with fixed strap
- The cap should be without protuberance

Fixation wing:

- Slopped supporting surface to compensate for puncture gradient

Luer connection (proximal part):

- For attachment of infusion line or, syringe with Luer lock fitting

Introducing guide:

- Will be withdrawn after successful vein puncture

Internal needle/ trocard:

- Stainless steel
- With beveled edge to have good skin penetration and to reduce vein trauma

- The internal needle is connected to a transparent flashback chamber with handgrip and stopper
 - These transparent base allows to watch blood reflux when vein is punctured
- Safety shield:
- Robust safety shield covers entire needle
 - Can be activated with the thumb, finger or any flat surface
 - Needle based engineering control
 - Maximizes protection from sharps injury
- Colour-coded hub and cannula, by size
Recommended brand: Braun, Becton Dickinson
Sterile, disposable
Packaging: individual sterilized peel-packs made of paper and/or plastic in protective carton packaging (25-50 units/box)
Labeling: exp date, lot number, items description multilingual, type of sterilization, manufacturer name, ref number, CE + no, directions of use
- Other requirements:** Quality must comply with Medical Device Directive 93/42/EEC or equivalent
Meets the following standards:
EN-ISO 10555-1: Sterile, single-use intravascular catheters - Part 1: General requirements
EN-ISO 20594-1: Conical fittings with a 6% (Luer) taper for syringes, needles and certain other medical equipment (Part 1: General requirements (ISO 594-1:1986))

1295 SAFETY IV CANNULA, G 18, 1.3 x 45 mm, teflon, with inj. site, green

Components:

- Catheter hub:
- Fixation wing
- Injection port with closing cone
- Luer lock fitting
- Introducing guide
- Internal needle/ trocard
- Safety needle guard
- Safety shield
- Protective cap
- Handgrip
- Stopper

Hub:

- cannula part which will remain inserted, Fluoroethypropylene (FEP)/ Teflon

Catheter (distal part):

- transparent, straight
- with 2-4 fully embed x-ray contrast lines, tapering end (the x-ray line allows better control over catheter and internal needle when doing a vein puncture in poor light environment)

Injection port:

- With bacterial filter and a removable closing cap/cone with fixed strap
- The cap should be without protuberance

Fixation wing:

- Slopped supporting surface to compensate for puncture gradient

Luer connection (proximal part):

- For attachment of infusion line or, syringe with Luer lock fitting

Introducing guide:

- Will be withdrawn after successful vein puncture

Internal needle/ trocard:

- Stainless steel
- With beveled edge to have good skin penetration and to reduce vein trauma

- The internal needle is connected to a transparent flashback chamber with handgrip and stopper
 - These transparent base allows to watch blood reflux when vein is punctured
- Safety shield:
- Robust safety shield covers entire needle
 - Can be activated with the thumb, finger or any flat surface
 - Needle based engineering control
 - Maximizes protection from sharps injury
- Colour-coded hub and cannula, by size
Recommended brand: Braun, Becton Dickinson
Sterile, disposable
Packaging: individual sterilized peel-packs made of paper and/or plastic in protective carton packaging (25-50 units/box)
Labeling: exp date, lot number, items description multilingual, type of sterilization, manufacturer name, ref number, CE + no, directions of use
- Other requirements:** Quality must comply with Medical Device Directive 93/42/EEC or equivalent
Meets the following standards:
EN-ISO 10555-1: Sterile, single-use intravascular catheters - Part 1: General requirements
EN-ISO 20594-1: Conical fittings with a 6% (Luer) taper for syringes, needles and certain other medical equipment (Part 1: General requirements (ISO 594-1:1986))

1296 SAFETY IV CANNULA, G 20, 1.1 x 33 mm, teflon, with inj. site, pink

Components:

- Catheter hub:
- Fixation wing
- Injection port with closing cone
- Luer lock fitting
- Introducing guide
- Internal needle/ trocard
- Safety needle guard
- Safety shield
- Protective cap
- Handgrip
- Stopper

Hub:

- cannula part which will remain inserted, Fluoroethypropylene (FEP)/ Teflon

Catheter (distal part):

- transparent, straight
- with 2-4 fully embed x-ray contrast lines, tapering end (the x-ray line allows better control over catheter and internal needle when doing a vein puncture in poor light environment)

Injection port:

- With bacterial filter and a removable closing cap/cone with fixed strap
- The cap should be without protuberance

Fixation wing:

- Slopped supporting surface to compensate for puncture gradient

Luer connection (proximal part):

- For attachment of infusion line or, syringe with Luer lock fitting

Introducing guide:

- Will be withdrawn after successful vein puncture

Internal needle/ trocard:

- Stainless steel
- With beveled edge to have good skin penetration and to reduce vein trauma

- The internal needle is connected to a transparent flashback chamber with handgrip and stopper
 - These transparent base allows to watch blood reflux when vein is punctured
- Safety shield:
- Robust safety shield covers entire needle
 - Can be activated with the thumb, finger or any flat surface
 - Needle based engineering control
 - Maximizes protection from sharps injury
- Colour-coded hub and cannula, by size
Recommended brand: Braun, Becton Dickinson
Sterile, disposable
Packaging: individual sterilized peel-packs made of paper and/or plastic in protective carton packaging (25-50 units/box)
Labeling: exp date, lot number, items description multilingual, type of sterilization, manufacturer name, ref number, CE + no, directions of use
- Other requirements:** Quality must comply with Medical Device Directive 93/42/EEC or equivalent
Meets the following standards:
EN-ISO 10555-1: Sterile, single-use intravascular catheters - Part 1: General requirements
EN-ISO 20594-1: Conical fittings with a 6% (Luer) taper for syringes, needles and certain other medical equipment (Part 1: General requirements (ISO 594-1:1986))

1297 SAEFTY IV CANNULA, G 22, 0.9 x 25 mm, teflon, with inj. site, blue

Components:

- Catheter hub:
- Fixation wing
- Injection port with closing cone
- Luer lock fitting
- Introducing guide
- Internal needle/ trocard
- Safety needle guard
- Safety shield
- Protective cap
- Handgrip
- Stopper

Hub:

- cannula part which will remain inserted, Fluoroethypropylene (FEP)/ Teflon

Catheter (distal part):

- transparent, straight
- with 2-4 fully embed x-ray contrast lines, tapering end (the x-ray line allows better control over catheter and internal needle when doing a vein puncture in poor light environment)

Injection port:

- With bacterial filter and a removable closing cap/cone with fixed strap
- The cap should be without protuberance

Fixation wing:

- Slopped supporting surface to compensate for puncture gradient

Luer connection (proximal part):

- For attachment of infusion line or, syringe with Luer lock fitting

Introducing guide:

- Will be withdrawn after successful vein puncture

Internal needle/ trocard:

- Stainless steel
- With beveled edge to have good skin penetration and to reduce vein trauma

- The internal needle is connected to a transparent flashback chamber with handgrip and stopper
 - These transparent base allows to watch blood reflux when vein is punctured
- Safety shield:
- Robust safety shield covers entire needle
 - Can be activated with the thumb, finger or any flat surface
 - Needle based engineering control
 - Maximizes protection from sharps injury
- Colour-coded hub and cannula, by size
Recommended brand: Braun, Becton Dickinson
Sterile, disposable
Packaging: individual sterilized peel-packs made of paper and/or plastic in protective carton packaging (25-50 units/box)
Labeling: exp date, lot number, items description multilingual, type of sterilization, manufacturer name, ref number, CE + no, directions of use
- Other requirements:** Quality must comply with Medical Device Directive 93/42/EEC or equivalent
Meets the following standards:
EN-ISO 10555-1: Sterile, single-use intravascular catheters - Part 1: General requirements
EN-ISO 20594-1: Conical fittings with a 6% (Luer) taper for syringes, needles and certain other medical equipment (Part 1: General requirements (ISO 594-1:1986))

1298 SAFETY IV CANNULA, G 24, 0.7 x 19 mm, teflon, with inj. site, yellow

Components:

- Catheter hub:
- Fixation wing
- Injection port with closing cone
- Luer lock fitting
- Introducing guide
- Internal needle/ trocard
- Safety needle guard
- Safety shield/mechanism
- Protective cap
- Handgrip
- Stopper

Hub:

- cannula part which will remain inserted, Fluoroethypropylene (FEP)/ Teflon

Catheter (distal part):

- transparent, straight
- with 2-4 fully embed x-ray contrast lines, tapering end (the x-ray line allows better control over catheter and internal needle when doing a vein puncture in poor light environment)

Injection port:

- With bacterial filter and a removable closing cap/cone with fixed strap
- The cap should be without protuberance

Fixation wing:

- Slopped supporting surface to compensate for puncture gradient

Luer connection (proximal part):

- For attachment of infusion line or, syringe with Luer lock fitting

Introducing guide:

- Will be withdrawn after successful vein puncture

Internal needle/ trocard:

- Stainless steel
- With beveled edge to have good skin penetration and to reduce vein trauma

- The internal needle is connected to a transparent flashback chamber with handgrip and stopper
 - These transparent base allows to watch blood reflux when vein is punctured
- Safety shield/mechanism:
- Robust safety shield or box covers entire needle or needle is retracted
 - Can be activated with the thumb, finger or any flat surface
 - Maximizes protection from sharps injury
- Colour-coded hub and cannula, by size
Recommended brand: Braun, Becton Dickinson
Sterile, disposable
Packaging: individual sterilized peel-packs made of paper and/or plastic in protective carton packaging (25-50 units/box)
Labeling: exp date, lot number, items description multilingual, type of sterilization, manufacturer name, ref number, CE + no, directions of use
Other requirements: Quality must comply with Medical Device Directive 93/42/EEC or equivalent
Meets the following standards:
EN-ISO 10555-1: Sterile, single-use intravascular catheters - Part 1: General requirements
EN-ISO 20594-1: Conical fittings with a 6% (Luer) taper for syringes, needles and certain other medical equipment (Part 1: General requirements (ISO 594-1:1986))

1300 JERRYCAN, foldable, 10L, food grade plastic, screw cap 50mm

Material: new LDPE plastic (low density polyethylene), blow molded
Square shape type, injection molded screw cap with integral tap
Translucent, no colour, UV-stabilized



1301 KETTLE, electrical, 230 V, 2L, plastic, 2000W

Boiling time of approx 3 minutes
Temperature safety cutout, handle to be heatproof, with close fitting lid
Approx 1.5 -2 kW, 230V
To be supplied with: 1.5 m cable and plug (European)

1302 KIDNEY DISH, medium, 250x140x40mm, stainless steel

Kidney shape, non-sterile
Length: 25 cm
Width: 14 cm
Depth: 4 cm



1303 KIT, EMERGENCY, for children, without drugs

Prepacked in a backpack with contents list featuring expiry dates (hard and soft copy)
Completely equipped according to DIN 13232 A+C
Without drugs, without oxygen

Including contents list:

- 1 SUCTION UNIT, hand operated, 600ml
- 1 TUBE SUCTION, CH12, 53cm. straight, sterile, disposable
- 1 TUBE SUCTION, CH14, 53cm. straight, sterile, disposable
- 1 TUBE SUCTION, CH16, 53cm. straight, sterile, disposable
- 1 MUCUS EXTRACTOR, for newborn, CH10, with HIV filter
- 1 RESUSCITATOR, BABY, incl. 1 Paedi valve + 1 mask No OA
- 1 PEEP valve
- 1 BACTERIAL FILTER FOR RESUSCITATOR
- 1 FORCEPS, CATH. INTRODUCING, MAGILL, 16cm, child extra small
- 1 LARYNGOSCOPE, McIntosh, baby, handle diam. 19 mm, blade 0,1,2
- 1 FACE MASK, FOR RESUSCITATOR, size 0A, neonate/baby, silicone, reus.
- 1 FACE MASK, FOR RESUSCITATOR, size 1, child 5-10kg, silicone, reus.
- 1 FACE MASK, FOR RESUSCITATOR, size 2, child 10-20kg, silicone, reus.
- 1 TUBE, GUEDEL, airways, No 00, neonate, autoclavable
- 1 TUBE, GUEDEL, airways, No 0, baby, autoclavable
- 1 TUBE, GUEDEL, airways, No 1, child, autoclavable
- 1 LARYNGOSCOPE, McIntosh, adult and baby, handle
- 1 LARYNGOSCOPE, McIntosh, adult and baby, handle diam. 28mm, blade, 0,1,2
- 1 SPHYGMOMANOMETER, ANEROID, baby/child w/3 cuffs 5 /7/10cm
- 1 STETHOSCOPE, duplex, pediatric, (dual-head chestpiece)
- 1 ENDOTRACHEAL TUBE, No.03, without cuff, sterile, disposable
- 1 ENDOTRACHEAL TUBE, No.04, without cuff, sterile, disposable
- 1 ENDOTRACHEAL TUBE No.4.5, without cuff, sterile, disposable
- 1 ENDOTRACHEAL TUBE No.05, without cuff, sterile, disposable
- 1 INTRODUCER FOR ENDOTRACHEAL TUBE, child
- 1 LAMP, POCKET PEN TORCH, plastic body, works with 2 batteries
- 1 HAMMER, PERCUSSION, 20cm
- 1 BLOOD SUGAR TEST STRIPS
- 1 THERMOMETER, medical, mercury-free
- 1 PACK SKIN DISINFECTANT
- 1 SAFETY, IV CANNULA, G14 2.2x50mm, orange
- 1 SAFETY, IV CANNULA, G20 1.1x33mm, teflon, with inj. site, pink

1 SAFETY, IV CANNULA, G14 0.9x25mm, Teflon, with inj.site, blue
1 IV CANNULA FIXATION, plaster
1 INTRAOSSEOUS PUNCTURE DEVEICE, children
1 INFUSION SET, min 150cm, with air intake, inj.site, no needle
1 TOURNIQUET COTTON, 42x2.4cm, elastic, with buckle
1 TWEEZER mind.140mm
1 NEEDLE HOLDER
1 HEMOSTAT (Artery Forceps)
1 SCALPEL DISPOSABLE
1 SCISSORS, DRESSING, Lister, 18cm
6 COMPRESS, GAUZE, 10x10cm, 8plys, 17thr.sterile, 2pcs
2 FIXING BANDAGE (DIN 61634-FB8)
2 BANDAGE PACKET (DIN 13151M)
1 BANDAGE TOWEL (DIN 13152-A)
1 BANDAGE TOWEL (DIN 13152-BR)
8 WOUND DRESSING (DIN 13019-E 10x6)
1 ADHESIVE PLASTER
1 RESCUE SHEET, silver/gold insulating foil, 210cmx160cm
1 DISINFECTANT, HAND, bottle 50ml
1 GLOVE, SURGICAL, size 7, sterile, pair
1 GLOVE, SURGICAL, size 8, sterile, pair
4 GLOVE, EXAMINATION, Latex, none sterile, medium(7-8)
4 GLOVE, EXAMINATION, Latex, none sterile, Large (8-9)
2 FACE MASK, Protection, FFP3 with exhale, disposable
5 SYRINGE, 2ml, 2parts, disposable
5 SYRINGE, 10ml, 2parts, disposable
2 SYRINGE, 20ml, 2parts, disposable
10 SAFETY, SINGLE USE NEEDLE Gr.1
1 SHARP CONTAINER, safety disposable box, needle/cannula
1 DRAIN, THORACIC, CH28, straight, 50cm, sterile, disposable

1304 KIT, EMERGENCY, for adults, without drugs

Prepacked in a backpack with contents list featuring expiry dates
Completely equipped according to DIN 13232 A+B, adults
Without drugs, without oxygen

Including contents list:

1 SUCTION UNIT, hand operated, 600ml
1 TUBE SUCTION, CH18, 53cm. straight, sterile, disposable
1 RESUSCITATOR, ADULT, incl. 1 valve + 1 mask 5
1 PEEP valve
1 BACTERIAL FILTER FOR RESUSCITATOR
1 FORCEPS, CATH. INTRODUCING, MAGILL, 16cm, child extra small
1 LARYNGOSCOPE, McIntosh, baby, handle diam. 19 mm, blade 0,1,2
1 FORCEPS, CATH. INTRODUCING, MAGILL, 19cm, child small
1 FORCEPS, CATH. INTRODUCING, MAGILL, 24cm, adult
1 LARYNGOSCOPE, McIntosh, adult, handle diam. 28 mm, blade 2,3,4, with batteries
1 FACE MASK, RESUSCITATOR size 3, child 30-50kg, silicone, reus.
1 FACE MASK, RESUSCITATOR, size 4, adult 50-70kg, silicone, reus.
1 FACE MASK, RESUSCITATOR, size 5, child 70-100kg, silicone, reus
1 SPHYGMOMANOMETER, ANEROID, adult with 1cuff 14x54.5 cm
1 STETHOSCOPE, duplex, adult, (dual-head chestpiece)
1 TUBE, GUEDEL, airways, No 2, adult small, autoclavable
1 TUBE, GUEDEL, airways, No 3, adult, autoclavable
1 TUBE, GUEDEL, airways, No 4, adult large, autoclavable

1 LARYNGOSCOPE, McIntosh, adult and baby, handle
1 LARYNGOSCOPE, McIntosh, adult and baby, handle diam. 28mm, blade,3,4
1 SPHYGMOMANOMETER, ANEROID, baby/child w/3 cuffs 5 /7/10cm
1 STETHOSCOPE, duplex, pediatric, (dual-head chestpiece)
1 ENDOTRACHEAL,TUBE, No.06, without cuff, sterile, disposable
1 ENDOTRACHEAL,TUBE, No.07, without cuff, sterile, disposable
1 ENDOTRACHEAL,TUBE No.08, without cuff, sterile, disposable
1 INTRODUCER FOR ENDOTRACHEAL TUBE, adult
1 LAMP, POCKET PEN TORCH, plastic body, works with 2 batteries
1 HAMMER, PERCUSSION, 20cm
1 BLOOD SUGAR TEST STRIPS
1 THERMOMETER, medical, mercury-free
1 PACK SKIN DISINFECTANT
1 SAFETY, IV CANNULA, G18, 1.3x45mm, teflon,with inj.site green
1 SAFETY, IV CANNULA, G16, 2.0x50mm,teflon, with inj.site,grey
1 SAFETY, IV CANNULA, G24,0.7x19mm,teflon, with inj.site, yellow
1 IV CANNULA FIXATION, plaster
1 INTRAOSSEOUS PUNCTURE DEVEICE, adults
1 INFUSION SET, min 150cm, with air intake, inj.site, no needle
1 TOURNIQUET COTTON,42x2.4cm, elastic, with buckle
1 TWEEZER mind.140mm
1 NEEDLE HOLDER
1 HEMOSTAT (Artery Forceps)
1 SCALPEL DISPOSABLE
1 SCISSORS, DRESSING, Lister,18cm
6 COMPRESS, GAUZE, 10x10cm, 8plys,17thr.sterile, 2pcs
2 FIXING BANDAGE (DIN 61634-FB8)
2 BANDAGE PACKET (DIN 13151M)
1 BANDAGE TOWEL (DIN 13152-A)
1 BANDAGE TOWEL (DIN 13152-BR)
8 WOUND DRESSING (DIN 13019-E 10x6)
1 ADHESIVE PLASTER
1 RESCUE SHEET, silver/gold insulating foil, 210cmx160cm
1 DISINFECTANT, HAND, bottle 50ml
1 GLOVE, SURGICAL, size 7, sterile, pair
1 GLOVE, SURGICAL, size 8, sterile, pair
4 GLOVE, EXAMINATION, Latex, none sterile, medium(7-8)
4 GLOVE, EXAMINATION, Latex, none sterile, Large (8-9)
2 FACE MASK, Protection, FFP3 with exhale, disposable
5 SYRINGE, 2ml, 2parts,disposable
5 SYRINGE, 10ml, 2parts,disposable
2 SYRINGE, 20ml, 2parts,disposable
10 SAFETY, SINGLE USE NEEDLE Gr.1
1 SHARP CONTAINER, safety disposable box, needle/cannula
1 DRAIN, THORACIC, CH28, straight, 50cm, sterile, disposable

1304a MAJOR TRAUMA BACKPACK KIT, for adults and children, without drugs

Prepacked in a backpack with contents list (Excel file) featuring expiry dates
Completely equipped according to DIN 13232 A+B+C, adults and children
Without drugs, without oxygen

Including contents list:

1 SUCTION UNIT, hand operated, 600 ml
1 TUBE, SUCTION, CH 12, 53 cm, straight, sterile, disposable

1 TUBE, SUCTION, CH 14, 53 cm, straight, sterile, disposable
1 TUBE, SUCTION, CH 16, 53 cm, straight, sterile, disposable
1 TUBE, SUCTION, CH 18, 53 cm, straight, sterile, disposable
1 MUCUS EXTRACTOR, for newborn, CH 10, with HIV filter
1 RESUSCITATOR, ADULT, incl. 1 valve (DIN EN ISO 10651-4)
1 RESUSCITATOR, BABY, incl. 1 Paedi valve (DIN EN ISO 10651-4)
1 PEEP Valve
1 BACTERIAL FILTER FOR RESUSCITATOR
1 FACEMASK FOR RESUSCITATOR, size 5, adult 70-100kg, silicone, reusable
1 FACE MASK FOR RESUSCITATOR, size 4, adult 50-70kg, silicone, reusable
1 FACE MASK FOR RESUSCITATOR, size 3, adult 50-70kg, silicone, reusable
1 FACE MASK FOR RESUSCITATOR, size 2, child 10-20kg, silicone, reusable
1 FACE MASK FOR RESUSCITATOR, size 1, child 5-10kg, silicone, reusable
1 FACE MASK FOR RESUSCITATOR, size 0 A, neonates, silicone, reusable
1 TUBE, GUEDEL, airways, No 4, adult, autoclavable
1 TUBE, GUEDEL, airways, No 3, adult, autoclavable
1 TUBE, GUEDEL, airways, No 2, adolescent, autoclavable
1 TUBE, GUEDEL, airways, No 1, child, autoclavable
1 TUBE, GUEDEL, airways, No 0, baby, autoclavable
1 TUBE, GUEDEL, airways, No 00, neonate, autoclavable
1 LARYNXMASK/TUBE, 155-180CM
1 LARYNXMASK/TUBE, 125-155CM
1 LARYNXMASK/TUBE, 5-12 KG
1 LARYNGOSCOPE SET, for adult and baby: handle (diam. 28 mm with LED light) with autoclavable blades (size 0, 1, 2, 3, 4)
1 FORCEPS, CATH. INTRODUCING, MAGILL, 24cm, adult, autoclavable
1 FORCEPS, CATH. INTRODUCING, MAGILL, 16cm, child extra small, autoclavable
1 ENDOTRACHEAL, TUBE, No 03, without cuff, sterile, disposable
1 ENDOTRACHEAL, TUBE, No 04, without cuff, sterile, disposable
1 ENDOTRACHEAL, TUBE, No 4.5, without cuff, sterile, disposable
1 ENDOTRACHEAL, TUBE, No 05, without cuff, sterile, disposable
1 ENDOTRACHEAL, TUBE, No 06, with cuff, sterile, disposable
1 ENDOTRACHEAL, TUBE, No 07, with cuff, sterile, disposable
1 ENDOTRACHEAL, TUBE, No 08, with cuff, sterile, disposable
1 INTRODUCER FOR ENDOTRACHEAL TUBE, adult
1 INTRODUCER FOR ENDOTRACHEAL TUBE, child
1 SPHYGMOMANOMETER, ANEROID, baby/child w/3 cuffs 5 /7/10cm
1 SPHYGMOMANOMETER, ANEROID, adult with 1cuff 14x54.5 cm
1 STETHOSCOPE, duplex, adult, (dual-head chestpiece)
1 LAMP, POCKET PEN TORCH, plastic body, works with 2 batteries
1 HAMMER, PERCUSSION, 20 cm
1 BLOOD SUGAR TEST-STRIPS
1 THERMOMETER, medical, mercury-free
1 PACK SKIN DISINFECTANT
1 SAFETY, IV CANNULA, , 14 G 2,2 x 50 mm,orange
1 SAFETY, IV CANNULA, G 18, 1.3 x 45 mm, teflon, with inj. site, green
1 SAFETY IV CANNULA, G 16, 2.0 x 50 mm, teflon, with inj. site, grey
1 SAFETY IV CANNULA, G 20, 1.1 x 33 mm, teflon, with inj. site, pink
1 SAFETY IV CANNULA, G 22, 0.9 x 25 mm, teflon, with inj. site, blue
1 SAFETY IV CANNULA, G 24, 0.7 x 19 mm, teflon, with inj. site, yellow
6 IV CANNULA FIXATION, Plaster
1 INTRAOSSEOUS PUNCTURE DEVEICE, adults
1 INTRAOSSEOUS PUNCTURE DEVEICE, children
1 INFUSION SET, min. 150cm, with air intake, inj. site, no needle
1 TOURNIQUET, COTTON, 42x2.4cm, elastic, with buckle
1 TWEEZERS mind.140mm, autoclavable
1 NEEDLE HOLDER, autoclavable

- 1 HEMOSTAT (ARTERY FORCEPS), autoclavable
- 1 SCALPEL DISPOSABLE
- 1 SCISSORS, DRESSING, LISTER, 18 cm
- 6 COMPRESS, GAUZE, 10 x 10 cm, 8 plys, 17 thr., ster., 2 pcs
- 2 FIXING BANDAGE (DIN 61634- FB8)
- 2 BANDAGE PACKET (DIN 13151M)
- 1 BANDAGE TOWEL (DIN13152-A)
- 1 BANDAGE TOWEL (DIN13152-BR)
- 8 WOUND DRESSING (DIN 13019-E 10x6)
- 1 ADHESIVE PLASTER
- 1 RESCUE SHEET, silver/gold insulating foil, 210 cm x 160 cm
- 1 DISINFECTANT, HAND, bottle 1 ltr, 50ml
- 1 GLOVE, SURGICAL, size 7, sterile, pair
- 1 GLOVE, SURGICAL, size 8, sterile, pair
- 4 GLOVE, EXAMINATION, LATEX, none sterile, medium (7-8)
- 4 GLOVE, EXAMINATION, LATEX, none sterile, large (8-9)
- 2 FACE MASK, PROTECTION, FFP 3 with exhaler, disposable
- 5 SYRINGE, 2 ml, 2 parts, disposable
- 5 SYRINGE, 10 ml, 2 parts, disposable
- 2 SYRINGE, 20 ml, 2 parts, disposable
- 10 SAFETY, SINGLE USE NEEDLE GR1
- 1 SAFETY DISPOSAL BOX, CANNULA/ NEEDLE
- 1 DRAIN, THORACIC, CH 28, straight, 50 cm, sterile, disposable



1305 KNIFE, PLASTER, ESMACH, 18 cm



1306 LABEL, SELF-ADHESIVE, approx 30x70 mm

White
Writable

1307 LABEL, SELF-ADHESIVE, for syringes, small

Used to label 2 ml to 10 ml syringes
White
Writable

1309 LAMP, EXAMINATION, 1 spot, mobile, 230V

Lamp designed for basic hospital structures that performs essentially emergency activity and for maternity units
Power supply: 220-240V
Articulating arm, coated
Adjustable in height (approx 100-220cm)
Base with 4 or 5 branches; with 4 or 5 antistatic castors



1310 LAMP, FRONTAL, LED, head band, battery operated

Adjustable beam by rotation of the lamp head
Should work with AA batteries, preferably 3 batteries
Shockproof from 2m high, waterproof in the rain
Lamp with tiltable housing LED Lights
To be supplied with: batteries



1311 LAMP, OPERATING, 3 spots, 90.0000 Lux, mobile, 220V, + acc.

Mobile operating theatre lamp with 3 reflectors for surgery
Like model Doctor Mach: Trigenflex R96

Components:

- Lamp with 3 reflectors/spots with halogen bulb: 22.8/24V 50W
- Stand
- Handle for lamp, autoclavable
- Back-up system for battery-operation

Lamp:

- Light intensity: 90000 Lux
- Colour temperature: 4300°K
- Focusable light field size: 15-26cm
- Working distance: 70-140cm
- Diameter of the lamp: approx 48cm
- Total radiation at 100000 Lux: 389W/m²
- Temperature increase around the head: 2°C
- Needs a ceiling height minimum 3.60m
- Power input: 150W
- Total weight: approx 30 kg

Battery backup system:

- 4 hours autonomy
- Maintenance free battery included
- Deep discharge protection
- Automatic switch-over in case of power failure
- Built-in battery charger (also suitable for charging other batteries)
- - With capability for connection to Photovoltaic system (12 V).

Packaging:

- Dismantled 1 part lamp, 1 part stand + 3 spare bulbs/ 1 set fuses and 2 lamp handles
- The complete lamp is safely packed in a wooden crate

To be supplied with: Spare parts:

- 3 Bulb Halogen 22.8/24V 50W
- 3 Fuse
- 2 Handle

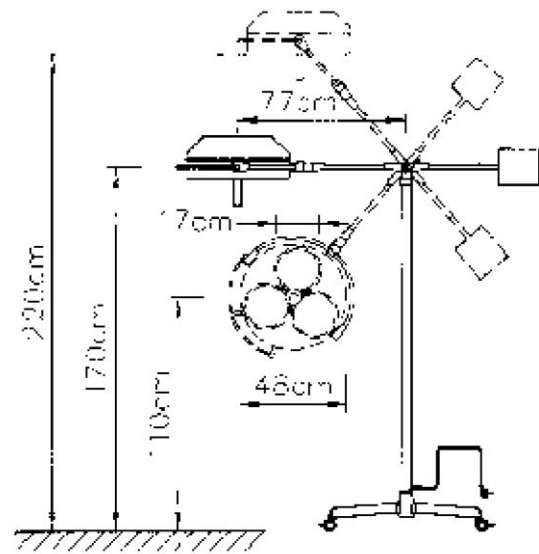
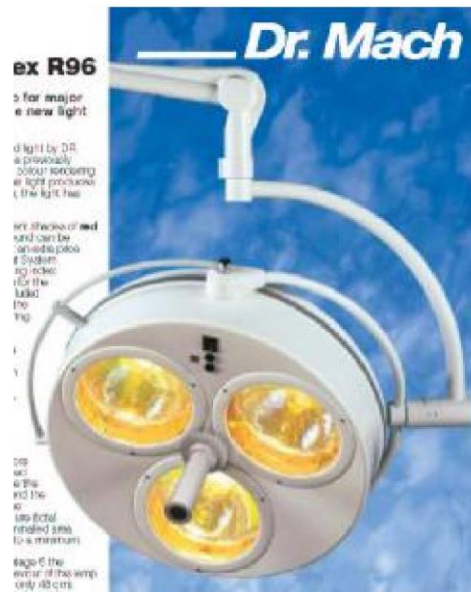

1312 LAMP, POCKET PEN TORCH, plastic body, works with 2 batteries



1313 LAMP, TORCH, medium, waterproof

2 batteries size D/LR20
To be supplied with: batteries



1314 LANCET, sterile, disposable

Lancets are sharp instruments with beveled point to take capillary samples by pricking a finger, heel or earlobe
Material: stainless steel

Sterile, disposable (immediately after use, dispose the lancet into a safety container)
Single use only

Packaging:

- 1 lancet packed in an individual sterilised peel-pack made of paper and/or plastic

Labeling:

- Exp date, lot number, items description, size, type of sterilization, manufacturer name, ref number, CE + Nr

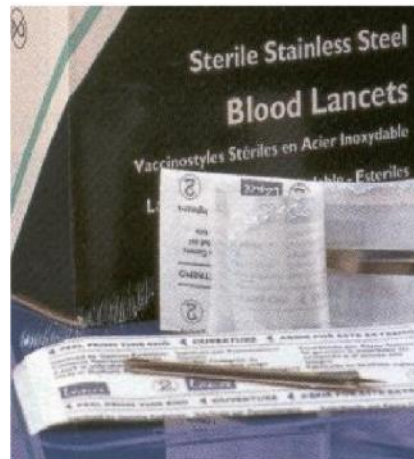

1315 LARYNGOSCOPE, McIntosh, adult and baby, handle diam. 28 mm, blade 0,1,2,3,4

To expose and view larynx and its surrounding structures, necessary for successful intubation through epiglottis or other procedures

Used in anaesthesia/resuscitation

Material:

- Handle: stainless steel or chromium plated, slightly rigged
- Depressor/laryngoscope blade: stainless steel, curved or straight

A laryngoscope is made of the following parts:

- Hollow handle type fit 2 batteries
- Spatula/blade: McIntosh type, slightly curved blade with a small bulbous end tip fixed to handle with a hook on system

Illumination: battery in the handle + lamp with the blade or fiber optics

Bulb for blade or blade with fiber optics, each blade has a single bulb removable for cleaning

Handle type C, diameter 28 mm, for battery LR14

5 curved McIntosh laryngoscope blades:

- Size 0: length/blade: 55 mm, newborn
- Size 1: length/blade: 70 mm, baby
- Size 2: length/blade: 90 mm, child
- Size 3: length/blade: 110 mm, adult small
- Size 4: length/blade: 130 mm, adult large

Packaging: in solid protective case, name and characteristics of the article must appear on the packaging

To be supplied with: 2 batteries; dry cell, alkaline, LR14
2 spare bulb (if on bulb on tip);
1 spare bulb if fiber optics

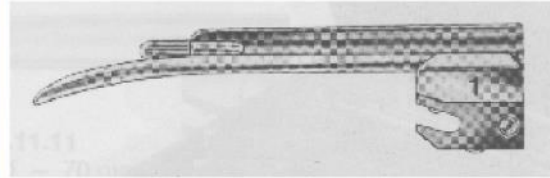

1316 LEAD SHEET, for X-Ray cassettes; 25 x 45 cm

To be used for covering part of X-Ray Cassettes when taking X-Rays
Lead sheet: 2 mm thickness

1317 LIGATURE, UMBILICAL, 100mx3mm, non sterile, roll for 500 lig.

Material: 100% cotton thread
Roll length 100 m, to produce 500 umbilical cord ligatures
Flat braided thread, 3 mm wide
One umbilical cord ligature = +/- length 20 cm
Non-absorbable, non-sterile, autoclavable
Needs to be sterilized or boiled before use
Packaging: 1 roll in suitable protective packaging
The following information must appear on the label of each packet:

- Length
- Width
- Material

1318 LOOP HOLDER, Kolle (240 mm) aluminium

Instrument composed of a handle and a loop, used to carry liquid or solid elements
Used to take a sample of sputum and spread it on a slide in order to search the acid fast bacilli
Material: aluminium holder with plastic handle according to Kolle

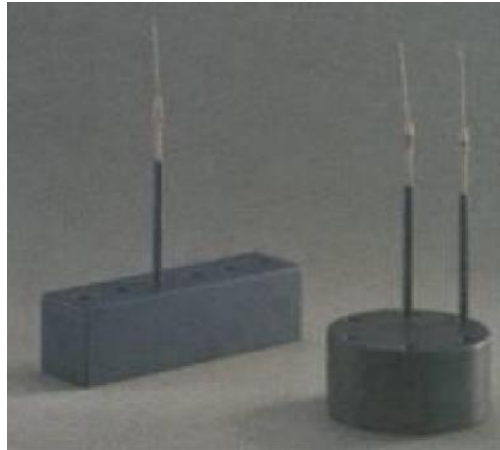

1319 LOOP, FOR LOOP HOLDER, diam 4 mm

Material: Nickel

Length of the wire: 45-55 mm

Diameter of the loop: 3-4 mm

Diameter of the wire: 0.6 mm

The wire loop is inserted into the holder

To be used with: LOOP HOLDER, Kolle (240 mm) aluminium

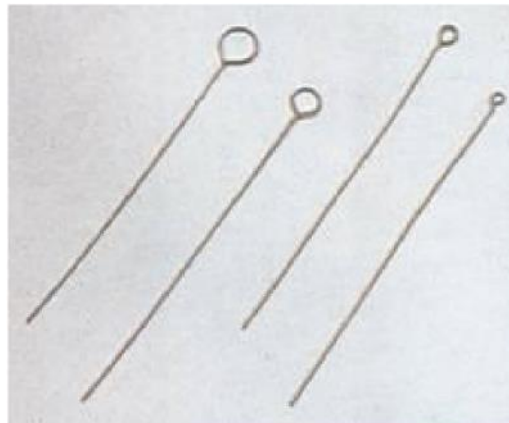

1320 MANDRIN FOR IV CANNULA G 16, grey

Sterile device to be introduced into the IV cannula in times of no drug administration

For single use

Packaging: in sterile peel-off sachet in protective carton box (100 units/box)

Other requirements: meets the EN-ISO 10555-1 and EN-ISO 20594-1 standards

Must be purchased from the same company that manufactures the cannula in order to ensure that the mandrin fits!

1321 MANDRIN FOR IV CANNULA G 18, green

Sterile device to be introduced into the IV cannula in times of no drug administration

For single use

Packaging: in sterile peel-off sachet in protective carton box (100 units/box)

Other requirements: meets the EN-ISO 10555-1 and EN-ISO 20594-1 standards
Must be purchased from the same company that manufactures the cannula in order to ensure that the mandrin fits!

1322 MANDRIN FOR IV CANNULA G 20, pink

Sterile device to be introduced into the IV cannula in times of no drug administration
For single use

Packaging: in sterile peel-off sachet in protective carton box (100 units/box)

Other requirements: meets the EN-ISO 10555-1 and EN-ISO 20594-1 standards
Must be purchased from the same company that manufactures the cannula in order to ensure that the mandrin fits!

1323 MANDRIN FOR IV CANNULA G 22, blue

Sterile device to be introduced into the IV cannula in times of no drug administration
For single use

Packaging: in sterile peel-off sachet in protective carton box (100 units/box)

Other requirements: meets the EN-ISO 10555-1 and EN-ISO 20594-1 standards
Must be purchased from the same company that manufactures the cannula in order to ensure that the mandrin fits!

1324 MANDRIN FOR IV CANNULA G 24, yellow

Sterile device to be introduced into the IV cannula in times of no drug administration
For single use

Packaging: in sterile peel-off sachet in protective carton box (100 units/box)

Other requirements: meets the EN-ISO 10555-1 and EN-ISO 20594-1 standards
Must be purchased from the same company that manufactures the cannula in order to ensure that the mandrin fits!



1325 MANDRIN FOR TUBE, ENDOTRACHEAL, adult

Mandrin used for introducing endotracheal tube
For intubation of adults

To be used with: TUBE, ENDOTRACHEAL



1326 MANDRIN FOR TUBE, ENDOTRACHEAL, child

Mandrin used for introducing endotracheal tube
For intubation of children
To be used with: TUBE, ENDOTRACHEAL



1329 MARKER PEN, permanent, large size, black



1330 MARKER PEN, permanent, medium size, black

1331 MARKER PEN, permanent, medium size, black, for use on sterile packs

For marking sterilization packaging material, using special autoclavable non- staining ink

without addition of oxylene/toluene
Designed for light touch writing to avoid damage of packaging material

1332 MARKER PEN, permanent, thin size, black

1333 MARKER, for white board, blue

Size: approx. 13 x 1.7cm

Medium tip

Ink:

- Non-toxic and neutral smell
- Environmental friendly

To be used with: WHITE BOARD, approx. 110 x 70 cm

1334 MARKER, for white board, green

Size: approx. 13 x 1.7cm

Medium tip

Ink:

- Non-toxic and neutral smell
- Environmental friendly

To be used with: WHITE BOARD, approx. 110 x 70 cm

1335 MARKER, for white board, red

Size: approx. 13 x 1.7cm

Medium tip

Ink:

- Non-toxic and neutral smell
- Environmental friendly

To be used with: WHITE BOARD, approx. 110 x 70 cm

1336 MARKER, X-RAY, + (plus), lead made

1337 MARKER, X-RAY, LETTER "L/R", lead made

Double clip-on marker with "R" on one side and "L" on the other side

To fit all standard cassettes

Material: stainless steel

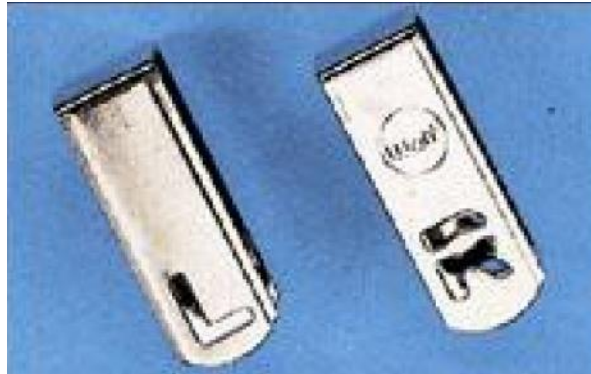

1338 MASK, ANAESTHESIA, size 0 A, neonates, silicone, reusable

Resuscitation face mask for neonate and very small children

Can also be used with paediatrics breathing circuit

Manufacturer e.g. Ambu®

Component/material:

- Dome: polysulphone, transparent
- Cushion/cuff: Chloroprene mask/ AO, filled with foam (no adjustable inflation) with 15mm ISO connectors

Can be dismantled for cleaning and sterilisation (autoclave 121°C

Unit presentation: 1 mask with user manual/maintenance manual, multilingual, in a protective plastic bag

Packaging:

Protective wrapping

The name and characteristics of the article must appear on the packaging

To be used with: RESUSCITATOR AMBU, BABY, incl. 1 Paedi valve

1339 MASK, ANAESTHESIA, size 0, child 5-10kg, silicone, reusable

Face mask intended to be connected to a self-inflating bag or an anesthesia balloon for ventilation assistance in children

Size 0, child 5-10 kg

Rigid moulded shell, made of transparent polysulphon

Silicone rubber rim:

- Flexible
- Inflatable (pressure can be adjusted)
- Anti-leak

Silicone rubber connector, 22 mm diameter (Adapter might be necessary!)

Iron hooks for fixing the headband

Each shell must be marked with the number corresponding to the size of the mask

Autoclavable

Unit presentation: non sterile

1340 MASK, ANAESTHESIA, size 2, child 10-20kg, silicone, reusable

Face mask intended to be connected to a self-inflating bag or an anesthesia balloon for ventilation assistance in children

Size 2, child 10-20 kg

Rigid moulded shell, made of transparent polysulphon

Silicone rubber rim:

- Flexible
 - Inflatable (pressure can be adjusted)
 - Anti-leak
- Silicone rubber connector, 22 mm diameter (Adapter might be necessary!)
Iron hooks for fixing the headband
Each shell must be marked with the number corresponding to the size of the mask
Autoclavable
Unit presentation: non sterile



1341 MASK, ANAESTHESIA, size 3, child 30-50kg, silicone, reusable

Face mask intended to be connected to a self-inflating bag or an anesthesia balloon for ventilation assistance in children
Size 3, child 30-50 kg
Rigid moulded shell, made of transparent polysulphon
Silicone rubber rim:

- Flexible
- Inflatable (pressure can be adjusted)
- Anti-leak

Silicone rubber connector, 22 mm diameter (Adapter might be necessary!)
Iron hooks for fixing the headband
Each shell must be marked with the number corresponding to the size of the mask
Autoclavable
Unit presentation: non sterile

1342 MASK, ANAESTHESIA, size 4, adult 50-70kg, silicone, reus.

Face mask intended to be connected to a self-inflating bag or an anesthesia balloon for ventilation assistance in children
Size 4, adult 50-70 kg
Rigid moulded shell, made of transparent polysulphon
Silicone rubber rim:

- Flexible
- Inflatable (pressure can be adjusted)
- Anti-leak

Silicone rubber connector, 22 mm diameter (Adapter might be necessary!)
Iron hooks for fixing the headband
Each shell must be marked with the number corresponding to the size of the mask
Autoclavable
Unit presentation: non sterile

1343 MASK, ANAESTHESIA, size 5, adult 70-100kg, silicone, reusable

Face mask intended to be connected to a self-inflating bag or an anesthesia balloon for ventilation assistance in children

Size 5, adult 70-100 kg

Rigid moulded shell, made of transparent polysulphon

Silicone rubber rim:

- Flexible
- Inflatable (pressure can be adjusted)
- Anti-leak

Silicone rubber connector, 22 mm diameter (Adapter might be necessary!)

Iron hooks for fixing the headband

Each shell must be marked with the number corresponding to the size of the mask

Autoclavable

Unit presentation: non sterile



1344 MASK, SURGICAL, standard size, disposable

Mask covering lower part of the face used by medical/surgical staff

Material: non-woven, impermeable to liquids

Filtration level: > 95%

Air permeability: 1.89 mm H₂O

Tests made with particles of 3 microns

Four strips for tying behind neck

Non sterile, disposable

Packaging: carton, no. of units displayed on packaging

Other requirements: meets the EN 149 standard



1345 MATERIAL, SURGICAL, green cotton, for drapes and gowns, 100 m, roll

Material: 100% cotton or 50% cotton and 50% polyester

Reusable woven fabrics

Designation: 100% cotton cretonne fabric

- Number of threads/cm: warp: 24, weft: 24
- Metric count: warp: 28, weft: 28
- Weight per m²: 180 g

Polyester/ cotton:

Designation: Woven cotton 50% cotton / 50% polyester fabric, heat set

- Number of threads/cm: warp: 24, weft: 22
- Metric count: warp: 28, weft: 28
- Weight per m2: 175g

Both woven fabric material are suitable for normal washing, withstand boiling & autoclaving and are resistant to chlorine 5%

Colour: green

Size: 160 cm x 100 m

Roll in double layer (width 80 cm)

Other requirements: maximum width of pack: **100 cm!**
meets G1 DIN 61621



1346 MATTRESS, to fit hospital bed

Washable

Flame retardant

Easy to disinfect

Mattress should have watertight, urine proof and flame retardant cover

High-density foam filling, minimum density of 30 kg/m³

Thickness: approx 4cm

Length and width to match the bed size of HOSPITAL BED

Vacuum packing to minimize packing size

To be used with: HOSPITAL BED

1348 MEASURING JUG, 2L, graduated, shock proof transparent plastic

1349 MEGAPHONE, 25W, with micro + 8 C/R14 batteries 1.5V

Handle with on/off switch

Separate microphone with lock function, choice between siren or speech

With carrying strap

Rated power: 25W

Range: 600m

Microphone sensitivity: -36±1dB (0dB = 1V/pa)

Frequency response: 500 Hz – 8 KHz

Power supply: 12Vdc (8 x 1.5V D battery)

Net weight: 1500g

Dimensions horn: Ø240mm x 330mm

To be supplied with: 8 x 1.5V D battery



1350 MICRO TEST TUBES, with lid, 1.5 ml

Polypropylene centrifuge micro test tubes with hinged membrane lid used to centrifuge or store liquid substances
Like Eppendorf Safe Lock
With graduation
Colourless
Lid to be leak proof
With membrane in the middle of the lid to allow aerosol-free removal of biohazardous substances



1351 MICROPIPETTING AID "micro-classic"

Micro pipetting aid with suction tube and adapter for disposable micropipettes with ring mark and other small volume pipettes up to approx. 1 ml

Material: plastic, rubber and metal

Components: handle with venting bottom, thumb wheel, suction tube, spring clip, adapter and adapter support

Size:

- Length 180 mm
- Width 23 mm
- Height 17 mm

1352 MICROPIPETTOR, ADJUSTABLE, 10-100 µl

Automatic pipette used to take accurately small liquid samples

Material: polypropylene

Tip release

Volume adjustable

To be used with: PIPETTE TIP, YELLOW, 10-100 μ l



1353 MICROPIPETTOR, ADJUSTABLE, 200-1000 μ l

Automatic pipette used to take accurately small liquid samples

Material: polypropylene

Tip release

Volume adjustable

To be used with: PIPETTE TIP, BLUE, 200-1000 μ l



1354 MICROSCOPE BINOCULAR, LABORATORY

For transmitted light microscopy

Stable, robust microscope

Like Olympus CX 31

Optical system:

- US (Universal infinity corrected optical system)
- Illumination: built in transmitted Koehler illuminator, 6V/30 Watt halogen bulb 100-120V/220-240V
- Focusing: stage height movement by roller guide (rack & pinion)
- Stroke per rotation: 36.8mm
- Full stroke range: 25mm
- Upper limit stopper by simplified pre-focusing dial
- Tension adjustment on coarse focus adjustment knob
- Revolving nosepiece: fixed quadruple nosepiece with inward tilt
- Binocular observation tube: field number 20
- Tube inclination: 30°
- Interpupillary distance adjustment range: 48-75mm

Stage:

- Size: 188(W) x 134(D) mm
- Movement range: 76 mm X-direction x 50 mm Y-direction
- Specimen holder: double slide holder

Rubber grip: Equipped as standard

Condenser:

- Type: Abbe condenser, with built in, daylight filter; NA. 1.25 with oil immersion
- Aperture iris diaphragm: built in

Objectives: Achromat 10x, 40x and Plan achromat 100x

Eyepiece: 10x Field Number 20

Packaging: individually packed in a protective carrying case

To be supplied with: 3 spare bulbs

- 1 dust protection cover
- 1 bottle immersion oil 10ml



1356 MONITOR, patient vital sign, with accessories

Suitable for adult, paediatric and neonatal patients
Built to withstand harsh environments
Resistant to dust and water jets (IP55 Rating)
Large colour LCD-display
Up to 10 hrs battery use
Adjustable alarms

Monitoring parameters:

- SpO2
- NIBP
- Pulse rate

Weight: approx.3.5 kg incl. battery

To be supplied with: SpO2 sensors for adults, child and neonates
NIBP cuff
Li-ion battery



1357 MOSQUITO NET rectangular 160 x 180 x 150 cm, perm. impregnated

Material: Polyester 100%, ISO1833

Fabrication: Wrap knitted, ISO8388

Denier: 75/100

Filament: Multi-filament 36 or higher

Mesh size: 25 holes/cm² (156 holes/inch²)

Weight: 40 g/m², ISO3801

Shrinkage: 5% maximum, ISO5077

Bursting strength: 605-710 KPa maximum, ISO2960

Fire safety: 16 (CFR1610)

Treatment: Long lasting insecticide (3-5years)

Large size: 160 x 180 x 150cm

Flammability tested: CPSC16 part 1610 cs 191-53 (US)

Net need to have an overlapping slit

All types of Mosquito nets are provided with necessary straps and loops

Packaging: in plastic or nylon bags and carry an instruction leaflet

1360 MUCUS EXTRACTOR, for newborn, CH 10, with HIV filter

Components:

- 1 transparent container (reservoir)
- 2 catheters one from the reservoir to operator's mouth and the second one for suction
- 1 HIV filter that prevents aspiration of the contents of the container
- 2 lids
- Self-adhesive identification label for new born identification

Material:

- Container: Polypropylene, medical grade
- Catheters: Polyvinylchloride, medical grade

Container size: 20ml

Filter:

- Hydrophobic HIV-tested
- Tolerates 105mm/Hg vacuum

- Prevents mucus transmission to user during procedure
- Catheters:
- 370mm; outer diameter: 3.3mm (CH 10)
 - One with mouthpiece to generate suction from operator's mouth
 - Second is the suction to aspirate the baby
- Sterilized by ethylene oxide, sterile, disposable
- Packaging:
- individual sterilized peel-packs made of paper and/or plastic
 - Each peel-pack to be clearly marked with expiry date and batch number



1362 NEBULIZER, compressor type

- For inhalation, treatment and respiration
Air humidification, dosed medicament inhalation, especially to be used for the treatment of respiratory infections in children
Compressor system
Venturi nebulizing system, reusable
Nebulizing chamber and chamber lid to be sterilizable in steam
Interruptors to prevent the nebulizer from operation without liquid
Exchangeable air- and bacterial-filter
Particle size < 5 µm
Air flow adjustable 0 - 6 l/min
Tubing sterilizable (silicone)
To be supplied with: 5 Masks, children, reusable
5 Masks, adults, reusable
5 Mouthpiece, reusable
10 Bacterial filter elements

1363 SAFETY NEEDLE, HYPODERMIC, G 24, 0.55 x 25 mm, No. 17, purple

- Components and materials:
- Tube or cannula made of stainless steel
 - Base made of polypropylene (PP)
 - Cap made of polypropylene (PP)
 - Safety needle guard
 - Safety shield/mechanism made of polypropylene (PP)
- Cannula:
- Normal or thin walled
 - Long beveled (angle inferior or equal to 13°= or short beveled (angle between 13° and 19°)
 - Silicone-coated to facilitate insertion
- Base:
- Colour-coded
 - Allows the needle to be connected to a syringe or other injection device
 - Formed by a conical, female, Luer connection

- Designed in a way that prevents the needle from rolling on a flat surface
- Cap:
Protects the cannula and its bevel, and insures sterility of the needle
- Safety shield/mechanism:
- Robust safety shield or box covers entire needle or needle is retracted
 - Can be activated with the thumb, finger or any flat surface
 - Maximizes protection from sharps injury
- Hypodermic needles can be identified by the following inscription: "Hypodermic needle", 2 numbers separated by a dash for the length and the diameter of the cannula (both in mm), long bevel (LB) or short bevel (SB)
- Sterile, disposable, single use
- Packaging: one needle in individual sterile peel pack made of paper and/or plastic, protective carton packaging (100 units/box)
- Labeling: exp date, lot number, items description, needle size, type of sterilization, manufacturer name, ref number, CE + Nr
- Other requirements:** Conforms to EN standard 9626
Meets the specifications of the norms: EN-ISO 7864-1,
EN-ISO 6009 and EN-ISO 20594-1

1364 SAFETY NEEDLE, HYPODERMIC, G 20, 0,9 x 40 mm, No.1, yellow

- Components and materials:
- Tube or cannula made of stainless steel
 - Base made of polypropylene (PP)
 - Cap made of polypropylene (PP)
 - Safety needle guard
 - Safety shield/mechanism made of polypropylene (PP)
- Cannula:
- Normal or thin walled
 - Long beveled (angle inferior or equal to 13°= or short beveled (angle between 13° and 19°)
 - Silicone-coated to facilitate insertion
- Base:
- Colour-coded
 - Allows the needle to be connected to a syringe or other injection device
 - Formed by a conical, female, Luer connection
 - Designed in a way that prevents the needle from rolling on a flat surface
- Cap:
Protects the cannula and its bevel, and insures sterility of the needle
- Safety shield/mechanism:
- Robust safety shield or box covers entire needle or needle is retracted
 - Can be activated with the thumb, finger or any flat surface
 - Maximizes protection from sharps injury
- Hypodermic needles can be identified by the following inscription: "Hypodermic needle", 2 numbers separated by a dash for the length and the diameter of the cannula (both in mm), long bevel (LB) or short bevel (SB)
- Sterile, disposable, single use
- Packaging: one needle in individual sterile peel pack made of paper and/or plastic, protective carton packaging (100 units/box)
- Labeling: exp date, lot number, items description, needle size, type of sterilization, manufacturer name, ref number, CE + Nr
- Other requirements:** Conforms to EN standard 9626
Meets the specifications of the norms: EN-ISO 7864-1,
EN-ISO 6009 and EN-ISO 20594-1

1365 SAFETY NEEDLE, HYPODERMIC, G 21, 0.8 x 40 mm, No.2, green

Components and materials:

- Tube or cannula made of stainless steel
- Base made of polypropylene (PP)
- Cap made of polypropylene (PP)
- Safety needle guard
- Safety shield/mechanism made of polypropylene (PP)

Cannula:

- Normal or thin walled
- Long beveled (angle inferior or equal to 13°= or short beveled (angle between 13° and 19°)
- Silicone-coated to facilitate insertion

Base:

- Colour-coded
- Allows the needle to be connected to a syringe or other injection device
- Formed by a conical, female, Luer connection
- Designed in a way that prevents the needle from rolling on a flat surface

Cap:

Protects the cannula and its bevel, and insures sterility of the needle

Safety shield/mechanism:

- Robust safety shield or box covers entire needle or needle is retracted
- Can be activated with the thumb, finger or any flat surface
- Maximizes protection from sharps injury

Hypodermic needles can be identified by the following inscription: "Hypodermic needle", 2 numbers separated by a dash for the length and the diameter of the cannula (both in mm), long bevel (LB) or short bevel (SB)

Sterile, disposable, single use

Packaging: one needle in individual sterile peel pack made of paper and/or plastic, protective carton packaging (100 units/box)

Labeling: exp date, lot number, items description, needle size, type of sterilization, manufacturer name, ref number, CE + Nr

Other requirements: Conforms to EN standard 9626

Meets the specifications of the norms: EN-ISO 7864-1,
EN-ISO 6009 and EN-ISO 20594-1

1366 SAFETY NEEDLE, HYPODERMIC, G 22, 0,7 x 30 mm, No.12, black

Components and materials:

- Tube or cannula made of stainless steel
- Base made of polypropylene (PP)
- Cap made of polypropylene (PP)
- Safety needle guard
- Safety shield/mechanism made of polypropylene (PP)

Cannula:

- Normal or thin walled
- Long beveled (angle inferior or equal to 13°= or short beveled (angle between 13° and 19°)
- Silicone-coated to facilitate insertion

Base:

- Colour-coded
- Allows the needle to be connected to a syringe or other injection device
- Formed by a conical, female, Luer connection
- Designed in a way that prevents the needle from rolling on a flat surface

Cap:

Protects the cannula and its bevel, and insures sterility of the needle

Safety shield/mechanism:

- Robust safety shield or box covers entire needle or needle is retracted
 - Can be activated with the thumb, finger or any flat surface
 - Maximizes protection from sharps injury
- Hypodermic needles can be identified by the following inscription: "Hypodermic needle", 2 numbers separated by a dash for the length and the diameter of the cannula (both in mm), long bevel (LB) or short bevel (SB)
- Sterile, disposable, single use
- Packaging: one needle in individual sterile peel pack made of paper and/or plastic, protective carton packaging (100 units/box)
- Labeling: exp date, lot number, items description, needle size, type of sterilization, manufacturer name, ref number, CE + Nr
- Other requirements:** Conforms to EN standard 9626
Meets the specifications of the norms: EN-ISO 7864-1,
EN-ISO 6009 and EN-ISO 20594-1

1368 SAFETY NEEDLE, HYPODERMIC, G 27, 0,42 x 19 mm, No.20, gray

- Components and materials:
- Tube or cannula made of stainless steel
 - Base made of polypropylene (PP)
 - Cap made of polypropylene (PP)
 - Safety needle guard
 - Safety shield/mechanism made of polypropylene (PP)
- Cannula:
- Normal or thin walled
 - Long beveled (angle inferior or equal to 13°= or short beveled (angle between 13° and 19°)
 - Silicone-coated to facilitate insertion
- Base:
- Colour-coded
 - Allows the needle to be connected to a syringe or other injection device
 - Formed by a conical, female, Luer connection
 - Designed in a way that prevents the needle from rolling on a flat surface
- Cap:
- Protects the cannula and its bevel, and insures sterility of the needle
- Safety shield/mechanism:
- Robust safety shield or box covers entire needle or needle is retracted
 - Can be activated with the thumb, finger or any flat surface
 - Maximizes protection from sharps injury
- Hypodermic needles can be identified by the following inscription: "Hypodermic needle", 2 numbers separated by a dash for the length and the diameter of the cannula (both in mm), long bevel (LB) or short bevel (SB)
- Sterile, disposable, single use
- Packaging: one needle in individual sterile peel pack made of paper and/or plastic, protective carton packaging (100 units/box)
- Labeling: exp date, lot number, items description, needle size, type of sterilization, manufacturer name, ref number, CE + Nr
- Other requirements:** Conforms to EN standard 9626
Meets the specifications of the norms: EN-ISO 7864-1,
EN-ISO 6009 and EN-ISO 20594-1

1369 SAFETY NEEDLE, SCALP VEIN, G 21, 0.8 x 19 mm, green

- Butterfly needle
- Thin-gauge needle designed for use in the veins of the scalp or other small veins, especially

in infants and children

Components and materials:

- Needle: stainless steel
- Safety needle guard
- Tube: PVC or polyurethane (PUR)
- Connector: PVC or polyurethane (PUR)
- Protecting cap: PVC or polyurethane (PUR)

Needle:

- Mounted on a base of variable size, which has two flexible fins that are used for anchoring and fixing the needle
- Usually triple beveled
- Silicone-coated to make the insertion easier

Tube:

- Supple
- Length: between 10 and 30 cm
- Internal volume: between 0.15 and 2.5ml

The connector:

- Female Luer
- Usually interlocking
- Equipped with a bung, allowing an infusion set to be attached
- The sheath is open at both ends

These needles follow a colour code (visible on the fins), but this code is not yet standardized

The external diameter of the needle (in mm and gauge) is inscribed on the fins

Sterile, disposable

Packaging: one scalp vein needle in individual sterile peel pack made of paper and/or plastic, protective carton packaging (100 units/box)

Labeling: exp date, lot number, items description, needle size, type of sterilization, manufacturer name, ref number, CE + Nr

Other requirements: Meets the specifications of the norms: EN-ISO 10555-1, EN-ISO 6009 and EN-ISO 20594-1



1370 SAFETY NEEDLE, SCALP VEIN, G 23, 0.6 x 19 mm, blue

Butterfly needle

Thin-gauge needle designed for use in the veins of the scalp or other small veins, especially in infants and children

Components and materials:

- Needle: stainless steel
- Safety needle guard
- Tube: PVC or polyurethane (PUR)
- Connector: PVC or polyurethane (PUR)
- Protecting cap: PVC or polyurethane (PUR)

Needle:

- Mounted on a base of variable size, which has two flexible fins that are used for anchoring

and fixing the needle

- Usually triple beveled
- Silicone-coated to make the insertion easier

Tube:

- Supple
- Length: between 10 and 30 cm
- Internal volume: between 0.15 and 2.5ml

The connector:

- Female Luer
- Usually interlocking
- Equipped with a bung, allowing an infusion set to be attached
- The sheath is open at both ends

These needles follow a colour code (visible on the fins), but this code is not yet standardized

The external diameter of the needle (in mm and gauge) is inscribed on the fins

Sterile, disposable

Packaging: one scalp vein needle in individual sterile peel pack made of paper and/or plastic, protective carton packaging (100 units/box)

Labeling: exp date, lot number, items description, needle size, type of sterilization, manufacturer name, ref number, CE + Nr

Other requirements: Meets the specifications of the norms: EN-ISO 10555-1, EN-ISO 6009 and EN-ISO 20594-1



1371 SAFETY NEEDLE, SCALP VEIN, G 25, 0.5 x 19 mm, orange

Butterfly needle

Thin-gauge needle designed for use in the veins of the scalp or other small veins, especially in infants and children

Components and materials:

- Needle: stainless steel
- Safety needle guard
- Tube: PVC or polyurethane (PUR)
- Connector: PVC or polyurethane (PUR)
- Protecting cap: PVC or polyurethane (PUR)

Needle:

- Mounted on a base of variable size, which has two flexible fins that are used for anchoring

and fixing the needle

- Usually triple beveled
- Silicone-coated to make the insertion easier

Tube:

- Supple
- Length: between 10 and 30 cm
- Internal volume: between 0.15 and 2.5ml

The connector:

- Female Luer
- Usually interlocking
- Equipped with a bung, allowing an infusion set to be attached
- The sheath is open at both ends

These needles follow a colour code (visible on the fins), but this code is not yet standardized

The external diameter of the needle (in mm and gauge) is inscribed on the fins

Sterile, disposable

Packaging: one scalp vein needle in individual sterile peel pack made of paper and/or plastic, protective carton packaging (100 units/box)

Labeling: exp date, lot number, items description, needle size, type of sterilization, manufacturer name, ref number, CE + Nr

Other requirements: Meets the specifications of the norms: EN-ISO 10555-1, EN-ISO 6009 and EN-ISO 20594-1

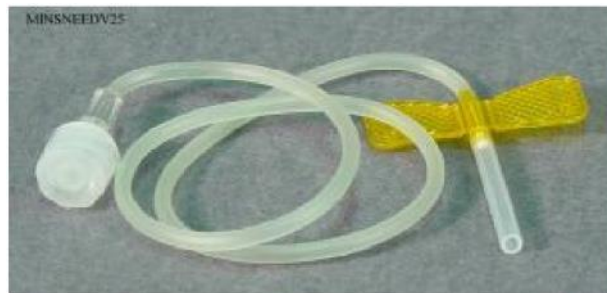

1372 SAFEYT NEEDLE, SPINAL, G 22, 0.7 x 75 mm, (LP and Rachian.), black

Components and materials:

- Cannula: stainless steel, without silicone
- Safety needle guard
- Stylet: stainless steel, without silicone
- Base: polypropylene or polyamide
- Cap: rigid plastic

Cannula:

- Cylindrical, ended at one end by a base which can be either opaque or translucent and at the other end by a short beveled tip, of a particular type known as "de Quinck"
- This short beveled tip is designed to separate the dural fibres rather than cutting them, reducing damage and therefore the loss of cerebrospinal fluid

Stylet:

- Same length as tube, fits properly to the lumen of the needle and has a projection that indicates the position of the bevel of the needle

Base:

- Colour-coded
- allows the needle to be connected to a syringe and is formed by a conical, female, Luer connection

Cap:

- Protects the cannula and its bevel and insures sterility of the needle

Spinal needles can be identified by colour-code and 2 numbers: the first for the external diameter and the second for the length of the cannula (both in mm)

Sterile, disposable

Packaging: one needle in individual sterile peel pack made of paper and/or plastic, protective carton packaging (20 units/box)

Labeling: exp date, lot number, items description, needle size, type of sterilization, manufacturer name, ref number, CE + Nr

Other requirements: Meets the specifications of the norms: EN-ISO 7864-1, EN-ISO 6009 and EN-ISO 20594-1

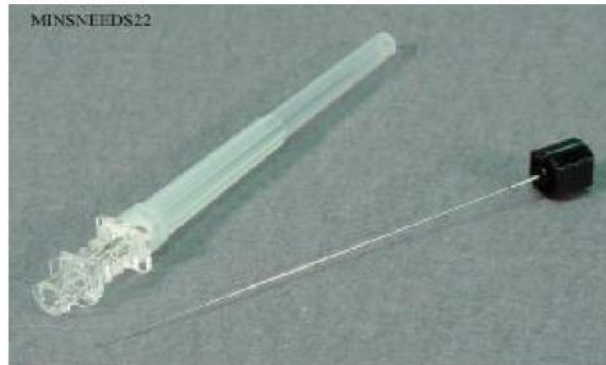

1373 SAFETY NEEDLE, SPINAL, G 25, 0.5 x 75 mm, (LP and Rachian.), orange

Components and materials:

- Cannula: stainless steel, without silicone
- Safety needle guard
- Stylet: stainless steel, without silicone
- Base: polypropylene or polyamide
- Cap: rigid plastic

Cannula:

- Cylindrical, ended at one end by a base which can be either opaque or translucent and at the other end by a short beveled tip, of a particular type known as "de Quinck"
- This short beveled tip is designed to separate the dural fibres rather than cutting them, reducing damage and therefore the loss of cerebrospinal fluid

Stylet:

- Same length as tube, fits properly to the lumen of the needle and has a projection that indicates the position of the bevel of the needle

Base:

- Colour-coded
- allows the needle to be connected to a syringe and is formed by a conical, female, Luer connection

Cap:

- Protects the cannula and its bevel and insures sterility of the needle

Spinal needles can be identified by colour-code and 2 numbers: the first for the external diameter and the second for the length of the cannula (both in mm)

Sterile, disposable

Packaging: one needle in individual sterile peel pack made of paper and/or plastic, protective carton packaging (20 units/box)

Labeling: exp date, lot number, items description, needle size, type of sterilization, manufacturer name, ref number, CE + Nr

Other requirements: Meets the specifications of the norms: EN-ISO 7864-1, EN-ISO 6009 and EN-ISO 20594-1

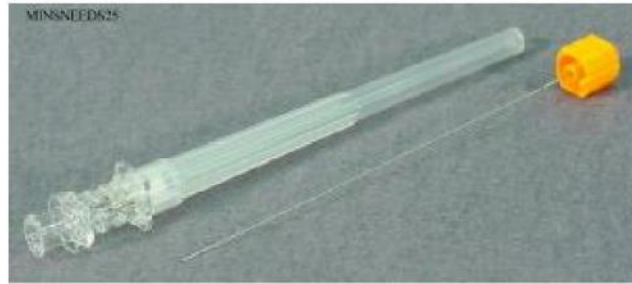

1374 NOTEBOOK, A4, 200 pages

With thick cover and back

1376 OIL SPRAY, 450ml, without silicone, for instruments

Oil spray without silicone, for oiling instruments with joints and locks
450ml spray with pressurized propellant gas (butane or propane)
Effective long protection against corrosion if used regularly
Suitable for steam sterilization (lubrication does not evaporate during sterilization)
Additive allowing the saturated steam to penetrate the oil film

Packaging:

- according to IATA regulations
- Aerosol non inflammable has to be packed under code 1950, class 2.2

Labeling:

- identification label in English with the number UN1950
- Extreme danger label, class 3: "Flammable liquid, 3"

Other requirements: complies with the specifications of the European Pharmacopoeia

1377 OIL, IMMERSION

Immersion oil is a synthetic oil essential for microscopy with a 100 x objective (immersion objective)

Viscous liquid

Hazchem code: 3Z

Hazard statement: Xn

Risk statement: R22, R40, R50/53

Safety statements: S36/37, S57, S60, S6, S25

Packaging: 100 ml plastic or glass bottle in protective wrapping or carton, labeled with expiry date and transport information

1378 OPTICAL TISSUE

Paper designed to clean microscope eyepieces, lenses and objectives

Free of mineral, does not scratch

Packaging: size depends on supplier, mostly boxes with 100 sheets



1380 OTOSCOPE-OPHTHALMOSCOPE (SET)

Instrument used for basic diagnostic in oto-rhino-laryngology (ear, nose, throat) and ophthalmology

Battery handle:

- Base for otoscope/ophthalmoscope with standard illumination 2.7 V
- Ø 28 mm for 2-battery type LR14
- Material: Brass, chrome plated
- Built-in rheostat illumination adjustment

Otoscope head:

- Pin contact fitting to handle
- Swivel-mounted lens: 4 x magnifier (removable for introducing instruments)
- Material: Polyamide P66

Auricle specula:

- size 2, 3 and 4 mm, reusable; autoclavable
- Material: polyamide P6

Ophthalmoscope head:

- Pin contact fitting to handle
- Lens with selection wheel permitting choice of corrective lenses from 0 to +20 and 0 to -20 dioptres
- Single large circle aperture

Bent-arm illuminator + pin-contact fitting: stainless steel chrome plated

Tongue blade holder: stainless steel chrome plated

Nasal speculum: stainless steel chrome plated

Laryngeal mirrors: n° 3 and 4, stainless steel chrome plated

Standard bulb

Packaging: in plastic rigid storage case

To be supplied with: 1 set of batteries, alkaline
2 spare bulbs



1381 OVERALL, disposable, incl. sealing tape

Personal Protective Equipment (PPE) coveralls with hood, boots and elastic wrists to protect against accidental spills, sprays and splashes of acids, bases, pesticides and other liquid chemicals

Like "Tyvek Classic Plus" Cat III Type 4,5,6

Coated with 1.25 mil of polyethylene in order to meet level B standards

Heat-sealed seams for increased holdout of liquids and dry particles > 1 µm

Storm-flapped zippers for extra protection from leakage

To be supplied with: TAPE, adhesive, for sealing PPE in sufficient amounts



1385 OXYGEN CONCENTRATOR, 5 litre/min

Used in Surgical Emergency Unit where oxygen cylinders/oxygen supply is irregular
Like Devilbiss Series 525 DS with OSD = (Oxygen Sensing Device)

Components:

- Casing with vertical layout + handle + 4 wheels.
- Angled control panel
- 1 Dust foam pre filter (rectangular): for large particles
- 2 felt filter (round): for fine particles
- 3 Bacterial filter: to capture particles up to 0.5µ
- Adjustable flow meter

- Refrigeration system
- Autoclavable humidifier
- Tubing for oxygen supply (10 m)
- 2 Y-pieces for tubing; for dividing supply to up to 2 more patients

Technical specifications:

Energy supply and requirement:

- Electrical rating: 220-230V, 50 Hz, 1,7 Amp; 230V, 60 Hz, 1.9 Amp
- Operating voltage range 187-255 V, 50 Hz; 218-253V, 60 Hz
- Power consumption average: 220-230V, 50 Hz = 365 Watts 230V, 60 Hz = 435 Watts

Oxygen delivery:

- O₂ delivery rate: 5 litres per minute (LPM)
- Maximum recommended flow: 5 LPM
- Outlet pressure: 8.5 psig (58.6 kPa)
- Oxygen % percentage: 1-5 LPM = 93% ± 3%

Operating altitude: 0-1500 m no degradation in performance 1500-3000m = ± 4%
performance drop at 5 LPM

3000-4000m = not recommended

To be operated in extremely dusty environments

Operating environment range: 10° to 35 ° C with humidity range of 30° of > 35 ° C - 4%
oxygen performance drop at 5 LPM

OSD alarm system by continuous monitoring of O₂ concentration by ultrasound: audible
alarm will be activated at 75 % O₂

Green light = > O₂ concentration = 85%

Yellow light = > O₂ concentration below 75%

Sound level: 50.5 decibel at overall average

Operating system: time cycle/ pressure swing

Pressure relief valve: 44 psig ± 3 psig (303 kPa ± 21 kPa)

Storage Conditions: Temperature 40°C to 70 °C

Humidity range of 10% to 100%, including condensation

Overall dimensions :70.5 x 40.6 x 35.6cm

Packaging: Unit presentation: 1 oxygen concentrator + 1 service set

To be supplied with: 1x Dust foam pre filter (rectangular): large particles (rectangular)
2x felt filter (round): for fine particles
3x bacterial filters

Other requirements: Conform to EN 60601-1+A1+A2 and EN 8359-1996

The concentrator must pass "military standard" shock, vibration and
corrosion tests



1386 OXYMETER, PULSE, with accessories

The pulse oximeter allows the continuous measurement of arterial oxygen saturation (% Sp O₂) as well as the pulse rate (beats/min). Used in Surgical Emergency Unit, in anaesthesia department or postoperative care as complementary to the oxygen concentrator

Components:

- Pulse oxymeter apparatus, chargeable with cable
- Cable, Patient
- Sensor: adult, child, neonatal
- Protecting case

Technical specification:

Pulse oxymeter for continuous use in adults, children and neonates

Portable

Audible pulse rate

Functions on batteries type C; LR14, 1.5V

Humidity: all combinations humidity/temperature, without condensation

Altitude: 0-6000 m

Size: approx. 20 x 8 x 14 cm

To be supplied with: 2 Finger probe, adult, reusable.

1 Finger probe, child, reusable

50 Adhesive tapes for neonates

1 Patient cable

1 Battery charger, complete

1 Protecting case, water resistant

4 Batteries, LR14, rechargeable

Packaging: Unit presentation: 1 pulse oxymeter with complete accessories: in a well packed protected carton box, including user and maintenance manual + warranty

The following information must appear on the packaging:

- Designation of item, manufacturer Ref Nr + CE with Nr
- Name and address of supplier (manufacturer)

1388 PAPER, STERILIZATION, 75 x 75 cm, non-woven, sheet

For use as inner/outer wrap of sterile goods or use as sterile field

60 g / m²

Colour: blue

Other requirements: complies with international standards EN 868

To be used with: TRAY, INSTRUMENT, GRID, 240 x 250 x 50 mm, stainless steel

1389 PAPER, STERILIZATION, 100 x 100 cm, non-woven, sheet

For use as inner/outer wrap of sterile goods or use as sterile field

60 g / m²

Colour: blue

Other requirements: complies with international standards EN 868

To be used with: TRAY, INSTRUMENT, GRID, 240 x 250 x 50 mm, stainless steel

1392 PENCIL no 2

Wooden pencil with softness no 2

1393 PENCIL SHARPENER 1 hole, conical

1394 PETRI DISH, double, glass, diam 100mm

Petri Dish is used to keep preparations in a wet chamber atmosphere or allow the even distribution of culture media

Material: Borosilicate glass

Size:

- Petri bottom glass dish Ø95 mm, H: 20 mm
- Petri cover glass Ø100 mm, H: 14 mm

Autoclavable

Distortion free transparency

Packaging: protective

1396 PILLOW CASE, white, for pillow 40 x 40 cm

Cotton 150g/m²

Washable at 90° C

To be used with: PILLOW, 40 x 40 cm

1397 PILLOW, 40 x 40 cm

Washable at 60° C

Filled with anti-allergic material

Vacuum packing to minimize packing size

1398 PIPETTE CLEANER, with cylinder

Pipette rinsing system made of two components:

Pipette cleaner container and pipette basket

Material: polypropylene

For pipettes up to 450 mm length

Size:

- Pipette cleaner container bottom diameter 165 mm, height 500 mm
- Pipette basket: bottom diam. 130 mm, height with handle: 650 mm

1399 PIPETTE FILLER, WITH THUMB-WHEEL LEVER, (Pi-pump), up to 10 ml

Aspiration and discharge system which is fitted onto a pipette to draw up and dispense a fluid

Suitable up to 10 ml

Aspiration wheel to fill and empty the pipette

Acid and solvent resistant

Not graduated

Autoclavable

Material: plastic



1400 PIPETTE TIP, BLUE, 200-1000 µl

Disposable tip used on an automatic micropipette (200 - 1000 µl) for safe and accurate pipetting of fluids

Material: polypropylene

Non sterile, disposable

Packaging: in 1000 pcs packs

To be used with: MICROPIPETTOR, ADJUSTABLE, 200-1000 µl



1401 PIPETTE TIP, YELLOW, 10-100 µl

Disposable tip used on an automatic micropipette (10 - 100 µl) for safe and accurate pipetting of fluids

Material: polypropylene

Non sterile, disposable

Packaging: in 1000 pcs packs

To be used with: MICROPIPETTOR, ADJUSTABLE, 10-100 µl div. 0.1 µl

1402 PIPETTE, GLASS, GRADUATED, 1 ml in 0.01 ml

Used to measure a fluid

Graduated in 0.01 ml

Zero marked at the top

Re-usable

1403 PIPETTE, GLASS, GRADUATED, 2 ml in 0.01 ml

Used to measure a fluid

Graduated in 0.01 ml

Zero marked at the top

Re-usable

1404 PIPETTE, GLASS, GRADUATED, 5 ml in 0.1 ml

Used to measure a fluid
Zero marked at the top
Re-usable, non-sterile
Packaging: protective bubble foil

1405 PIPETTE, GLASS, GRADUATED, 10 ml in 0.1 ml

Used to measure a fluid
Zero marked at the top
Re-usable, non-sterile
Packaging: protective bubble foil

1406 PIPETTE, WBC COUNT

Bulb pipette with a long stem with a capillary bore and a pointed tip to dilute blood with reagent

The bulb contains a white glass bead inside to homogenize the dilution

Material: glass, white enamel back

3 markings:

- 0.5 mark in the middle of the stem
- 1 mark at the junction between stem and bulb
- 11 mark above the bulb

Possible dilutions: 0,5:10 to 1:20

None sterile, re-usable



1407 PIPETTE, with bulb, plastic, 3 ml

Used to transfer liquid sample (body fluids or solutions) with bulb aspiration

Material: transparent polyethylene

Total capacity 3 ml

Bulb capacity 1.5 ml

Total length around 155 mm
Graduated
Number of drops per ml: 25
Non-sterile, disposable



1412 RACK, DRAINING, FOR GLASSWARE, wire mesh, stainless steel

Used to dry glassware and plastic ware
Material: stainless steel or metal wire coated with polyethylene
About 12 pegs for hanging hollowware with narrow hollow neck and 11 bendings for hanging hollowware with wider hollow neck
For hanging and standing with collecting dish
Feet protected with plastic caps
Size approx 420 x 170 x 300 mm

1413 RACK, ESR RATE

For erythrocyte sedimentation rate
Sarstedt Item No. 90.1090
Rack holds 10 ESR tubes (Sarstedt Item No. 06.1690.001)



1414 RACK, FOR MICROSCOPE SLIDES, Plexiglas, numbered; for 12 slides

Used to dry different preparations on microscope slides
12 slide slots consecutively numbered and with labeling strip
Size:

- Length 120 mm
- Width 90 mm
- Height 50 mm

1415 RAZOR, disposable

Instrument with a sharp cutting edge used for shaving hair
Plastic handle, app 8 cm long
Plastic head
Stainless steel blade, with cutting edge on one side, fixed into the head
Non-sterile, disposable
Packaging: carton, no. of units displayed on packaging

1416 REDON Drainage Set, 400 ml, complete, sterile, disposable

For close wound drainage under negative pressure post operatively with the option to operate one or two catheters simultaneously
Material: Plastic
With attached tube and needle
Easy discharge of air and contents



1417 REFRIGERATOR/FREEZER, approx.130 l, electric, 230V, w/ door lock (keyed)

Compressor type
Keyed door lock
For ambient temperatures of up to 43° C
Guaranteeing inside temperature range of +6° to -18° C
With corrosion protection, internal light
With freezing compartment
Other requirements: Tropical Climate Class ('T'), engineered for tropical climates

1418 RESCUE CARRYING CLOTH 200x70 cm, 6 handles

Material: polyester, PVC coated
Waterproof, easily washable
X ray translucent
Other requirements: should meet DIN EN 1865

1419 RESCUE SHEET, silver/gold insulating foil, 210 cm x 160 cm



1420 RESUSCITATOR, ADULT, incl. 1 valve + 1 mask 5

Used to assist ventilation in case of respiratory distress

Material:

- Bag: inner bag, hanging strap: EPDM rubber; outer cover: chloroprene rubber
- Valve, transparent plastic parts: polysulphone
- Valve, non transparent plastic parts, connector for reservoir: polyacetal
- Valve bellows and membranes: silicone rubber

Like Ambu Mark III

Total dead space: 11 ml

Maximum tidal volume of approx. 1300 ml

Expiration resistance: at 50 L/mn = approx. 0.20 kPa (2.0 cm H₂O)

Inspiration resistance: at 50 L/mn = approx. -0.41 kPa (-4.1 cm H₂O)

Self inflating bag

Size: length 300 mm, diameter 125 mm

Volume: 380ml, maximum volume for insufflations: 300 ml

Components:

- Outer bag cover with rigid neck section
- Inner bag with outlet connector
- Flanged inlet valve housing with membrane and strap

Can be disinfected with chemicals and sterilised by steam at 134°C / 18 min (prion procedure)

Patient valve:

- Single way valve (non-return valve)
- Transparent, unbreakable easy to dismantle (2 separate parts)
- Non sticking even in very humid conditions

Connector dimensions:

- Inlet connector (inspiration): 24 mm female
- Patient connector: 22/15 mm ISO
- Outlet connector (expiration): 30 mm male

Can be disinfected with chemicals and sterilised by steam at 121°C/134°C

Inlet valve:

- Inlet valve combined air/oxygen, complete with silicone membrane
- O₂ inlet nipple for use without O₂ reservoir
- Oxygen reservoir bag attachment, volume: approx 1.5 ltr

Operating temperature range: 20°C to 50°C

Total weight: approx 420 g

Storage temperature range: -40°C to 70°C

Packaging: protective wrapping

The name and characteristics of the article must appear on the packaging



1421 RESUSCITATOR, BABY, incl. 1 Paedi valve + 1 mask No OA

Device used for ventilation of new born, neonate, infant and children up to 4 years of age (maximum body weight = 20kg)

Material:

- bag: inner lining: EPDM rubber; outer cover: silicone rubber
- Patient valve housing and connectors: polysulphone
- Inlet valve: polyacetal
- Reservoir tube: polyethylene
- Valve shutters/valve membrane: silicone
- Mask: silicone or rubber

Like Ambu Baby

Expiration resistance: at 15 L/mn = approx. 0.45 kPa (4.5 cm H₂O)
at 5 L/mn = approx. 0.15 kPa (1.5 cm H₂O)

Inspiration resistance:

at 15 L/mn = approx. -0.37 kPa (-3.7 cm H₂O)
at 5 L/mn = approx. -0.05 kPa (-0.5 cm H₂O)

Self inflating bag

Size: length 240 mm, diameter 75 mm

Volume: 380 ml, maximum volume for insufflations 300 ml

Support ring outlet (connection to patient valve)

Support ring inlet with ear (connection to inlet valve combined air/oxygen)

Can be disinfected with chemicals and sterilized by steam at 121°C / 134°C

Patient valve (paedi valve):

- Weight: 18 g
- Minimum dead space: 0.8 cm with extremely low resistance
- Transparent, unbreakable, easy to dismantle (5 separate parts)
- Non-sticking even in very humid conditions

Connector dimensions according to BS/ISO:

- Inlet connector (inspiration): 15 mm
- Patient connector: 22/15 mm
- Outlet connector (expiration): 18 mm cylindrical

Can be disinfected with chemicals and sterilized by steam at 121°C / 134°C

Inlet valve combined air/oxygen, complete with silicone membrane and tube connector for oxygen reservoir tube

Reservoir tube oxygen:

- Length: 250 mm
- Volume: 100 ml

Operating temperature range: 20°C to 50°C

Storage temperature range: -40°C to 70°C

Packaging: protective wrapping

The name and characteristics of the article must appear on the packaging. Includes user

and maintenance manual, multilingual

To be supplied with: OA mask

Other requirements: except for valve resistance at adult flow rate
Comply with EN ISO 10651-4:2002

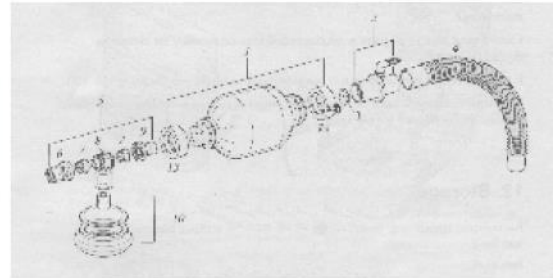

1422 ROD, MIXING, polystyrol

Used to mix a blood drop with a drop of blood grouping reagent
Applicator stick without mixing plate
Non sterile; disposable
Length 120 mm

1423 ROPE, POLYPROPYLENE, diam. 6 mm, twisted



1424 SAFELIGHT, for Blue/Green films, Fluo. lamp, 9 W/220V

For ceiling or wall mounting
15 watt, approx 45 cm fluorescent bulb
Complete with Blue/Green film filter
Bulb can be replaced with any standard 15 watt fluorescent daylight bulb
With pull chain and approx 2 m power cord, European plug
To be supplied with: 2 Starters 5-40W
Spare bulb



1425 SALT, COOKING, pack of 500 g

For preparation of 0.9% NaCl solution

1426 SAW, OSCILLATING, electric, for plaster and plastic

Electric oscillating plaster cutter for cutting bigger plastic bandage

Robust Construction

Small vibration

Oscillating frequency approx. 6500-24000 oscillations / min

Blade size approx 45 mm and 62 mm

Approx.500 watts

Approx. 5 meter long cable

Overload protected

Maintenance free

Packaging: in case

To be supplied with: 2 spare blades



1427 SCALE, BABY, suspended, 0-25 kg x 100 g, incl. 4 trousers (set)

To weigh children. Suitable for PMI, health centre, feeding centre or nutrition survey.

Dial type with two suspension hooks, practical to use, easy to transport, easy to read

Scale 0-25 kg x 100g

Material:

- Reading scale and scale cover: unbreakable polycarbonate or similar material

- Scale body and hooks: stainless steel
 - Weighing pants: strong water proof covered nylon
 - Carrying bag: strong water proof cover
- Horizontal bar may be attached to the hook, enabling big children to suspend themselves from the scale without having to use the weighing pants
Packaging: in shoulder carrying bag
To be supplied with: 4 weighing pants



1428 SCALE, BABY, with tray, 0-16 kg x 10 g

To weigh newborns, small babies in health centers, paediatric ward or maternity
Mechanical baby scale with sliding weights and 2 cursors: one for grams, one for Kg
Hard-wearing: ensured by sturdy steel housing and precise smooth-running sliding
Gently curved weighing tray with good eye-catcher
Capacity: 16 kg
Graduation: 10 g
Dimensions (WxHxD) approx: 550 x 190 x 305mm
Weight: approx 6kg
Material: coated steel



1429 SCALE, for adults (bathroom type), mechanic, 0-150kg/0,1kg

Measuring weight of adults in health and nutritional centers, as well as in hospitals
Heavy duty type of bathroom scale, consisting of a footplate with a scale window
Range: 0 - 150kg
Large easy reading calibrations, graduation scale of 100 grams
Shell of scale approx. 1 mm thick steel with frame
Platform and scale mechanism protected against rust and corrosion, preferably zinc coated
Dimensions (WxHxD): 300 x 105 x 460 mm
Material: plastic and coated steel
Other requirements: should conform to ISO standard or other international standard

CE approval class III



1430 SCALE, PRECISION, electronic, 0-400g/0,1 g

Measuring device, used to weigh accurately powders intended for preparation of stains and reagents

Like 'Kern 442-43N'

Weighing range: up to 400 g

Accuracy: 0.1 g

Material of casing: plastic

Dimension of casing: 145x185x55 mm

Dimension of weighing plate: Ø 120 mm

Storage: protect against dust and humidity

Battery supply: 9V block-battery

12 h operation time

Auto-off: in battery mode after 3 minutes

Weight 1 kg (net 0.5 kg)

To be supplied with: 2 x 9V block-battery

Test weight 200g



1431 SCALPEL WITH HANDLE, No 10, disposable

Surgical blade connected with a plastic handle

Material:

- Blade: Martensitic steel (quenched, magnetic steel), hardness 50 to 58 HCR

- Handle: Plastic

Sterile instrument (Gamma rays) /disposable

Shape: No 10

Packaging:

- 1 scalpel packed in an individual sterilised peel-pack made of paper and/or plastic

Labeling:

- Exp date, lot number, items description, size, type of sterilization, manufacturer name, ref number, CE + Nr

1432 SCALPEL WITH HANDLE, No 11, disposable

Surgical blade connected with a plastic handle

Material:

- Blade: Martensitic steel (quenched, magnetic steel), hardness 50 to 58 HCR
- Handle: Plastic

Sterile instrument (Gamma rays) /disposable

Shape: No 11

Packaging:

- 1 scalpel packed in an individual sterilised peel-pack made of paper and/or plastic

Labeling:

- Exp date, lot number, items description, size, type of sterilization, manufacturer name, ref number, CE + Nr

1433 SCALPEL WITH HANDLE, No 20, disposable

Surgical blade connected with a plastic handle

Material:

- Blade: Martensitic steel (quenched, magnetic steel), hardness 50 to 58 HCR
- Handle: Plastic

Sterile instrument (Gamma rays) /disposable

Shape: No 20

Packaging:

- 1 scalpel packed in an individual sterilised peel-pack made of paper and/or plastic

Labeling:

- Exp date, lot number, items description, size, type of sterilization, manufacturer name, ref number, CE + Nr

1434 SCISSORS, DRESSING, LISTER, 18 cm

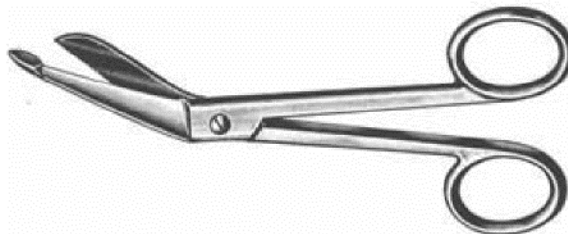

1435 SEALING WAX PLATE FOR HAEMATOCRIT CAPILLARIES

Plastic stand filled with modeling wax used to seal the haematocrit capillaries

The plastic stand is perforated with numbered cells on the sides

One stand can seal several hundred haematocrit capillaries

The numbered cells are designed to hold the sealed tubes up right and to label the samples

Material:

- Stand: plastic
 - Sealing paste: non drying vinyl plastic putty
- Plastic stand perforated with 24 numbered cells, middle part filled with sealing paste
Storage: sealing compound can be stored at 15 to 30°C for three years
To be use with: TUBE, CAPILLARY, MICRO-HAEMATOCRIT, 75 mm, heparinised

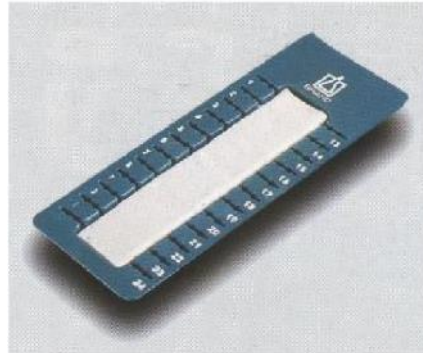

1436 SET, AMPUTATION, instruments

Complete set of instruments necessary for amputation of upper or lower limb

- 1 BOWL, ROUND, 100 ml, 80 x 35 mm, stainless steel
- 1 CASE, STERILIZING, 300x200x50mm, perforated w/textile filter
- 1 CURETTE, BONE, VOLKMANN, 22 cm, double-ended, fig. 3 and 5
- 1 FILE, BONE, 22 cm x 20 mm, flat
- 1 FORCEPS, BONE CUT., LISTON, 17 cm, standard, straight
- 1 FORCEPS, BONE CUT., LISTON-STILLE, 27 cm, double action, straight
- 1 FORCEPS, DRESSING, 14.5 cm, English pattern
- 8 FORCEPS, HEMOSTATIC, CRILE, 14 cm, curved
- 4 FORCEPS, HEMOSTATIC, R-OCHSNER, 16 cm/1x2 teeth, straight
- 2 FORCEPS, SPONGE, FOERSTER, 24cm, serrated jaws, straight
- 1 FORCEPS, TISSUE, 14.5 cm, 1x2 teeth, English pattern
- 5 FORCEPS, TOWEL CLAMP, BACKAUS, 13 cm
- 1 NEEDLE HOLDER, MAYO-HEGAR, 15 cm, standard
- 1 RASPATORY, FARABEUF, 150x13mm, light curved, sharp
- 1 RETRACTOR, VOLKMANN, 22 cm, 4 blunt prongs, 10 mm curve
- 1 RONGEUR, BONE, LUER, 18 cm x 10 mm, heavy pattern
- 1 SAW GIGLI, HANDLE, pair
- 6 SAW GIGLI, WIRE, 50 cm
- 1 SAW, AMPUTATION, SATTERLE, 29 cm, length of blade: 21 cm
- 1 SCALPEL, HANDLE, No 4 (for blades 20)
- 1 SCISSORS, DISSECTING, METZENBAUM, 18 cm, curved
- 1 SCISSORS, MAYO, 15.5 cm, straight
- 1 SCISSORS, MAYO, 17 cm, curved



1437 SET, AUTOTRANSFUSION

Components: Funnel, Spoon

Material: Stainless steel

Funnel:

- 10 cm diameter upper part
- Funnel hole 1 cm,
- Reusable, autoclavable

Spoon:

- Takes at least 50 ml
- Reusable, autoclavable

Presentation: Non-sterile, single packed

1438 SET, BASIC BONE SURGERY, complementary, instruments

Minimum instruments required for certain basic operations on bone:
spongiuous bone graft, sequestrectomy etc.

- 1 CASE, STERILIZING, 325x275x50mm, perforated w/textile filter
- 1 CURETTE, BONE, VOLKMANN, 22 cm, double-ended, fig. 2 and 4
- 1 CURETTE, BONE, VOLKMANN, 22 cm, double-ended, fig. 3 and 5
- 1 FILE, BONE, 22 cm x 20 mm, flat
- 1 FORCEPS, BONE CUT., LISTON, 17 cm, standard, straight
- 1 FORCEPS, BONE CUT., LISTON-STILLE, 27 cm, double action, angled
- 2 FORCEPS, BONE HOLD., VERBRUGGE, 27 cm x 12 mm, dismountable
- 2 FORCEPS, BONE HOLDING, FERGUSON, 21 cm/4 x 4 teeth
- 1 GOUGE, STILLE, 20 cm x 15 mm, straight
- 1 GOUGE, STILLE, 20 cm x 20 mm, straight
- 1 MALLET, 23 cm x 28 mm, 490 g, solid
- 1 OSTEOTOME, STILLE, 20 cm x 15 mm, straight
- 1 OSTEOTOME, STILLE, 20 cm x 20 mm, straight
- 1 RASPATORY, FARABEU, 150x13mm, light curved, sharp
- 2 RETRACTOR, BONE, HOHMANN, 29 cm x 34 mm
- 1 RETRACTOR, VOLKMANN, 22 cm, 1 sharp prong, 20 mm curve
- 1 RONGEUR, BONE, BANE, 18 cm x 5 mm, curved
- 1 RONGEUR, BONE, LUER, 15 cm x 5 mm, strong curve
- 1 RONGEUR, BONE, LUER, 18 cm x 10 mm, heavy pattern
- 1 RONGEUR, BONE, STILLE- LUER, 23 cm x 10 mm, double action



1439 SET, BASIC BONE SURGERY, CURETTES

- 1 CASE, STERILIZING, 260x150x50mm, perforated w/textile filter
- 1 CURETTE, BONE, VOLKMANN, 17 cm, fig. 0
- 1 CURETTE, BONE, VOLKMANN, 17 cm, fig. 00
- 1 CURETTE, BONE, VOLKMANN, 17 cm, fig. 000
- 1 CURETTE, BONE, VOLKMANN, 17 cm, fig. 0000
- 1 CURETTE, BONE, VOLKMANN, 17 cm, fig. 1
- 1 CURETTE, BONE, VOLKMANN, 17 cm, fig. 2
- 1 CURETTE, BONE, VOLKMANN, 17 cm, fig. 3
- 1 CURETTE, BONE, VOLKMANN, 17 cm, fig. 4
- 1 CURETTE, BONE, VOLKMANN, 17 cm, fig. 5
- 1 CURETTE, BONE, VOLKMANN, 17 cm, fig. 6



1440 SET, BASIC SURGERY, instruments

- 1 BOWL, ROUND, 100 ml, 80 x 35 mm, stainless steel
- 1 CASE, STERILIZING, 325x275x50mm, perforated w/textile filter
- 1 FORCEPS, DRESSING, 14.5 cm, English pattern
- 6 FORCEPS, HEMOSTATIC, CRILE, 14 cm, curved
- 6 FORCEPS, HEMOSTATIC, CRILE, 14cm, straight
- 6 FORCEPS, HEMOSTATIC, H-MOSQUITO, 12.5 cm, curved
- 2 FORCEPS, HEMOSTATIC, KOCHER, 14 cm/1x2 teeth, straight
- 2 FORCEPS, SPONGE, FOERSTER, 24cm, serrated jaws, straight
- 2 FORCEPS, TISSUE, 14.5 cm, 1x2 teeth, English pattern
- 2 FORCEPS, TISSUE, 14.5 cm, 1x2 teeth, English pattern

- 6 FORCEPS, TOWEL CLAMP, BACKAUS, 13 cm
- 1 NEEDLE HOLDER, MAYO-HEGAR, 18 cm, standard
- 2 RETRACTOR, LANGENBECK, 21 cm, 16 x 28 mm
- 1 RETRACTOR, SELF-RET., WEITLANER, 16 cm, 3 x 4 blunt prongs
- 2 RETRACTOR, VOLKMANN, 22 cm, 3 sharp prongs, 10 mm curve
- 1 SCALPEL, HANDLE, No 3 (for blades 10/11/15)
- 1 SCALPEL, HANDLE, No 4 (for blades 20)
- 1 SCISSORS, DISSECTING, METZENBAUM, 14 cm, curved
- 1 SCISSORS, DISSECTING, METZENBAUM, 18 cm, curved
- 1 SCISSORS, MAYO, 17 cm, curved
- 1 SUCTION TUBE, YANKAUER, 28 cm, standard



1441 SET, BONE WIRING & KIRSHNER, 8 sizes + instruments

Instruments for applying Kirschner and stainless steel cerclage wires, including consumable wires

- 1 CASE, STERILIZING, 300x140x40mm, perforated w/textile filter
- 1 PLIERS, FLAT NOSE, 14 cm, serrated jaws
- 1 PLIERS, FLAT NOSE, 16 cm, serrated jaws, heavy pattern
- 1 PLIERS, WIRE CUTTING, 22 cm, hard wire up to diam. 2.50 mm
- 1 VICE GRIP, 18 cm, self locking
- 1 WIRE PASSER, DEMEL, diam. 45 mm x 28 cm, blunt
- 1 WIRE PASSER, diam 45 mm x 23 cm, curved to left, blunt
- 1 WIRE, CERCLAGE, 1.00 mm x 10 m, stainless steel, coil
- 1 WIRE, CERCLAGE, 1.25 mm x 10 m, stainless steel, coil
- 10 WIRE, KIRSCHNER, 1.00 mm x 150 mm
- 10 WIRE, KIRSCHNER, 1.25 mm x 150 mm
- 10 WIRE, KIRSCHNER, 1.60 mm x 150 mm
- 10 WIRE, KIRSCHNER, 2.00 mm x 150 mm
- 10 WIRE, KIRSCHNER, 2.50 mm x 150 mm
- 10 WIRE, KIRSCHNER, 3.00 mm x 150 mm
- 1 WIRE, TIGHTENER, 23 cm, with handle and 2 pegs



1442 SET, BRUSHES, FOR BOTTLES

Brush set used to clean the different glass tubes and bottles

Material:

- Brush: silk
- Handle: metal

Sizes:

- Ø 18 mm
- Ø 30 mm with woolen tip
- Ø 45 mm

1443 SET, BRUSHES, FOR SMALL TUBES AND PIPETTES

Brush set used to clean the different glass tubes and pipettes

Material:

- Brush: silk
- Handle: metal

Sizes:

- Ø 5 mm
- Ø 10 mm
- Ø 15 mm

1444 SET, BURNS

3 BOWL, SPLASH, 5 l (275x125 mm), stainless.steel, autoclavable

1445 SET, CLOTHES, BABY

Set of baby clothes

Size 56, made of cotton

- Shirt
- Romper suit
- Socks
- Cap
- Jacket

1446 SET, CONIOTOMY, disposable

The coniotomy set enables the placement of a Mini-Trach cannula in the trachea utilizing the Seldinger (guide wire) technique.

This accurately guides the Mini-Trach cannula through the cricothyroid membrane, minimizing bleeding, avoiding surgical emphysema and misplacement due to misalignment of tissue

The kit contains all the necessary components to perform a mini-tracheotomy

Components:

- Guarded scalpel allows correct midline incision to be made with minimal risk of damage to the posterior tracheal wall
- 2 cm 16 G Tuohy needle to puncture the cricothyroid membrane and provide guide wire access to the trachea
- 10 ml syringe confirms correct placement of the needle by aspiration
- 50 cm flexible tipped guide wire to establish the cannulation route with minimal tracheal trauma
- 7 cm curved dilator enlarges the opening in the cricothyroid membrane for the smooth insertion of introducer and cannula
- Curved introducer aids introduction of the cannula
- 4mm ID thermo-sensitive blue line cannula
- Neck tapes for secure fixation of the cannula to the neck
- 10F suction catheter: low friction endobronchial catheter for initial suctioning following cannulation

Packaging: peel-off sachet, single unit packaging, sterile

1447 SET, CRANIOTOMY, complementary, instruments

Complementary instruments for craniotomy of open head trauma or trepanation of closed trauma

- 1 (drill, hand, cranial, Hudson) DRILL, CUSHING, 14mm, flat
- 1 (drill, hand, cranial, Hudson) PERFORATOR, D ERRICO, 16 mm
- 1 (drill, hand, cranial, Hudson) PERFORATOR, McKENSIE, 13 mm
- 1 CANNULA, TEAR DUCT, RANDOLPH, 15mm, Luer-Lock
- 1 CASE, STERILIZING, 325x275x50mm, perforated w/textile filter
- 1 DISSECTOR, DURA, OLIVECRONA, 18 cm, double ended 4 + 5 mm
- 1 DRILL, HAND, CRANIAL, HUDSON, complete set
- 1 FORCEPS, ADSON, 12 cm, 1x2 teeth
- 1 FORCEPS, ADSON, 12 cm, serrated jaws
- 1 FORCEPS, BONE CUT., LISTON, 17 cm, standard, straight
- 8 FORCEPS, HEMOSTATIC, DANDY, 14 cm, serrated, sideways curved
- 4 FORCEPS, HEMOSTATIC, H-MOSQUITO, 12.5 cm, straight
- 4 FORCEPS, HEMOSTATIC, H-MOSQUITO, 12.5 cm/1x2 teeth, curved
- 1 LEVER, BONE, LANE, 21 cm
- 1 RASPATORY, FARABEUF, 150x13mm, light curved, sharp
- 1 RETRACTOR, HOOK, SKIN, BARSKY, 15 cm, single prong, sharp
- 1 RONGEUR, BONE, FRIEDMANN, 14 cm x 2,5 mm, curved, delicate
- 1 RONGEUR, LAMINECTOMY, SPURLING-KERRISON, 20cm, jaws 5mm
- 1 SAW GIGLI, GUIDE, DeMARTEL, 33 cm
- 1 SAW GIGLI, HANDLE, pair
- 5 SAW GIGLI, WIRE, 50 cm
- 1 SCISSORS, VASCULAR, POTTS-SMITH, 19 cm, 60 degree, angled
- 1 SUCTION TUBE, FRAZIER, CH 12, 12.5 cm, angular



1448 SET, DENTAL EXTRACTION, instruments

Basic instruments for extraction of teeth

- 1 CASE, STERILIZING, 260x150x50mm, perforated w/textile filter
- 1 ELEVATOR, ROOTS, CRYER, # 1, left curved, sharp
- 1 ELEVATOR, ROOTS, CRYER, # 2, right, curved, sharp
- 1 ELEVATOR, ROOTS, CRYER, # 3, straight
- 1 FORCEPS, LEVIS, # 1, upper incisors and bicuspid
- 1 FORCEPS, LEVIS, # 7, upper premolars
- 1 FORCEPS, LEVIS, # 13, lower premolars
- 1 FORCEPS, LEVIS, # 17, upper molars right
- 1 FORCEPS, LEVIS, # 18, upper molar left
- 1 FORCEPS, LEVIS, # 22, lower molars
- 1 FORCEPS, LEVIS, # 33, lower roots
- 1 FORCEPS, LEVIS, # 51, upper roots
- 1 FORCEPS, LEVIS, # 73, lower molars
- 1 FORCEPS, LEVIS, # 74, low roots, incisors, bicuspid
- 1 FORCEPS, LEVIS, # 76, upper roots
- 1 FORCEPS, LEVIS, # 113, upper incisors and bicuspid



1449 SET, DISINFECTION, instruments

To be used for disinfection of operation area

- 1 BOWL, ROUND, 100 ml, 80 x 35 mm, stainless steel

1 FORCEPS, SPONGE, FOERSTER, 24cm, serrated jaws, straight

1450 SET, DRESSING, instruments

Complete basic instruments for change of wound dressing or removal of sutures

1 FORCEPS, DRESSING, 14.5 cm, English pattern

1 FORCEPS, HEMOSTATIC, PEAN, 14 cm, serrated jaws, half way

1 KIDNEY DISH, large, 275x150x45mm, stainless steel

1 SCISSORS, 14.5 cm, sharp-blunt



1451 SET, EAR-NOSE-THROAT, instruments

Basic instruments for simple ear, nose and throat procedures:

diagnostic examination, foreign body removal, packing for haemorrhage and tracheal dilatation during tracheotomy

1 (catheter, Eustachian, Hartmann)

1 CONNECTOR, olive-shaped

1 CASE, STERILIZING, 230x130x50mm, perforated w/textile filter

1 CATHETER, EUSTACHIAN, HARTMANN, D: 0.25x14cm, curved

1 DILATATOR, TRACHEAL, TROUSSEAU, 14 cm, two-bladed, adult

1 FORCEPS, EAR DRESSING, TILLEY, 14 cm

1 FORCEPS, EAR, HARTMANN, 1x2 teeth, serrated jaws

1 FORCEPS, NASAL DRESSING, GRUENWALD, 16cm, serrated jaws

1 MOUTH GAG, DOYEN-JANSEN, 10 cm, soft metal coated, child

1 SCISSORS, SEILER, 17 cm, nasal, angled to side

1 SPECULUM, NASAL, 15 cm, large

1 SPECULUM, NASAL, 15 cm, medium

1 SPECULUM, NASAL, 15 cm, small

1 SUCTION TUBE, FRAZIER-FERGUS,, CH6 x 19cm, angled, w/ con.



1452 SET, EMBRYOTOMY, instruments

- 1 CRANIOCLAST, BRAUN, 42 cm
- 1 HOOK, DECAPITATION, BRAUN, 31 cm
- 1 SCISSORS, DECAPITATION, DUBOIS, straight, blunt/blunt, 266 mm

1453 SET, EPISIOTOMY, instruments

- 1 DRAPE, SURGICAL, cotton, 75 x 90 cm, without hole, green
- 1 FORCEPS, HEMOSTATIC, ROCHESTER-PEAN, 16 cm, straight
- 1 FORCEPS, TISSUE, STANDARD, 20 cm, 1x2 teeth, straight
- 1 KIDNEY DISH, medium, 250x140x40mm, stainless steel
- 1 NEEDLE HOLDER, MAYO-HEGAR, 18 cm, standard
- 1 SCISSORS, EPISIOTOMY, BRAUN-STADLER, 21 cm, curved
- 1 SCISSORS, MAYO, 15.5 cm, straight

1454 SET, FINE SURGERY, complementary, instruments

Complete instrument set for delicate surgical procedures (tendon or nerve repair), plastic reconstructive surgery or tracheotomy

- 1 BOWL, ROUND, 100 ml, 80 x 35 mm, stainless steel
- 1 CASE, STERILIZING, 300x200x50mm, perforated w/textile filter
- 1 FORCEPS, ADSON, 12 cm, 1x2 teeth
- 1 FORCEPS, ADSON, 12 cm, serrated jaws
- 1 FORCEPS, GILLIES, 15 cm, 1x2 teeth
- 4 FORCEPS, HEMOSTATIC, CRILE, 14 cm, curved
- 8 FORCEPS, HEMOSTATIC, H-MOSQUITO, 12.5 cm, curved
- 8 FORCEPS, HEMOSTATIC, H-MOSQUITO, 12.5 cm, straight
- 2 FORCEPS, HEMOSTATIC, KOCHER, 14 cm/1x2 teeth, straight
- 1 FORCEPS, McINDOE, 15 cm, serrated
- 2 FORCEPS, SPONGE, FOERSTER, 24cm, serrated jaws, straight
- 2 FORCEPS, TISSUE, ALLIS-BABY, 14 cm / 3x4 teeth
- 2 FORCEPS, TISSUE, BABCOCK, 16 cm, 9 mm jaws, standard
- 5 FORCEPS, TOWEL CLAMP, BACKAUS, 13 cm
- 1 NEEDLE HOLDER, BABY-CRILE-WOOD, 15 cm
- 1 PROBE, 16 cm/diam. 1.5 mm, round double-ended
- 1 RETRACTOR, SELF-RET., WEITLANER, 13 cm, 3 x 4 blunt prongs
- 1 RETRACTOR, SENN-MILLER, 16 cm, double-ended, blunt prong
- 2 RETRACTOR, VOLKMANN, 22 cm, 3 sharp prongs, 10 mm curve

- 1 SCALPEL, HANDLE, No 3 (for blades 10/11/15)
- 1 SCISSORS, DISSECTING, METZENBAUM, 14 cm, curved
- 1 SCISSORS, MARTEL, 18 cm, curved, blunt
- 1 SCISSORS, MAYO, 17 cm, curved
- 1 SUCTION TUBE, FRAZIER, CH 12, 12.5 cm, angular



1455 SET, GASTRIC LAVAGE, instruments

Set composition:

- Funnel, approx 17 cm diameter,
- 4 different tubes, size: approx. CH 28, CH 32, CH 36, CH 40, autoclavable, length 150 cm, to fit on funnel
- measuring mug, 1,5 - 2 litres



1456 SET, GYNAECOLOGY (dilatation & curettage), instruments

Complete instrument set for dilatation and curettage

- 1 CASE, STERILIZING, 209x290x135mm, perforated w/textile filter
- 1 CURETTE, UTERINE, RECAMIER, 8 mm wide, rigid, blunt
- 1 CURETTE, UTERINE, RECAMIER, 8 mm wide, rigid, sharp
- 1 CURETTE, UTERINE, RECAMIER, 11 mm wide, rigid, blunt
- 1 CURETTE, UTERINE, RECAMIER, 11 mm wide, rigid, sharp
- 1 CURETTE, UTERINE, RECAMIER, 14 mm wide, rigid, blunt
- 1 CURETTE, UTERINE, RECAMIER, 14 mm wide, rigid, sharp
- 1 CURETTE, UTERINE, RECAMIER, 16 mm wide, rigid, blunt
- 1 CURETTE, UTERINE, RECAMIER, 20 mm wide, rigid, blunt
- 1 DILATATOR, UTERINE, HEGAR, double-ended, set of 8 dilators

- 1 FORCEPS, SEIZING, KELLY, OVARY, 32 cm, 18 mm jaws, curved
- 2 FORCEPS, SEIZING, POZZI, 25 cm, tenaculum, straight
- 2 FORCEPS, SPONGE, FOERSTER, 24cm, serrated jaws, straight
- 5 FORCEPS, TOWEL CLAMP, BACKKAUS, 13 cm
- 1 KIDNEY DISH, medium, 250x140x40mm, stainless steel
- 1 SCISSORS, MAYO, 17 cm, curved
- 1 SOUND, UTERINE, SIMS, 32 cm, rigid
- 1 SPECULUM, AUVARD, 240 x 75 x 38 mm, vaginal, with weight
- 1 SPECULUM-RETRACTOR, KALLMORGEN, 70 x 40 mm, vaginal
- 1 SPECULUM-RETRACTOR, KALLMORGEN, 90 x 40 mm, vaginal



1457 SET, LAPAROTOMY, (+ caesarian), instruments

- Complete instrument set for abdominal operations
- 1 BOWL, ROUND, 100 ml, 80 x 35 mm, stainless steel
 - 1 CASE, STERILIZING, 325x275x75mm, perforated w/textile filter
 - 1 FORCEPS, DRESSING, 14.5 cm, English pattern
 - 1 FORCEPS, DRESSING, STANDARD, 20 cm, straight
 - 10 FORCEPS, HEMOSTATIC, CRILE, 14 cm, curved
 - 1 FORCEPS, HEMOSTATIC, HEISS, 24 cm, curved, right-angle
 - 2 FORCEPS, HEMOSTATIC, R-OCHSNER, 16 cm/1x2 teeth, straight
 - 4 FORCEPS, HEMOSTATIC, ROCHESTER-PEAN, 20 cm, curved
 - 2 FORCEPS, HEMOSTATIC, ROCHESTER-PEAN, 26 cm, curved
 - 2 FORCEPS, HEMOSTATIC, ROCHESTER-PEAN, 26 cm, straight
 - 2 FORCEPS, INTESTINAL, KOCHER, 26 cm, elast. atraum., curved
 - 2 FORCEPS, INTESTINAL, KOCHER, 26 cm, elast. atraum., straight
 - 2 FORCEPS, SPONGE, FOERSTER, 24cm, serrated jaws, straight
 - 1 FORCEPS, TISSUE, 14.5 cm, 1x2 teeth, English pattern
 - 4 FORCEPS, TISSUE, ALLIS, 15 cm/4x5 teeth, standard
 - 4 FORCEPS, TISSUE, BABCOCK, 16 cm, 9 mm jaws, standard
 - 1 FORCEPS, TISSUE, STANDARD, 20 cm, 1x2 teeth, straight
 - 7 FORCEPS, TOWEL CLAMP, BACKKAUS, 13 cm
 - 4 FORCEPS-CLAMP, UTERINE, GREEN-ARMYTAGE, 22 cm x 13 mm
 - 2 KIDNEY DISH, large, 275x150x45mm, stainless steel
 - 1 NEEDLE HOLDER, MAYO-HEGAR, 15 cm, standard
 - 1 NEEDLE HOLDER, MAYO-HEGAR, 18 cm, standard
 - 1 NEEDLE HOLDER, MAYO-HEGAR, 23 cm, standard
 - 1 RETRACTOR, ABDOMINAL, BALFOUR, standard, complete

- 1 RETRACTOR, FRISCH, 25.5 cm, 75 x 45 mm
- 2 RETRACTOR, ROUX, complete set (sizes 1, 2, 3)
- 1 RETRACTOR/SPATULA, DAEVER, 30cm x 38mm, flexible
- 1 SCALPEL, HANDLE, No 3 (for blades 10/11/15)
- 1 SCALPEL, HANDLE, No 4 (for blades 20)
- 1 SCISSORS, DISSECTING, METZENBAUM, 14 cm, curved
- 1 SCISSORS, DISSECTING, METZENBAUM, 20 cm, curved
- 1 SCISSORS, MAYO, 17 cm, curved
- 1 SUCTION TUBE, POOLE, 22 cm/diam. 8 mm, curved



1458 SET, OMPHALOTOMY, instruments

- Instrument set for cutting the umbilical cord
- 2 FORCEPS, HEMOSTATIC, KOCHER, 14 cm/1x2 teeth, straight
 - 1 SCISSORS, MAYO, 15.5 cm, straight

1459 SET, PLASTER CASTS REMOVAL, instruments

- Manual instruments for removal of Plaster of Paris casts
- 1 BREAKER, PLASTER CAST, WOLFF-BOEHLER, 18 cm
 - 1 KNIFE, PLASTER, ESMACH, 18 cm
 - 1 SCISSORS, PLASTER SHEARS, BRUNS, 24cm
 - 1 SCISSORS, PLASTER SHEARS, STILLE, 37 cm, reinforced blade
 - 1 SPREADER, PLASTER, HENNIG, 27 cm



1460 SET, SKELETAL TRACTION, instruments + 10 bows

Instruments and material for applying skeletal traction:

7 tibial + 3 olecranon or calcaneal

Manual application of Steinmann pins

1 BIT, DRILL, 3.2 mm, Jacobs chuck, 180/165 mm

7 BOW, EXTENSION, BOEHLER, 11 x 21 cm

3 BOW, EXTENSION, BOEHLER, 9 x 16 cm

1 CHUCK, UNIVERSAL (3-jaw) with T-handle + locking device

3 NAIL, EXTENSION, STEINMANN, 150 x 4 mm, trocar point

7 NAIL, EXTENSION, STEINMANN, 210 x 4 mm, trocar point

2 ROPE, TRACTION, 3mm x 15m, bow, extension, Boehler



1461 SET, SKIN GRAFT, instruments

Complementary set for split skin grafting.

5 (dermatome Humby), BLADE

2 (dermatome Schink) PLATE, for skin holding

1 BOARD, 20 x 15 cm hard wood or synthetic material, sterilizable

1 BOWL, ROUND, 100 ml, 80 x 35 mm, stainless steel

1 CASE, STERILIZING, 300x200x50mm, perforated w/textile filter

1 DERMATOME, HUMBY

1 FORCEPS, DRESSING, 14.5 cm, English pattern

5 FORCEPS, TOWEL CLAMP, BACKKAUS, 13 cm

1 SCISSORS, DISSECTING, METZENBAUM, 14 cm, curved



1462 SET, STERILE OBJECT HANDLING, instruments

1 FORCEPS, STERILIZING, CHEATLE, 27 cm
1 JAR FOR FORCEPS, 75 x 175 mm, without lid, stainless steel

1463 SET, SURGICAL NEEDLES

Set of most common used spring eye needles
Reuseable
300-series
Stainless steel
Unsterile
Packaging: in stainless steel needle case (round or square)

1464 SET, THORACOTOMY, complementary, instruments

Complementary instruments for chest operations
1 CASE, STERILIZING, 580x280x100mm, perforated w/textile filter
1 CONTRACTOR, RIB, BAILEY, 17cm
1 CUTTER, STERNUM, SCHUMACHER, 22cm
2 FORCEPS, TISSUE, DUVAL, 23cm, atraum., triangular
1 RASPATORY, FARABEU, 150x13mm, light curved, sharp
1 RASPATORY, RIB, DOYEN, 17cm, left
1 RASPATORY, RIB, DOYEN, 17cm, right
1 RETRACTOR, LUNG, ALLISON, 270x40mm
1 SHEAR, RIB, GIERTZ, 25cm
1 SPREADER, RIB, FINOCCHIETTO, medium, blade, 65x45mm



1465 SET, URETHRAL SOUNDS, instruments

Complete set for dilatation of urethral stenosis
1 BOWL, ROUND, 100 ml, 80 x 35 mm, stainless steel
1 CASE, STERILIZING, 325x275x50mm, perforated w/textile filter
1 SOUND, URETHRAL, CH 07, pvc, 37cm, olive tip, red, straight
1 SOUND, URETHRAL, CH 08, pvc, 37cm, olive tip, red, straight
1 SOUND, URETHRAL, CH 09, pvc, 37cm, olive tip, red, straight
1 SOUND, URETHRAL, CH 10, pvc, 37cm, olive tip, red, straight
1 SOUND, URETHRAL, CH 11, pvc, 37cm, olive tip, red, straight
1 SOUND, URETHRAL, CH 12, pvc, 37cm, olive tip, red, straight

1 SOUND, URETHRAL, CH 13, pvc, 37cm, olive tip, red, straight
1 SOUND, URETHRAL, CH 14, pvc, 37cm, olive tip, red, straight
1 SOUND, URETHRAL, CH 15, pvc, 37cm, olive tip, red, straight
1 SOUND, URETHRAL, CH 16, pvc, 37cm, olive tip, red, straight
1 SOUND, URETHRAL, CH 17, pvc, 37cm, olive tip, red, straight
1 SOUND, URETHRAL, DITTEL, CH 06, 35 cm, curved
1 SOUND, URETHRAL, DITTEL, CH 08, 35 cm, curved
1 SOUND, URETHRAL, DITTEL, CH 10, 35 cm, curved
1 SOUND, URETHRAL, DITTEL, CH 12, 35 cm, curved
1 SOUND, URETHRAL, DITTEL, CH 14, 35 cm, curved
1 SOUND, URETHRAL, DITTEL, CH 16, 35 cm, curved
1 SOUND, URETHRAL, DITTEL, CH 18, 35 cm, curved
1 SOUND, URETHRAL, DITTEL, CH 20, 35 cm, curved
1 SOUND, URETHRAL, DITTEL, CH 22, 35 cm, curved
1 SOUND, URETHRAL, DITTEL, CH 24, 35 cm, curved
1 SOUND, URETHRAL, DITTEL, CH 26, 35 cm, curved
1 SOUND, URETHRAL, DITTEL, CH 28, 35 cm, curved
1 SOUND, URETHRAL, DITTEL, CH 30, 35 cm, curved
1 SOUND, URETHRAL, DITTEL, CH 32, 35 cm, curved
1 SOUND, URETHRAL, DITTEL, CH 34, 35 cm, curved
1 SOUND, URETHRAL, DITTEL, CH 36, 35 cm, curved



1466 SET, WOUND EXCISION, instruments

Complete instrument set for wound excision (débridement) or other basic but major procedures, such as tracheotomy

Can be used as complementary basic set together with specialized instrument sets for more specific surgery:

bone surgery and wiring, craniotomy, ENT procedures, external fixation, skeletal traction, vascular procedures

1 BOWL, ROUND, 100 ml, 80 x 35 mm, stainless steel
1 CASE, STERILIZING, 300x200x50mm, perforated w/textile filter
1 CURETTE, BONE, VOLKMANN, 22 cm, double-ended, fig. 3 and 5
1 FORCEPS, DRESSING, 14.5 cm, English pattern
8 FORCEPS, HEMOSTATIC, CRILE, 14 cm, curved
3 FORCEPS, HEMOSTATIC, R-OCHSNER, 16 cm/1x2 teeth, straight
2 FORCEPS, SPONGE, FOERSTER, 24cm, serrated jaws, straight
1 FORCEPS, TISSUE, 14.5 cm, 1x2 teeth, English pattern
2 FORCEPS, TISSUE, ALLIS, 15 cm/4x5 teeth, standard
5 FORCEPS, TOWEL CLAMP, BACKHAUS, 13 cm
1 KIDNEY DISH, large, 275x150x45mm, stainless steel

- 1 NEEDLE HOLDER, MAYO-HEGAR, 15 cm, standard
- 1 NEEDLE HOLDER, MAYO-HEGAR, 18 cm, standard
- 2 RETRACTOR, LANGENBECK, 21 cm, 13 x 42 mm
- 1 RETRACTOR, SELF-RET., WEITLANER, 16 cm, 3 x 4 blunt prongs
- 1 RONGEUR, BONE, LUER, 18 cm x 10 mm, heavy pattern
- 1 SCALPEL, HANDLE, No 4 (for blades 20)
- 1 SCISSORS, DISSECTING, METZENBAUM, 14 cm, curved
- 1 SCISSORS, DISSECTING, METZENBAUM, 18 cm, curved
- 1 SCISSORS, MAYO, 17 cm, curved



1468 SHEET, COTTON, sterile wrapping, 75 x 75 cm

Material: 100% cotton or 50% cotton and 50% polyester
Reusable woven fabrics

Designation: 100% cotton cretonne fabric

- Number of threads/cm: warp: 24, weft: 24
- Metric count: warp: 28, weft: 28
- Weight per m2: 180 g

Polyester/ cotton:

Designation: Woven cotton 50% cotton / 50% polyester fabric, heat set

- Number of threads/cm: warp: 24, weft: 22
- Metric count: warp: 28, weft: 28
- Weight per m2: 175g

Both woven fabric material are suitable for normal washing, withstand boiling & autoclaving and are resistant to chlorine 5%

Colour: green

4 hemmed borders

Non-sterile multiple use

Packaging: protected in a plastic bag, single or multiple unit

Other requirements: meets G1 DIN 61621

1469 SHEET, COTTON, sterile wrapping, 100 x 100 cm

Material: 100% cotton or 50% cotton and 50% polyester
Reusable woven fabrics

Designation: 100% cotton cretonne fabric

- Number of threads/cm: warp: 24, weft: 24
- Metric count: warp: 28, weft: 28
- Weight per m2: 180 g

Polyester/ cotton:

Designation: Woven cotton 50% cotton / 50% polyester fabric, heat set

- Number of threads/cm: warp: 24, weft: 22
- Metric count: warp: 28, weft: 28
- Weight per m2: 175g

Both woven fabric material are suitable for normal washing, withstand boiling & autoclaving and are resistant to chlorine 5%

Colour: green

4 hemmed borders

Non-sterile multiple use

Packaging: protected in a plastic bag, single or multiple unit

Other requirements: meets G1 DIN 61621

1470 SHEET, COTTON, sterile wrapping, 120 x 120 cm

Material: 100% cotton or 50% cotton and 50% polyester

Reusable woven fabrics

Designation: 100% cotton cretonne fabric

- Number of threads/cm: warp: 24, weft: 24
- Metric count: warp: 28, weft: 28
- Weight per m2: 180 g

Polyester/ cotton:

Designation: Woven cotton 50% cotton / 50% polyester fabric, heat set

- Number of threads/cm: warp: 24, weft: 22
- Metric count: warp: 28, weft: 28
- Weight per m2: 175g

Both woven fabric material are suitable for normal washing, withstand boiling & autoclaving and are resistant to chlorine 5%

Colour: green

4 hemmed borders

Non-sterile multiple use

Packaging: protected in a plastic bag, single or multiple unit

Other requirements: meets G1 DIN 61621

1471 SHEET, PE, 150 micron, roll of 50m, 60 cm width

Used for covering OT table

Material: PE transparent

Designed for heavy duty

Unsterile

1472 SHELVES, plastic, approx 90 x 50 x 180 cm

knock-down construction

lightweight

4-5 shelves, held by 4 plastic poles



1473 SHOE, CLOG, surg., antistatic, wash. 85C, pair, size 8 (38)

Intended for people working in areas where the infectious risk is high
Used to limit the risk of infection related to splashes of infectious substances on the feet and to avoid soiling the floor with shoes worn outside

Material: water proof, antistatic polyurethane

- Rapid drying
- One piece moulded
- Non-perforated
- Light, flexible, stable, non-slipping (even on humid floor), un-deformable, silent
- Fits good at the foot, with or without back-strap
- Can be washed and disinfected

Non sterile, multiple use



1474 SHOE, CLOG, surg., antistatic, wash. 85C, pair, size 9 (40)

Intended for people working in areas where the infectious risk is high
Used to limit the risk of infection related to splashes of infectious substances on the feet and to avoid soiling the floor with shoes worn outside

Material: water proof, antistatic polyurethane

- Rapid drying
- One piece moulded
- Non-perforated
- Light, flexible, stable, non-slipping (even on humid floor), un-deformable, silent
- Fits good at the foot, with or without back-strap
- Can be washed and disinfected

Non sterile, multiple use

1475 SHOE, CLOG, surg., antistatic, wash. 85C, pair, size 11 (44)

Intended for people working in areas where the infectious risk is high
Used to limit the risk of infection related to splashes of infectious substances on the feet and to avoid soiling the floor with shoes worn outside

Material: water proof, antistatic polyurethane

- Rapid drying
- One piece moulded
- Non-perforated
- Light, flexible, stable, non-slipping (even on humid floor), un-deformable, silent
- Fits good at the foot, with or without back-strap
- Can be washed and disinfected

Non sterile, multiple use

1476 SLIDE BOX, for 100 slides

Slide box designed for safe storage and transport of slides

Capacity: 100 slides measuring 76 x 26 mm

Lock numbered slots with index sheets

Material: plastic

To be used with: SLIDE, 76 x 26 mm, for microscopy
SLIDE, 76 x 26 mm, for microscopy with frosted ends



1477 SLIDE, 76 x 26 mm, for microscopy

Glass slide to analyse stained preparations of different specimen (blood slides for malaria)

Washed, with any grease removed

No frosted ends

Washable and re-usable

Packaging: protective

To be used with: SLIDE BOX, for 100 slides

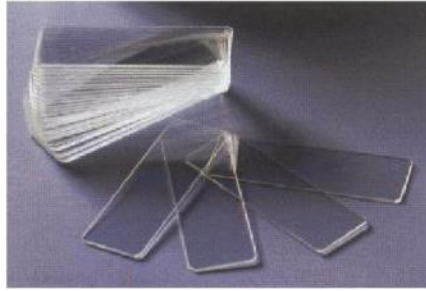

1478 SLIDE, 76 x 26 mm, for microscopy with frosted ends

Glass slide to analyse stained preparations of different specimen (blood slides for malaria)
Washed, with any grease removed
Frosted ends
Washable and re-usable
Packaging: protective
To be used with: SLIDE BOX, for 100 slides

1479 SLIPPERS, bathroom type, plastic, pair, size 40



1480 SOAP DISPENSER, 1000 ml, incl. support for tent pole

Soap dispenser designed to hold 1000 ml soap bottles
Material: Strong plastic or stainless steel
The dispenser should have a fixing system for the tent pole
To be supplied with: empty 1000 ml plastic bottle for refill

1481 SOAP, body soap, 100g, piece

Toilet soap in bar, not harmful for the skin, from vegetable or animal (non-pork) fat
Product must be fit for human utilisation and be of sound, fair and marketable quality
Homogeneous colour and aspect
Without any disagreeable odours and flavours
Fatty acid: minimum 70 %
Moisture: maximum 20 % at time of packing
NaOH content: maximum 0.2 %
NaCl content: maximum 0.5 %

1482 SOAP, LIQUID, 500 ml, in dispenser

Product must be fit for human utilisation and be of sound, fair and marketable quality
None skin-irritating effect

Packing: Polyethylene bottle of 500 ml net, push-down dispenser in screw cap
No leakage under the pressure of two stacked pallets



1483 SODIUM METABISULFITE, powder, 100 g, bottle

Sodium metabisulfite powder is used to prepare the aqueous sodium disulfite solution (to reduce the oxygen from the wet preparation of the sickle cell test)

Dangerous goods:

- Symbol: GHS05, GHS07
- Hazard statements: H302-H318
- Precautionary statements: P280-P305 + P351 + P338
- Supplemental hazard statements: EUH031
- Personal Protective Equipment: dust mask type N95 (US), eye shields, gloves
- Hazard code: Xn
- Risk statements: 22-31-41
- Safety statements: 26-39-46

Storage: protect from humidity

Packing: 100 g plastic bottle with DG labeling (according to IATA regulations)

Other requirements: meets analytical specification of Ph. Eur., BP, NF, FCC, E223

1484 SPATULA, WEIGHING, stainless steel, L 120 mm

Instrument with one spoon-shaped end and one spatula-shaped end to handle powders to be weighed

Material: stainless steel

Length: 120 mm



1485 SPECIMEN CUP, 30 ml, plastic, with spoon cover, for stool

Transparent container (22 x 62 mm) with screw spoon stopper used for stool samples

Material: Polystyrene crystal

Non sterile, non graduated, disposable

1486 SPECIMEN CUP, 125 ml, plastic, with cover, for sputum

Container with hermetic screw cap used for sputum samples

Material: Polypropylene

Non sterile, graduated, disposable



1487 SPECULUM, CUSCO, 100 x 25-27 mm, vaginal, medium, cone shape

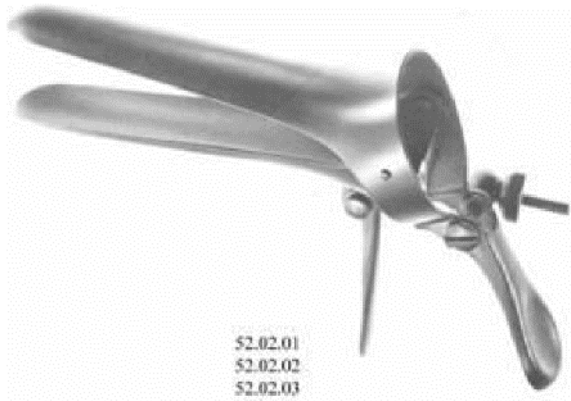

1488 SPECULUM, CUSCO, 100 x 27-30 mm, vaginal, large, cone shape

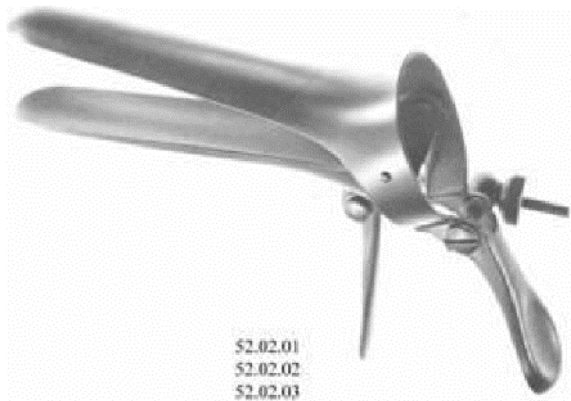

1489 SPECULUM-RETRACTOR, KALLMORGEN, 70 x 40 mm, vaginal

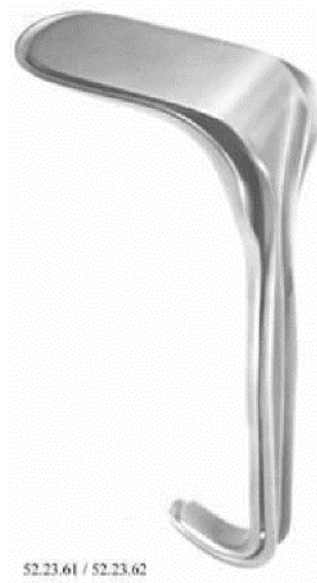

1490 SPECULUM-RETRACTOR, KALLMORGEN, 90 x 40 mm, vaginal

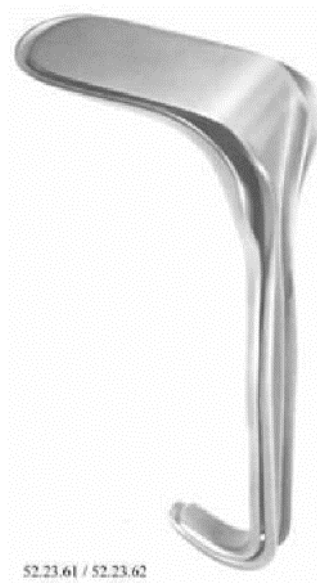

1491 SPHYGMOMANOMETER, ANEROID, adult with 1cuff 14x54.5 cm

Instrument used to measure indirect arterial blood pressure, composed of an aneroid pressure gauge connected to an inflatable cuff wrapped around the arm and secured by Velcro tape

Adult, palm style, sphygmomanometer with one tube

Aneroid pressure gauge with air pressure-release valve

Diameter: 63 mm

Linear scale graduated from 0-300 mmHg, easy-to-read

Maximum error throughout range ± 3 mmHg

Diaphragm membrane: can withstand overpressures of up to 600 mmHg

Material: Hardened copper-beryllium

Handle : stainless steel
Tube connector and valve: nickel plated
Rubber bulb with palm handle
Mounted with a one-way valve to prevent inadvertent leak of pressure while there is an adjustable screw valve for the operator to allow the pressure in the system to drop in a controlled manner
Washable at 30°C
Made of non-deformable material with Velcro fastening so to enable tight adjustment around the arm
Cuff size: Length 54.5 cm; width 14 cm
Inside the cuff is an inflatable bladder which has to be air-tight
Size: 22 cm x 10 cm
Connecting tube in rubber
Packaging: in a vinyl or leatherette zipper case
Other requirements: conform to EN 1060-1 -1A -2002; EN 1060-2-1995



1492 SPHYGMOMANOMETER, ANEROID, baby/child w/3 cuffs 5 /7/10cm

Instrument used to measure indirect arterial blood pressure, composed of an aneroid pressure gauge connected to an inflatable cuff, wrapped around the arm and secured by Velcro tape. Specifications Baby/child, palm style, sphygmomanometer with one tube
Aneroid pressure gauge with air pressure-release valve, diameter: 49 mm
Linear scale graduated from 0-300 mmHg, easy-to-read
Maximum error throughout range ± 3 mmHg
Diaphragm membrane: can withstand overpressures of up to 600 mmHg
Material: Hardened copper-beryllium
Handle in stainless steel
Tube connector and valve: nickel plated
Rubber bulb with palm handle
Mounted with a one-way valve to prevent inadvertent leak of pressure while there is an adjustable screw valve for the operator to allow the pressure in the system to drop in a controlled manner
Cuff sizes:

- New born Length 15.5 cm, width 5 cm
- Baby/infant Length 23 cm, width 7.2 cm
- Child Length 35.5 cm, width 10 cm

Cuffs should be interchangeable
Washable at 30°C
Made of non-deformable material with Velcro fastening so to enable tight adjustment around the arm
Inside the cuff is an inflatable rubber bladder which has to be air-tight

Connecting tube in rubber.

Packaging: in a vinyl or leatherette zipper case

Other requirements: conform to EN 1060-1 -1A -2002; EN 1060-2-1995



1493 SPIRIT LAMP, 100ml, glass

The spirit lamp is used to fix smear over a flame

Material: glass or stainless steel

Flat conical form with ground cap, with wick and socket

Capacity 100 ml

Height 100 mm

Ø bottom: 75 mm

Packaging: protective



1494 SPLINT, BOHLER-BRAUN, 40 - 60 cm, size 1, foldable

Enabling traction by weights and pulleys, to immobilize a broken tibia or femur, to support an injured leg in the correct position

Components:

- Adjustable splint made up of metal tubes that slide into one another
- Two pulleys, one horizontal and one vertical

Material: stainless steel, plastic coated

Adjustable splint that can be dismantled into its component parts

Indicative dimensions:

Splint open:

- length: 40-60 cm (adjustable to need)

- width: 38 cm
 - height: 55 cm
- Splint folded:
- 42 cm x 38 cm x 5 cm
 - Weight: 2.5 kg
- Supplied with assembly diagram
Packaging: dismantled/folded
The following information must appear on the packaging:
- designation of item
 - name and address of supplier (manufacturer)
- To be supplied with:** assembly diagram
Other requirements: should conform to ISO standard

1495 SPLINT, BOHLER-BRAUN, 60 - 80 cm, size 2, foldable

Enabling traction by weights and pulleys, to immobilize a broken tibia or femur, to support an injured leg in the correct position

Components:

- Adjustable splint made up of metal tubes that slide into one another
- Two pulleys, one horizontal and one vertical

Material: stainless steel, plastic coated

Adjustable splint that can be dismantled into its component parts

Indicative dimensions:

Splint open:

- length: 60-80 cm (adjustable to need)
- width: 38 cm
- height: 55 cm

Splint folded:

- 62 cm x 38 cm x 5 cm
- Weight: 3.4 kg

Supplied with assembly diagram

Packaging: dismantled/folded

The following information must appear on the packaging:

- designation of item
- name and address of supplier (manufacturer)

To be supplied with: assembly diagram

Other requirements: should conform to ISO standard

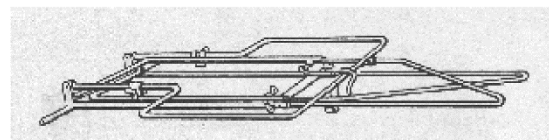
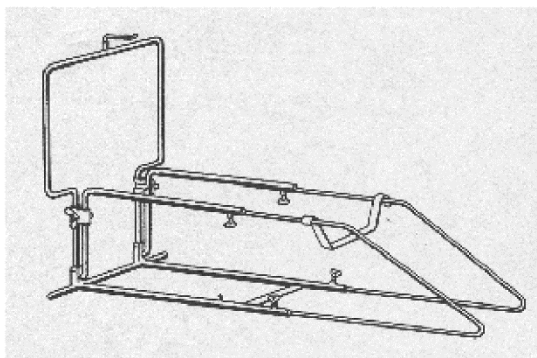

1496 SPLINT, FINGER, aluminium, 25 mm x 5 m

1497 SPLINT, KRAMER, 10 cm x 100 cm

Foldable metal lattice used for temporarily immobilizing a limb
Material: Epoxy-coated steel
Small lattice with cross-wires spaced 2 cm apart, the proximal end having rounded corners
Malleable to the desired angle
Dimensions:
- Width: 10 cm
- Length: 100 cm
Other requirements: should conform to ISO standard

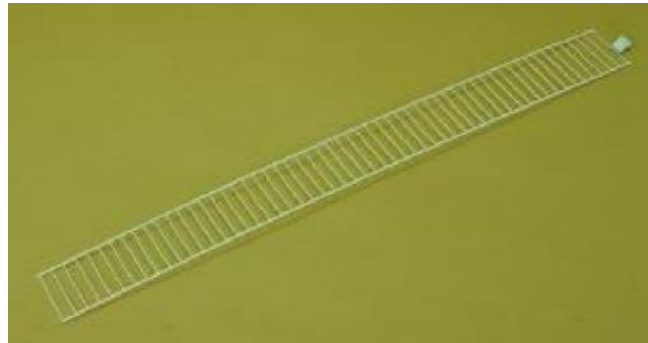

1498 SPLINT, KRAMER, 15 cm x 100 cm

Foldable metal lattice used for temporarily immobilizing a limb
Material: Epoxy-coated steel
Small lattice with cross-wires spaced 2 cm apart, the proximal end having rounded corners
Malleable to the desired angle
Dimensions:
- Width: 15 cm
- Length: 100 cm
Other requirements: should conform to ISO standard

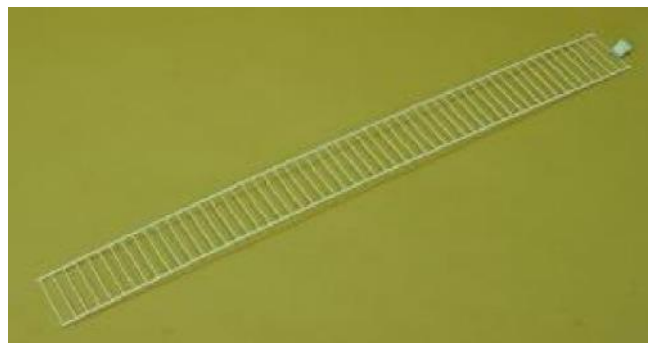

1499 STAINING BLOCK, BLACK GLASS WITH HALF ROUND CAVITY & COVER 40 x 40 mm

Used to keep the Turk solution to dilute the blood for WBC count or to keep Pandy reagent to measure protein of CSF
Pressed glass with half round cavity \varnothing 32 mm with cover plate 40 x 40 mm
Packaging: protective packaging

1500 STAINING BLOCK, CLEAR GLASS WITH HALF ROUND CAVITY + COVER 40 x 40 mm

Used to keep the Turk solution to dilute the blood for WBC count or to keep Pandy reagent to measure protein of CSF
Pressed glass with half round cavity Ø 32 mm with cover plate 40 x 40 mm
Packaging: protective packaging

1501 STAINING DISH, glass

This instrument dish glass can be used as staining glass bowl
Like 'Assistent Nr 2900'
A staining frame can be fixed on the glass dish
Outside measurements: 220 mm x 150 mm x 55 mm (L x W x D)
Weight: 1.22 kg
To be used with: STAINING FRAME, extendable



2900

1502 STAINING FRAME, extendable

Like 'Assistent Nr1198'
Material: stainless steel
The slides on it can lay straight or angular
Staining frame is moveable
Fixable on a glass instrument dish (220 mm x 150 mm x 55 mm)
Weight: 250 g
Minimal dimension: 160 mm x 70 mm x 130 mm (L x W x D)
Max. length: 270 mm
To be used with: STAINING DISH, glass



1198

1503 STAINING TROUGH RACK, with handle, for 10 slides

Staining trough with cover is used to stain slides
Material: stainless steel
For 10 slides
With handle

To be used with: STAINING TROUGH, with cover, glass

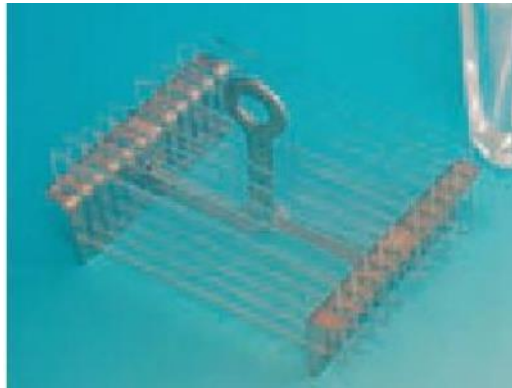

1504 STAINING TROUGH, with cover, glass

Staining trough with cover is used to stain slides

Size (outside measurements):

- Length 96 mm
- Width: 72 mm
- Depth: 60 mm

To be used with: STAINING TROUGH RACK, with handle for 10 slides

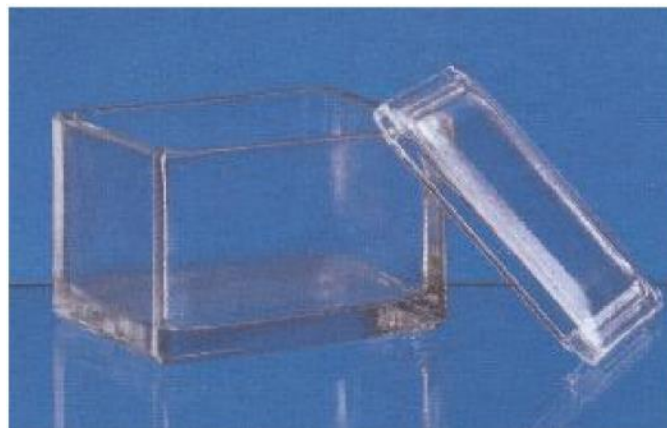

1505 STAND, for cross-matching tubes, hole diam. 12 mm

Rack which holds several cross matching tubes

Material: plastic

Dismantable

Autoclavable

To be used with: TUBE FOR CROSS-MATCH, GLASS, 12 x 75 mm, 4 ml

1506 STAND, FOR LOOP HOLDER

Stand for handles with wire loop

Material: wood

To be used with: LOOP HOLDER, Kolle (240 mm) aluminium

1507 STAND, for pipettes

Stand which holds pipettes in a vertical position

Material: plastic



1508 STAND, for test tubes diam. 16 mm, plastic

Rack to hold several test tubes in a vertical position

Capacity min 48 tubes

Dismantable

Autoclavable

To be used with: TEST TUBE, for Benedict test glass, 160x16mm round bottom rimless

1509 STAND, INFUSIONS, knock-down construction

Height: adjustable to 1200-2200 mm

Wide stance base with castors

Double hook rod includes positive stop to avoid disengagement

Material:

- Base rod and locking device: iron with epoxy finish
- Double hook and rod: stainless steel

1510 STERILIZER STEAM PENETRATION TEST, Bowie and Dick

Steam penetration test for sterilization by steam

Disposable

Other requirements: meets EN 867-4

1511 STETHOSCOPE, duplex, adult, (dual-head chestpiece)

For auscultation (chest, abdomen, blood pressure, etc)
Binaural stethoscope (for adult and paediatric use) with pivoting double chest piece
Sensitivity:
- 3.2 dB in a range from 50 to 500 Hz for cardiology
- 8.1 dB in a range from 600 Hz to 1,500 Hz for pneumology
Overall length +/- 77 cm
Pivoting chest piece with two cups:
One side is flat/large and the other is conically-shaped (bell) /small
Size:
- Adult approx 43 mm
- Paediatric approx 28 mm
Material: aluminium or stainless steel or chrome plated brass
All-frequency diaphragms in high-resolution epoxy glass
Y tube with large diameter: 10 mm
Material treated rubber (vinyl)
Arms with spring treated to give constant springiness and maximum reliability and comfort.
Material: stainless steel
Screw-on changeable earpieces. Material: plastic
Packaging: in a box
To be supplied with: 1 spare diaphragm, (large and small)
1 pair of spare earpieces



1512 STETHOSCOPE, duplex, neonatal, (dual-head chestpiece)

For auscultation (chest, abdomen, blood pressure, etc)
Binaural stethoscope, neonatal, with pivoting double chest piece
Sensitivity:
- 20 Hz - 100 Hz max. 1.2 dB at 55Hz
- 100 Hz - 1,500 Hz max. 8.5 dB at 300 Hz
Overall length +/- 76 cm
Pivoting chest piece with two cups
One side is flat/large and the other is conically-shaped (bell) /small
Size: Flat approx 28 mm / bell approx 21 mm
Material: aluminium or stainless steel or chrome plated brass
All-frequency diaphragms in high-resolution epoxy glass
Y tube with large diameter: 10 mm
Material: treated rubber (vinyl)
Arms with spring treated to give constant springiness and maximum reliability and comfort
Material: stainless steel
Screw-on changeable earpieces
Material: plastic

Packaging: in a box

To be supplied with: 1 spare diaphragm, (large and small)
1 pair of spare earpieces

1513 STETHOSCOPE, fetal, Pinard

Instrument for listening to foetal heart

Overall length +/- 15 cm

Instrument may be in either single or two pieces, with a foot that unscrews

Material: aluminium, plastic or wood



1514 STETHOSCOPE, one cup

For the measurement of arterial blood pressure with sphygmomanometer

Binaural stethoscope, with single chest piece

Sensitivity:

- 3.8 dB in a range of 50 to 500 Hz
- 100 Hz - 1,500 Hz max. 8.5 dB at 300 Hz

Overall length: +/- 76 cm

Material:

- Housing: aluminium alloy
- High resolution diaphragm: epoxy glass
- Y tube: treated rubber (vinyl)
- Arms: stainless steel
- Earpieces: plastic

Single chest piece:

- With diaphragm and ring
- One side is flat/large and the other is conically-shaped (bell) /small
- Size: approx 43 mm

Y tube impervious to outside noises, with large diameter (10 mm)

Arms with spring treated to give constant springiness and maximum reliability and comfort

Screw-on changeable earpieces

Packaging: in plastic or cardboard box

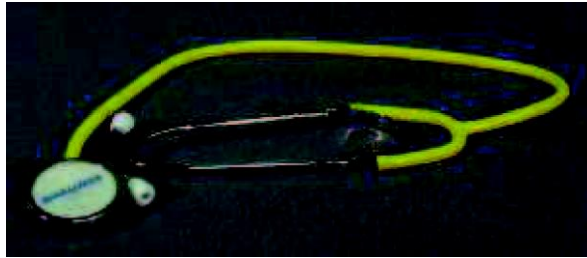

1516 STOOL, FOR O.T., with castors, h. 44-64 cm, stainless steel

Stainless steel base
Plywood seat with 30 mm padded conductive cushion
Rotates 360 degrees
Height adjustable approx from 400 to 650 mm
On 5 anti-static swivel castors
Knock down construction



1517 STOPPER, diameter 16 mm, for tubes

Used to close tubes
Material: polyethylene
With lamellae
To be used with: TUBE, glass, 100 x 16 mm, round bottom

1518 STOVE, electrical plate 18cm, 1500W, 230V, table top

Material:
- Housing in stainless steel or high quality enameled steel
- Hot plate in cast iron
Approx. 180 mm diameter
Sturdy construction, solid top, easy to clean
Maximum surface temperature 500°C
With regulator switch and indicator light
Cable: length (2 m) with European plug (with earth connection)
Power 1.5 kW, 240 V, 50Hz



1519 STRETCHER Undercarriage, large wheels

Undercarriage with big wheels (diameter approx 60 cm)
Height: approx 90 cm

To be used with: STRETCHER, foldable in width and length



1520 STRETCHER, foldable in width and length

Stretcher with feet, can be placed on the floor, extractable handles
Material:

- Frame tube / feet: anti-corrosive and anodised aluminium
- Stretcher cover: tarpaulin material, X-Ray translucent

Overall dimension: approx 220 x 570 x 15 cm

Patient area approx 190 cm long

Overall dimension folded up: approx. 192 x 15 x 15 cm (carry handle pushed in)

Weight approx: 8 kg

Frame: Seamless aluminium structure made of tube (pole) square of round; diameter approx. 30 x 1.5 mm with non-slip and insulated carrying handles

Stretcher covers: washable, disinfectable fabric, no absorption of moisture, decay resistant, easy to maintain

4 feet; with possibility to attach detachable supports

Carrying capacity up to approx 150 kg

Packaging: Individually packed, in knockdown version, assembling instruction included

The following information must appear on the packaging:

- designation of item, CE marking name and address of supplier (manufacturer)

Other requirements: Manufactured in accordance with ISO EN 13024

Resistant to corrosion (suitable for tropical environment) and decontamination (chlorine solution)

Resistant waterproof, washable, flame retardant



1521 STRETCHER, stand, foldable

To be used with: STRETCHER, foldable in width and length according to DIN 13024

1522 SUCTION UNIT, electric, 1 bottle, 1 ltr, autoclavable

This suction unit is foreseen to be used in anaesthesia or intensive care

Components:

- 1 Suction unit
- 1 Collector bottle with cover
- 1 Tube
- 1 Bacterial filter

Suction unit:

- Vacuum capacity: approx 20 L/min
- Maximum vacuum: 75 kPa / 600 mmHg

Collector bottle:

- 1-2 litre, autoclavable
- Bottle with overflow security switch.
- Cover for collector bottle with overflow and connector to patient with tranconical form diam. 6 x 10 mm

Tube:

- Silicone, diam. 12 x 7 mm, 25 cm long with connector straight and curved

Bacterial filter:

- Dimensions approx: 38 x 17 x 28.5 cm
- Weight: approx 3.5 kg

Other requirements: conform to EN ISO 60601-1, EN60601-1-2, EN 10079-1 and EN 7779 for noise

To be supplied with: Spare parts:

- 1 Bottle, 1 litre, autoclavable
- 3 Bacterial filter



1523 SUCTION UNIT, electric, permanent suction mode for thoracic drainage

When using a suction machine for thoracic drainage, the maximum vacuum recommended is 5 kPa

Vacuum regulator with safety lock-function

Max flow: 8 l/min

Vacuum range: up to 9 kPa / 68 mmHg

Battery powered

Other requirements: ISO 9001
ISO 13485
CE (93/42/EEC) Class II a



1524 SUCTION UNIT, foot operated, 600 ml

The suction pump is used for pharyngeal or tracheal aspiration in emergency situations

Like Ambu® Twin Pump

Double acting piston pump with high suction performance due to combination of large air

flow and high vacuum

Seesaw movement of the pedal operates the pump, can be operated either by foot or hand

Made of high strength long life materials, corrosion and rustproof

All parts are autoclavable at 121°C

Maximum free air flow: approx. 70 litres/min

Maximum vacuum: approx. -800 mbar (-80 kPa / 600 mmHg)

Materials:

- Seals, O-rings and valve diaphragms: silicone rubber
- Pistonrings: Teflon
- Container with 600 ml fluid capacity: transparent plastic (polycarbonate)
- Suction tube 135 cm, diameter 10 mm, silicone rubber, with a combination suction tip and angled connector

Operating temperature range: -20°C to +50°C

Storage conditions: temperature: -40°C to +70°C



1525 SUCTION UNIT, surgical, electric, 2 bottles 5 ltr, complete

Compact electrical surgical suction unit, on trolley with two 5 litre collection jars/bottles and overflow security system

Components:

- 1 Suction pump
- 2 Collection jars
- 1 Bacterial filter
- 1 Suction tube
- 1 Trolley

Suction pump:

- Suction capacity 40 +/-4 L/min
- Maximum vacuum up to -91 kPa (-910 mbar / 735 mmHg), with adjustable vacuum control

Operation conditions:

- Operation time 24 hours (8 hours of continuous operation without interruption)
- Temperature +5°C to + 35°C /humidity: 20 up to 80% /non-condensing air pressure 70 kPa to 106kPa

Collection jars/bottle:

- 5l with 100ml scale graduation
- Material polysulphone, autoclavable up to 136°C, 3 bar, maximum 20 min

Bacterial filter:

- Hydrophobic, disposable, should be replaced once a day

Suction tube:

- Size: Inner diameter 6 mm; length 2 m
- Material: silicone, autoclavable

Trolley:

- 4 castors: diameter: 75 mm, pedestal open fork
- Easy to clean

Easy control vacuum meter

Turning knob for vacuum adjustment

Other requirements: conform to EN ISO 60601-1, EN60601-1-2, EN10079-1, and EN7779 for noise

To be supplied with: Spare parts
60 anti-bacterial filters
2 spare suction tube, diam. 6 mm, 2 m, autoclavable
1 bottle 5 ltr, autoclavable
2 fuses

1527 SURGICAL SUTURE, absorbable, liver, collagen band, 60 cm, 0.3 mm

To be used for liver surgery
The suture material satisfies the essential requirements of Directive 93/42/EEC on medical devices and harmonized standard of European Pharmacopoeia for "sterile, braided, absorbable, synthetic threads"

Sterile

Other requirements: CE-Mark

1528 SURGICAL SUTURE, absorbable, USP 0, DS-25, 70cm

Absorbable suture material to be used in adaptation of soft tissues and in ligatures where medium-term absorbable thread material is required, including ophthalmic surgery and microsurgery

Material: polyglycolic acid, braided, coated with calcium stearate and polycaprolactone
Dyed with D+C violet no 2 or undyed (e.g. Serafit from company Serag Wiessner or similar)
The suture material satisfies the essential requirements of Directive 93/42/EEC on medical devices and harmonized standard of European Pharmacopoeia for "sterile, braided, absorbable, synthetic threads"

Sterile

Other requirements: CE-Mark

1529 SURGICAL SUTURE, absorbable, USP 0, HRX-36, 70cm

Absorbable suture material to be used in adaptation of soft tissues and in ligatures where medium-term absorbable thread material is required, including ophthalmic surgery and microsurgery

Material: polyglycolic acid, braided, coated with calcium stearate and polycaprolactone
Dyed with D+C violet no 2 or undyed (e.g. Serafit from company Serag Wiessner or similar)
The suture material satisfies the essential requirements of Directive 93/42/EEC on medical devices and harmonized standard of European Pharmacopoeia for "sterile, braided, absorbable, synthetic threads"

Sterile

Other requirements: CE-Mark

1530 SURGICAL SUTURE, absorbable, USP 1, HRX-36, 70cm

Absorbable suture material to be used in adaptation of soft tissues and in ligatures where medium-term absorbable thread material is required, including ophthalmic surgery and microsurgery

Material: polyglycolic acid, braided, coated with calcium stearate and polycaprolactone
Dyed with D+C violet no 2 or undyed (e.g. Serafit from company Serag Wiessner or similar)
The suture material satisfies the essential requirements of Directive 93/42/EEC on medical devices and harmonized standard of European Pharmacopoeia for "sterile, braided,

absorbable, synthetic threads”
Sterile
Other requirements: CE-Mark

1531 SURGICAL SUTURE, absorbable, USP 2-0, 6x45cm

Absorbable suture material to be used in adaptation of soft tissues and in ligatures where medium-term absorbable thread material is required, including ophthalmic surgery and microsurgery
Material: polyglycolic acid, braided, coated with calcium stearate and polycaprolactone
Dyed with D+C violet no 2 or undyed (e.g. Serafit from company Serag Wiessner or similar)
The suture material satisfies the essential requirements of Directive 93/42/EEC on medical devices and harmonized standard of European Pharmacopoeia for “sterile, braided, absorbable, synthetic threads”
Sterile
Other requirements: CE-Mark

1532 SURGICAL SUTURE, absorbable, USP 2-0, HR-26, 70cm

Absorbable suture material to be used in adaptation of soft tissues and in ligatures where medium-term absorbable thread material is required, including ophthalmic surgery and microsurgery
Material: polyglycolic acid, braided, coated with calcium stearate and polycaprolactone
Dyed with D+C violet no 2 or undyed (e.g. Serafit from company Serag Wiessner or similar)
The suture material satisfies the essential requirements of Directive 93/42/EEC on medical devices and harmonized standard of European Pharmacopoeia for “sterile, braided, absorbable, synthetic threads”
Sterile
Other requirements: CE-Mark

1533 SURGICAL SUTURE, absorbable, USP 3-0, 6x45cm

Absorbable suture material to be used in adaptation of soft tissues and in ligatures where medium-term absorbable thread material is required, including ophthalmic surgery and microsurgery
Material: polyglycolic acid, braided, coated with calcium stearate and polycaprolactone
Dyed with D+C violet no 2 or undyed (e.g. Serafit from company Serag Wiessner or similar)
The suture material satisfies the essential requirements of Directive 93/42/EEC on medical devices and harmonized standard of European Pharmacopoeia for “sterile, braided, absorbable, synthetic threads”
Sterile
Other requirements: CE-Mark

1534 SURGICAL SUTURE, absorbable, USP 3-0, HR-26, 70cm

Absorbable suture material to be used in adaptation of soft tissues and in ligatures where medium-term absorbable thread material is required, including ophthalmic surgery and microsurgery
Material: polyglycolic acid, braided, coated with calcium stearate and polycaprolactone
Dyed with D+C violet no 2 or undyed (e.g. Serafit from company Serag Wiessner or similar)
The suture material satisfies the essential requirements of Directive 93/42/EEC on medical devices and harmonized standard of European Pharmacopoeia for “sterile, braided,

absorbable, synthetic threads”
Sterile
Other requirements: CE-Mark

1535 SURGICAL SUTURE, absorbable, Vicril 0 Needle CT1

Material: combination of polyglycolic-acids (resorbable)
With 50 % strength after approx. 18 days
Size: USP 0, HRX-36, 70cm
Sterile
Other requirements: CE-Mark

1536 SURGICAL SUTURE, non-absorbable, USP 0, DS-30, 50cm

Synthetic monofilament non-absorbable sterile surgical suture for adaptation of soft tissues and for ligatures where non-absorbable suture material is indicated, including use in cardiovascular and neurological procedures as well as in microsurgery and ophthalmic procedures
Can also be used for holding sutures
Material: polyvinylidene fluoride
Dyed with solvent blue (e.g. Seralene from Serag Wiessner company or similar)
The suture material satisfies the essential requirements of Directive 93/42/EEC on medical devices and harmonized standard of European Pharmacopoeia for “sterile, braided, absorbable, synthetic threads”
Other requirements: CE-Mark

1537 SURGICAL SUTURE, non-absorbable, USP 0, HR-26, 75cm

Synthetic monofilament non-absorbable sterile surgical suture for adaptation of soft tissues and for ligatures where non-absorbable suture material is indicated, including use in cardiovascular and neurological procedures as well as in microsurgery and ophthalmic procedures
Can also be used for holding sutures
Material: polyvinylidene fluoride
Dyed with solvent blue (e.g. Seralene from Serag Wiessner company or similar)
The suture material satisfies the essential requirements of Directive 93/42/EEC on medical devices and harmonized standard of European Pharmacopoeia for “sterile, braided, absorbable, synthetic threads”
Other requirements: CE-Mark

1538 SURGICAL SUTURE, non-absorbable, USP 1, Needle CT1

Monofilament suture
Material: polypropylene
USP 1, 75 cm long
Needle CT 1 (e.g. Prolene 1 from company Ethicon or similar products)
The suture material satisfies the essential requirements of Directive 93/42/EEC on medical devices and harmonized standard of European Pharmacopoeia for “sterile, braided, absorbable, synthetic threads”
Sterile

1539 SURGICAL SUTURE, non-absorbable, USP 2/0, Needle CT1

Monofilament suture
Material: polypropylene
USP 2/0, 75 cm long
Needle CT 1 (e.g. Prolene 1 from company Ethicon or similar products)
The suture material satisfies the essential requirements of Directive 93/42/EEC on medical devices and harmonized standard of European Pharmacopoeia for "sterile, braided, absorbable, synthetic threads"
Sterile

1540 SURGICAL SUTURE, non-absorbable, USP 2-0, DS-25, 50cm

Synthetic monofilament non-absorbable sterile surgical suture for adaptation of soft tissues and for ligatures where non-absorbable suture material is indicated, including use in cardiovascular and neurological procedures as well as in microsurgery and ophthalmic procedures
Can also be used for holding sutures
Material: polyvinylidene fluoride
Dyed with solvent blue (e.g. Seralene from Serag Wiessner company or similar)
The suture material satisfies the essential requirements of Directive 93/42/EEC on medical devices and harmonized standard of European Pharmacopoeia for "sterile, braided, absorbable, synthetic threads"
Other requirements: CE-Mark

1541 SURGICAL SUTURE, non-absorbable, USP 2-0, HR-26, 70cm

Synthetic monofilament non-absorbable sterile surgical suture for adaptation of soft tissues and for ligatures where non-absorbable suture material is indicated, including use in cardiovascular and neurological procedures as well as in microsurgery and ophthalmic procedures
Can also be used for holding sutures
Material: polyvinylidene fluoride
Dyed with solvent blue (e.g. Seralene from Serag Wiessner company or similar)
The suture material satisfies the essential requirements of Directive 93/42/EEC on medical devices and harmonized standard of European Pharmacopoeia for "sterile, braided, absorbable, synthetic threads"
Other requirements: CE-Mark

1542 SURGICAL SUTURE, non-absorbable, USP 4-0, HR-17, 75cm

Synthetic monofilament non-absorbable sterile surgical suture for adaptation of soft tissues and for ligatures where non-absorbable suture material is indicated, including use in cardiovascular and neurological procedures as well as in microsurgery and ophthalmic procedures
Can also be used for holding sutures
Material: polyvinylidene fluoride
Dyed with solvent blue (e.g. Seralene from Serag Wiessner company or similar)
The suture material satisfies the essential requirements of Directive 93/42/EEC on medical devices and harmonized standard of European Pharmacopoeia for "sterile, braided, absorbable, synthetic threads"
Other requirements: CE-Mark

1543 SURGICAL SUTURE, non-absorbable, USP 5-0, HR-17, 75cm

Synthetic monofilament non-absorbable sterile surgical suture for adaptation of soft tissues and for ligatures where non-absorbable suture material is indicated, including use in cardiovascular and neurological procedures as well as in microsurgery and ophthalmic procedures

Can also be used for holding sutures

Material: polyvinylidene fluoride

Dyed with solvent blue (e.g. Seralene from Serag Wiessner company or similar)

The suture material satisfies the essential requirements of Directive 93/42/EEC on medical devices and harmonized standard of European Pharmacopoeia for "sterile, braided, absorbable, synthetic threads"

Other requirements: CE-Mark

1544 SWAB, small, 40 x 50 mm, cellulose, 12 folds, non sterile

Cellulose swabs are for general use e. g. to disinfect skin before blood taking

Material: cellulose

Soft, perforated design, extremely absorbent, chemically unobjectionable

From the roll, non-sterile, disposable

Can be sterilized by steam or hot air

Packaging: often as standard pack 2 rolls of 500 pieces

1545 SYRINGE, 2 ml, 2 parts, disposable

Material:

- clear polypropylene (medical grade) or polyethylene, transparent enough for easy reading and air bubbles detection

Barrel:

- cylindrical with easy-to-read, clear and water resistant graduations scale, ended by a conical male Luer connection

Plunger:

- must give a proofed seal

Packaging:

- 1 syringe packed in an individual sterilised peel-pack made of paper and/or plastic, protective carton packaging

Labeling:

- Exp date, lot number, items description, size, type of sterilization, manufacturer name, ref number, CE + Nr, total no. of units on carton

Other requirements: conforms to EN-ISO7886-1 and EN-ISO20594-1 standards

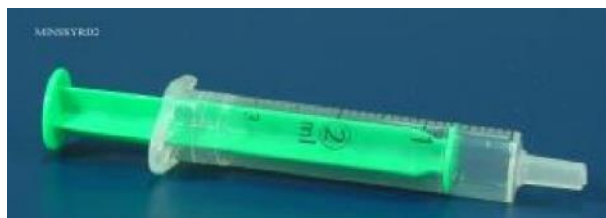

1546 SYRINGE, 5 ml, 2 parts, disposable

Material:

- clear polypropylene (medical grade) or polyethylene, transparent enough for easy reading

and air bubbles detection

Barrel:

- cylindrical with easy-to-read, clear and water resistant graduations scale, ended by a conical male Luer connection

Plunger:

- must give a proofed seal

Packaging:

- 1 syringe packed in an individual sterilised peel-pack made of paper and/or plastic, protective carton packaging

Labeling:

- Exp date, lot number, items description, size, type of sterilization, manufacturer name, ref number, CE + Nr, total no. of units on carton

Other requirements: conforms to EN-ISO7886-1 and EN-ISO20594-1 standards

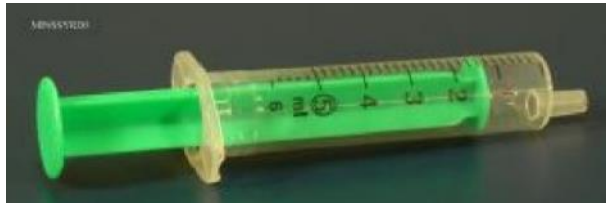

1547 **SYRINGE, 10 ml, 2 parts, disposable**

Material:

- clear polypropylene (medical grade) or polyethylene, transparent enough for easy reading and air bubbles detection

Barrel:

- cylindrical with easy-to-read, clear and water resistant graduations scale, ended by a conical male Luer connection

Plunger:

- must give a proofed seal

Packaging:

- 1 syringe packed in an individual sterilised peel-pack made of paper and/or plastic, protective carton packaging

Labeling:

- Exp date, lot number, items description, size, type of sterilization, manufacturer name, ref number, CE + Nr, total no. of units on carton

Other requirements: conforms to EN-ISO7886-1 and EN-ISO20594-1 standards



1548 **SYRINGE, 20 ml, 2 parts, disposable**

Material:

- clear polypropylene (medical grade) or polyethylene, transparent enough for easy reading and air bubbles detection

Barrel:

- cylindrical with easy-to-read, clear and water resistant graduations scale, ended by a conical

male Luer connection

Plunger:

- must give a proofed seal

Packaging:

- 1 syringe packed in an individual sterilised peel-pack made of paper and/or plastic, protective carton packaging

Labeling:

- Exp date, lot number, items description, size, type of sterilization, manufacturer name, ref number, CE + Nr, total no. of units on carton

Other requirements: conforms to EN-ISO7886-1 and EN-ISO20594-1 standards

1549 SYRINGE, 50 ml, 2 parts, disposable

Material:

- clear polypropylene (medical grade) or polyethylene, transparent enough for easy reading and air bubbles detection

Barrel:

- cylindrical with easy-to-read, clear and water resistant graduations scale, ended by a conical male Luer connection

Plunger:

- must give a proofed seal

Packaging:

- 1 syringe packed in an individual sterilised peel-pack made of paper and/or plastic, protective carton packaging

Labeling:

- Exp date, lot number, items description, size, type of sterilization, manufacturer name, ref number, CE + Nr, total no. of units on carton

Other requirements: conforms to EN-ISO7886-1 and EN-ISO20594-1 standards

1550 SYRINGE, BLADDER, 100 ml

Syringe, two pieces: barrel with Luer nozzle and piston

Graduated scale on the barrel, easy to read

Barrel sufficiently transparent to allow easy measurement of the fluid in the syringe

Material: Polyethylene (PEF) or polypropylene (PP)

Disposable, sterile

Sterilisation method: Ethylene oxide

Packaging:

- 1 syringe packed in an individual sterilised peel-pack made of paper and/or plastic

Labeling:

- Exp date, lot number, items description, size, type of sterilization, manufacturer name, ref number, CE + Nr

Other requirements: conforms to EN-ISO 7886-1, EN-ISO 20594, EN 550-ISO 11135

1551 TABLE, DELIVERY, dismantable

Gynaecological table with detachable leg rests and basin used for gynaecological examinations and deliveries

Two-part stable steel construction, white, powder-coated

Consisting of:

- Head part
- Backrest: mechanically adjustable, standard guides on the head part
- Foot part: mobile, with lockable castors; diameter minimum 10 cm

- Leg-rests: removable with fastening clamps and cuffs, stainless steel rod, plastic rests
 - Two-part mattress: washable, mid density foam, covered with smooth upholstery
 - Waste bowl: swing able waste bowl, stainless steel
- Measurements assembled approx. (LxWxH): 2030 x 970 x 695 mm
Packaging: dismantled, in protective wooden crate



1552 TABLE, EXAMINATION, foldable, tripartite with carry bag

Foldable examination table (tripartite), used for medical examinations

Material:

- Frame: stainless steel in epoxy painted coated metal
- Top is upholstered and covered with washable chlorine –resistant material
- Cushion: foam, 5 cm thick, covered with a cleanable chlorine-resistant synthetic upholstery (plastic, vinyl)

Transverse bar to be fixed for stability

Dimensions unfolded: approx. 80 x 60 x 190 cm

Weight: approx.. 15 kg,

Cushions cleanable with soap and disinfected with 0.5 % chlorine solution

Packaging: delivered folded; dimensions approx. 80 x 60 x 15 cm



1553 TABLE, INSTRUMENTS, 60 x 48 cm, Mayo type, 4 wheels

Small pedestal table on wheels, used during surgery for keeping the instruments in use near the operating field

Material of tray, stand and base: stainless steel

Tray:

- Length 600 mm, width 480 mm
- Height of ridge 10 mm
- Adjustable in height from 825 to 1300 mm

Stand:

- with adjusting screw
- screw to lock chosen height

Base

- Fork-shaped (in U): 450x 610mm
- Made of square tube size: approx 35 x 35 mm
- On 80 mm castors

Other requirements: Resistant to corrosion (suitable for tropical environment) and decontamination
Knock down construction



1554 TABLE, INSTRUMENTS, 100 x 60 cm, 2 shelves, with castors

Square instrument table used during surgery for keeping instruments in use near the operating field

Dimension assembled: L/W/H: approx 1000 x 600 x 820 mm

Shelves:

- Material: Stainless steel
- Size: 1000 x 600 mm; thickness: 1.35 mm

Height from floor to first shelf approx 430 mm, to second shelf approx. 820 mm

Frame:

- In square tube size: 25 x 25 mm
- Material: Stainless steel

Wheels/castors:

Diameter 100 mm with 95 mm rubber bumper

Other requirements: Resistant to corrosion (suitable for tropical environment) and decontamination
Knock down construction



1554 TOOL KIT, small



1555 TABLE, OPERATING, surgical, mechanical, with accessories

Mechanical operating table, used in operating theatres in developing countries or in emergency situations

Like Medeco SSM80

Robust table, simple but multifunctional, entirely mechanical, stable, light and not too cumbersome

Radio translucent permitting X-rays

Mechanical decline/incline and lateral tilting

Can be used on uneven ground (4 adjustable jacks attached to large metal runners)

Can be rapidly assembled and dismantled

Design which allows storage for long periods of time under all conditions

Consisting of 4 articulating sections

Dimensions:

- Total length: 1.90m
- Overall width: 0, 515m
- Width of the sections: 0.475 m
- Height: 0.75 to 1m (mechanically adjustable height)

Mechanically adjustable inclinations:

- Maximum decline: 35°
- Maximum incline: 30°
- Maximum lateral tilt: 20°

Crankshaft which allows minute adjustment of the table

- Headrest, non removable: Length: 0.34m; Incline: 90° + 60°
- Backrest, non removable: Length: 0.55 m; Incline: -50° to +80°
- Seat: length: 0.44m
- Extension: length: 0.57m; Incline: -90° to +30°

Legs with 4 adjustable jacks on large metallic runners

Anticorrosion measures:

- stainless steel satinised
- light alloys anodised steel, phosphatised, coated with anti-chip paint

Sections:

- formed by a sandwich plastic/anodised aluminium
- permeable to X rays
- unbreakable
- insensible to climatic corrosion
- dimensions: 30 x 40 cm, thickness: 6mm

4 cushions, antistatic and permeable to X rays, thickness: 30mm

To be supplied with: 4 Sliding clamps for holding accessories

Mattress (4 sections) in black lectolite

10 Vice, to hold accessories

Hoop, for the anaesthetists field

Pair of cushioned cylindrical shoulder supports

Pair of cushioned leather wrist straps

Cushioned perfusion armrest

Cushioned side rest

Pair of cushioned leg straps

Pan for X-ray cassettes

Infusion stand, attachable to table

Pair of leg supports plus straps

Annex for hand surgery

Total weight including accessories: 80 kg

Other requirements: Temperature range for usage/storage: -15° C to +50° C
Should conform to ISO standard



1556 TAP, 3-WAYS, for infusions

Three way stop cock for simultaneous infusions

Material: transparent polycarbonate/P, non-toxic medical grade material

With 3 Luer lock connectors

Sterile, disposable, pyrogen-free

Packaging:

- 1 tap packed in an individual sterilised peel-pack made of paper and/or plastic, protective carton packaging

Labeling:

- Exp date, lot number, items description, size, type of sterilization, manufacturer name, ref number, CE + Nr, total no. of units on carton



1557 TAPE, ADHESIVE DRESSING, 6 cm x 5 m, roll

Textile adhesive strip with absorbing compress/pad

Material:

- Tape: Woven or non woven textile
- Adhesive: mixture of rubber, resins and lanolin
- Compress/pad: non woven impregnated with Chlorhexidinum 0,15%

Air-permeable

Well tolerated by the skin due to hypoallergenic adhesive

Highly absorbent pad

Does not stick to the wound

Non-stretch

With fissures to admit air

Needed length to be cut according to need

Colour: White or flesh coloured

Storage:

- Protect from humidity
- Temperature below 25 °

Packaging and labeling:

one roll in a protective box, should mention name and/or trademark of the manufacturer, lot number, manufacturing date by year and month, single CE marking, product description

Other requirements: meets Pharmacopoeia specifications



1558 TAPE, ADHESIVE, CREPE, 19mm x 50m

Paper based roll

1559 TAPE, ADHESIVE, zinc oxide, 1.5 cm x 5 m

Adhesive tape used to secure dressings and certain medical devices on the skin

Material:

- Textile base: woven, silk or acetate taffeta
- Zinc oxide-based adhesive, mixed with rubber, resins and lanolin

Heated on contact with skin, zinc oxide allows the tape to stick

Sticks strongly to dry skin but can be removed without causing any significant lesion

Good cutaneous tolerance

Non stretch

Waterproof

With notched edges so that it can be torn by hand

Packaging: roll in protective box or wrapping, should mention name and/or trademark of the manufacturer, lot number, manufacturing date by year and month, single CE marking, product description

Other requirements: meets the European Pharmacopoeia specifications

1560 TAPE, ADHESIVE, zinc oxide, 2.5 cm x 5 m

Adhesive tape used to secure dressings and certain medical devices on the skin

Material:

- Textile base: woven, silk or acetate taffeta
- Zinc oxide-based adhesive, mixed with rubber, resins and lanolin

Heated on contact with skin, zinc oxide allows the tape to stick

Sticks strongly to dry skin but can be removed without causing any significant lesion

Good cutaneous tolerance

Non stretch

Waterproof

With notched edges so that it can be torn by hand

Packaging: roll in protective box or wrapping, should mention name and/or trademark of the manufacturer, lot number, manufacturing date by year and month, single CE marking, product description

Other requirements: meets the European Pharmacopoeia specifications

1561 TAPE, ADHESIVE, zinc oxide, 5 cm x 5 m

Adhesive tape used to secure dressings and certain medical devices on the skin

Material:

- Textile base: woven, silk or acetate taffeta
- Zinc oxide-based adhesive, mixed with rubber, resins and lanolin

Heated on contact with skin, zinc oxide allows the tape to stick

Sticks strongly to dry skin but can be removed without causing any significant lesion

Good cutaneous tolerance

Non stretch

Waterproof

With notched edges so that it can be torn by hand

Packaging: roll in protective box or wrapping, should mention name and/or trademark of the manufacturer, lot number, manufacturing date by year and month, single CE marking, product description

Other requirements: meets the European Pharmacopoeia specifications

1562 TAPE, AUTOCLAVE, 19 mm x 50 m

Provides immediate identification of processed items (passage indicator) and serves as a closure tape to seal sterilization packs

Material:

- Paper crepe with chemical indicator
- Non-toxic
- Lead free

Paper crepe tape specially imprinted with a chemical indicator (diagonal stripes) that will darken

The chemical process indicator lines on the steam tape change to dark brown on a beige background when exposed to the steam sterilization process

The chemical reaction changes the colour irreversibly

Allows also to seal packs and to write on it

Easy to interpret

Packaging and labeling: individual rolls with adequate protecting wrap, marked with lot number and expiry date

Other requirements: conforms to ISO 11140-1 Class 1



1565 TEST TUBE, for Benedict test glass, 160x16mm round bottom rimless

Used for the semi-quantitative examination of glucose in urine with Benedict solution, the mixture in the test tube is heated on a spirit lamp

Material: real laboratory glass

Round bottom, rimless

Autoclavable

Uniform wall thickness

Packaging: protective

1566 TEST TUBE, GLASS, 16x100 mm, 12ml, round bottom

Non-sterile, autoclaveable

Packaging: protective packaging

1569 THERMOMETER, ear, electronic

Infrared sensor tip

LCD-display

Battery powered (2 Lithium coin cells)

Measuring range: 34°C - 42,2°C

Measuring time: 2 - 3 sek

Height: approx. 15 cm

To be supplied with: 1000 plastic covers for sensor tip
Batteries



1570 THERMOMETER, medical, mercury-free

For measuring temperature (rectal, oral and axillary)

Material: Glass and Gallistan

Clinical thermometer, without mercury

Waterproof

Length: 115 ± 5 mm

Width: 14 ± 3 mm

Minimum temperature: 35°C

Maximum temperature: 42°C

Graduations in Celsius every 0.1°C , with major graduations every 1°C , printed on a central metallic or plastic bar (scale) upon which the glass tube containing the gallistan is mounted

Gallium column:

glass tube of 1.2 mm external diameter and 0.8 mm internal diameter of which the bottom is coloured in order to contrast with the gallistan, so making the reading easier

Packaging: individual protection, protective case with plastic housing at the bottom in order to protect the most fragile end of the thermometer where the Gallium reservoir is situated



1571 THERMOMETER, MINI-MAXI, -30 to $+50^{\circ}\text{C}$

Thermometer to measure the minimum/maximum and present temperature e.g. in a refrigerator (containing blood units or reagents)

Material: plastic housing

Push button to "zero" it

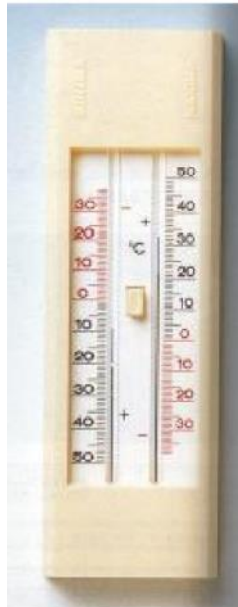

1572 TIMER, stopwatch, 60 min reading to 1/5 sec., chromed metal

Mechanical addition timer to wind up
Shock proof
Unbreakable spring
ABS-special housing
Diameter: approx. 55 mm
With neck cord and etui
1/10 s-resolution, 60 minutes read out

1573 TONGUE DEPRESSOR, wood, non sterile

Used to examine throat and mouth disease
Material: Birch wood
Smooth surface with rounded edges
Stable and splinter proofed
Size: 150 x 20 x 1,5 mm (L x W x H)
Packaging: box of 100 pieces



1575 TOURNIQUET, COTTON, 42x2.4cm, elastic, with buckle

Cotton woven strip with plastic buckle
Easy one hand operation
Disinfectable with common chemical agents and autoclavable



1576 TOURNIQUET, PNEUMATIC, with cuff leg/arm + pump/manometer

Allow to empty venous blood by applying circular compression
Inflatable rubber bladder surrounded by a large material band
One rubber tube connected to pump-manometer

Components:

1 Hand pump-manometer

- Chrome plated manometer with special tempered copper-benyllium diaphragm
- Aluminium scale Graduated to 700 mmHg

1 Arm cuff: 57x 9 cm (washable plastic material)

1 Leg cuff: 96 x 12.5 cm (washable plastic material)

1 Set of tubes and connectors

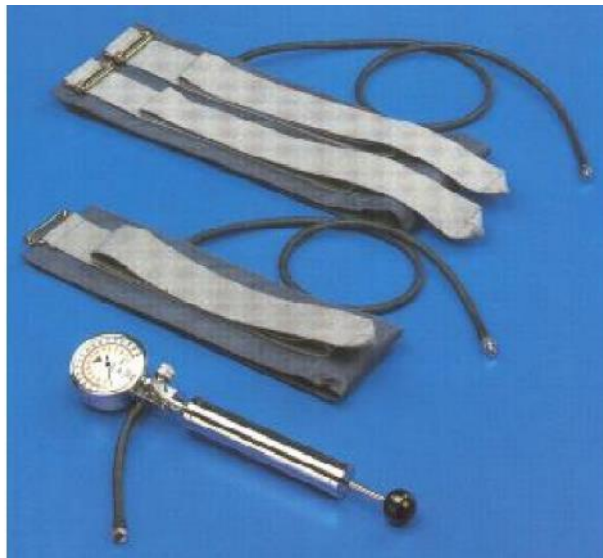

1577 TOWEL, cotton, 60 x 90 cm

Washable at 90°C
Material: cotton

1578 TOWEL, cotton, approx. 20 x 30 cm

1579 TRAY, INSTRUMENT, GRID, 210 x 145 x 50 mm, stainless steel

Material: stainless steel wire net, electrolyte polished

Maximum square opening approx 6,5 mm

Wire diameter 1,5 mm

This design gives maximum usage for cleaning results and at the same time prevents instruments to penetrate the sides of the tray

All cross-points in the network and vertical wires to top and bottom frames to be point-welded

All free wire ends to be soft-polished to prevent hurting staff when being handled

The bottom wire construction to include a rigid, 3 mm diameter, stainless steel wire frame to give airing space between goods and work surface

Electrolyte polished to get soft and clean surfaces

Easy to clean and disinfect

Modular design

Stackable

To be used with: AUTOCLAVE, COMBINED, 90 l, elec./kero., incl. kero. burner
SHEET, COTTON, sterile wrapping, 75 x 75 cm



1580 TRAY, INSTRUMENT, GRID, 240 x 250 x 50 mm, stainless steel

Material: stainless steel wire net, electrolyte polished

Maximum square opening approx 6,5 mm

Wire diameter 1,5 mm

This design gives maximum usage for cleaning results and at the same time prevents instruments to penetrate the sides of the tray

All cross-points in the network and vertical wires to top and bottom frames to be point-welded

All free wire ends to be soft-polished to prevent hurting staff when being handled

The bottom wire construction to include a rigid, 3 mm diameter, stainless steel wire frame to give airing space between goods and work surface

Electrolyte polished to get soft and clean surfaces

Easy to clean and disinfect

Modular design

Stackable

To be used with: AUTOCLAVE, COMBINED, 90 l, elec./kero., incl. kero. Burner
(autoclave combined, 90l) BASKET, stainless steel
SHEET, COTTON, sterile wrapping, 100 x 100 cm

Other requirements: Should fit horizontally in the the BASKET, stainless steel of this sterilizer while in double wrapping

1581 TRAY, LABORATORY

For collection and transportation of blood specimen, designed in accordance to Sahli method for Haemoglobin determination

Like Assistent 2000/1 and 2000/2

Components:

- Plastic tray approx 35 x 25 x 4 cm
- Stand with 4 compartments for pipettes etc and 5 placeholder for 5 bottles

Material:

- Tray: melamine
- Stand: plexiglass

To be cleaned easily

The stand can be placed on one side of the tray, leaving space for additional materials



1582 TROLLEY, ANEASTHESIA, 940 x 625cm, 2 shelves, 2 drawers

Robust and solid for use in tough conditions

Material: stainless steel
knock down construction

2 Drawers

2 Shelves

On 4 castors (diameter 8 cm) of which 2 are lockable

Can be washed and disinfected

1583 TROUSERS, SURGICAL, reusable, cotton, size L

Trousers with a string in the waist band, with or without foot cuffs

Material: woven cotton 100%

Weight per m2: minimum 145 g

Colour: blue or green

Size L:

- Length: 118 cm
- Chest measurement: 108-110 cm

Washing: normal, withstands boiling and autoclaving, resists to chlorine 0.5%

Packaging: protected in a plastic bag, single or multiple unit



1584 TROUSERS, SURGICAL, reusable, cotton, size M

Trousers with a string in the waist band, with or without foot cuffs

Material: woven cotton 100%

Weight per m2: minimum 145 g

Colour: blue or green

Size M:

- Length: 109 cm
- Chest measurement: 99-103 cm

Washing: normal, withstands boiling and autoclaving, resists to chlorine 0.5%

Packaging: protected in a plastic bag, single or multiple unit

1585 TROUSERS, SURGICAL, reusable, cotton, size S

Trousers with a string in the waist band, with or without foot cuffs

Material: woven cotton 100%

Weight per m2: minimum 145 g

Colour: blue or green

Size S:

- Length: 102 cm
- Chest measurement: 89-92 cm

Washing: normal, withstands boiling and autoclaving, resists to chlorine 0.5%

Packaging: protected in a plastic bag, single or multiple unit

1586 TROUSERS, SURGICAL, reusable, cotton, size XL

Trousers with a string in the waist band, with or without foot cuffs

Material: woven cotton 100%

Weight per m2: minimum 145 g

Colour: blue or green

Size XL:

- Length: 122 cm
- Chest measurement: 115-122 cm

Washing: normal, withstands boiling and autoclaving, resists to chlorine 0.5%

1587 TUB, plastic, approx. 70 l

To be used for disinfectant solution in entrance and exit area of isolation unit (Step-in basin)

Size: approx. 50 x 80 x 40 cm

40 cm maximum height of sides

1588 TUBE FOR CROSS-MATCH, GLASS, 12 x 75 mm, 4 ml

Used for compatibility testing in blood transfusions
Material: glass or polysterol, transparent
Capacity: 4 ml
Packaging: protective

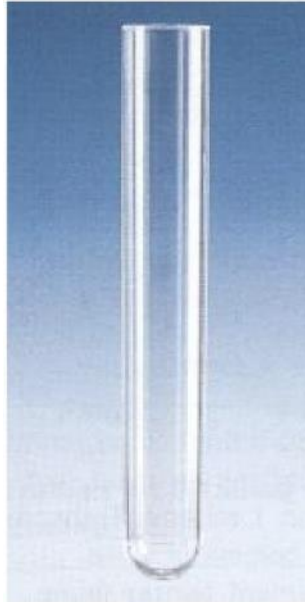

1589 TUBE, CAPILLARY, MICRO-HAEMATOCRIT, 75 mm, heparinised

Fine glass tube provided with anticoagulant, designed to sample blood through capillary
Used to determine the haematocrit, as well as the concentration of parasites (Trypanosoma)
Coated with anticoagulant heparin
Capacity 75 µl
Disposable
Packaging: protective, expiry date on the label
To be used with: WAX FOR HAEMATOCRIT

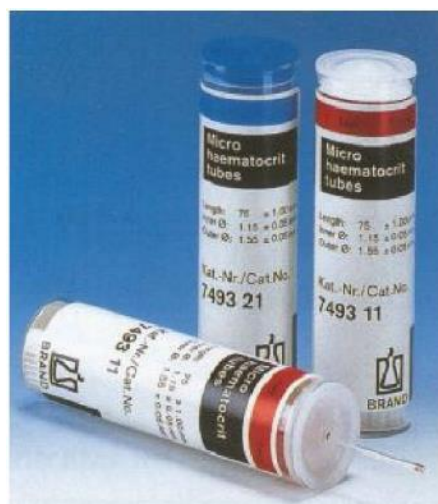

1590 TUBE, ENDOTRACHEAL, No 03, without cuff, sterile, disposable

Components:

- Tracheal tube without cuff
- Connector (ext. Ø15 mm)

Material:

- Tube: Transparent polyvinyl chloride (PVC) or polyurethane
- Connector: PVC

The endotracheal tubes are standard in all respects:

Dimension, connection, markings

Tube:

- With oro-nasal angle of 37.5°
- Continuous X-ray line
- Black position indicator for correct tube placement
- Distal end: open bevelled (obliquely cut)

Magill-type connector: ext. Ø15mm at proximal end of the tracheal tube to fit standard connection to the ventilation device

Tube size Nr 3: length 170mm, I.D 3.0/O.D 4.0mm

Packaging: must be supplied in sterilised peel pack

Labeling should mention: name and/or trademark of the manufacturer, sterile, lot number, expiry date by year and month, "for single use". CE + number, product description, instruction for use

Other requirements: should conform to ISO 5361 and ISO 7228 (connectors)



1591 TUBE, ENDOTRACHEAL, No 04, without cuff, sterile, disposable

Components:

- Tracheal tube without cuff
- Connector (ext. Ø15 mm)

Material:

- Tube: Transparent polyvinyl chloride (PVC) or polyurethane
- Connector: PVC

The endotracheal tubes are standard in all respects:

Dimension, connection, markings

Tube:

- With oro-nasal angle of 37.5°
- Continuous X-ray line
- Black position indicator for correct tube placement
- Distal end: open beveled (obliquely cut)

Magill-type connector: ext. Ø15mm at proximal end of the tracheal tube to fit standard connection to the ventilation device

Tube size Nr 4: length 210mm, I.D 4,05/O.D 5.03mm

Packaging: must be supplied in sterilized peel pack

Labeling should mention: name and/or trademark of the manufacturer, sterile, lot number, expiry date by year and month, "for single use". CE + number, product description, instruction for use

Other requirements: should conform to ISO 5361 and ISO 7228 (connectors)

1592 TUBE, ENDOTRACHEAL, No 05, without cuff, sterile, disposable

Components:

- Tracheal tube without cuff
- Connector (ext. Ø15 mm)

Material:

- Tube: Transparent polyvinyl chloride (PVC) or polyurethane
- Connector: PVC

The endotracheal tubes are standard in all respects:

Dimension, connection, markings

Tube:

- With oro-nasal angle of 37.5°
- Continuous X-ray line
- Black position indicator for correct tube placement
- Distal end: open bevelled (obliquely cut)

Magill-type connector: ext. Ø15mm at proximal end of the tracheal tube to fit standard connection to the ventilation device

Tube size Nr 5: length 250mm, I.D 5.0/O.D 6.7mm

Packaging: must be supplied in sterilised peel pack

Labeling should mention: name and/or trademark of the manufacturer, sterile, lot number, expiry date by year and month, "for single use". CE + number, product description, instruction for use

Other requirements: should conform to ISO 5361 and ISO 7228 (connectors)

1593 TUBE, ENDOTRACHEAL, No 06, with cuff, sterile, disposable

Components:

- Tracheal tube with cuff
- Cuff: situated near the distal end, connected to an external pilot balloon with self-sealing valve
- Connector: proximal end of tracheal tube to fit standard connection to the ventilation device

Material:

- Tube: Transparent polyvinyl chloride (PVC) or polyurethane
- Connector: PVC transparent or blue
- Pilot balloon: siliconed latex or PVC siliconised
- Tracheal cuff: PVC siliconised or siliconised latex rubber

The endotracheal tubes are standard in all respects:

Dimension, connection, markings

Tube:

- With oro-nasal angle of 37.5°
- Continuous X-ray line
- Black position indicator for correct tube placement
- Distal end : with open beveled (obliquely cut), Magill-type

Tracheal cuff:

- Situated near the tube distal end (can be optional)
- Provides an airtight seal between the tube and the tracheal wall to protect the patient's airways from stomach aspiration
- Allows efficient ventilation during IPPV
- With low-pressure cuff to avoid inadequate pressure on the trachea mucous membrane to prevent damage or even necrosis
- Cuff is inflated via a small-bore inflation tube, welded onto the outside tracheal tube or built into its wall
- The inflation tube is connected to its proximal end to a small pilot balloon that is designed to give an indication of the cuff distension
- Includes an a device for maintaining certain pressure in the circuit (plug, shut-off valve, non-return valve) with Luer tip

Tubes are fitted with standard ext. Ø15mm connectors
Tube size Nr 6: length: 290 mm, I.D 6.0/O.D 8.0 cuff Ø18.5 mm
Unit presentation: 1 endotracheal tube, sterile, disposable
Packaging: must be supplied in sterilized peel pack
Labeling should mention: name and/or trademark of the manufacturer, sterile, lot number, expiry date by year and month, "for single use", CE + number; product description, instruction for use
Other requirements: should conform to ISO 5361 and ISO 7228 (connectors)



1594 TUBE, ENDOTRACHEAL, No 07, with cuff, sterile, disposable

Components:

- Tracheal tube with cuff
- Cuff: situated near the distal end, connected to an external pilot balloon with self-sealing valve
- Connector: proximal end of tracheal tube to fit standard connection to the ventilation device

Material:

- Tube: Transparent polyvinyl chloride (PVC) or polyurethane
- Connector: PVC transparent or blue
- Pilot balloon: siliconed latex or PVC siliconised
- Tracheal cuff: PVC siliconised or siliconised latex rubber

The endotracheal tubes are standard in all respects:

Dimension, connection, markings

Tube:

- With oro-nasal angle of 37.5°
- Continuous X-ray line
- Black position indicator for correct tube placement
- Distal end : with open beveled (obliquely cut), Magill-type

Tracheal cuff:

- Situated near the tube distal end (can be optional)
- Provides an airtight seal between the tube and the tracheal wall to protect the patient's airways from stomach aspiration
- Allows efficient ventilation during IPPV
- With low-pressure cuff to avoid inadequate pressure on the trachea mucous membrane to prevent damage or even necrosis
- Cuff is inflated via a small-bore inflation tube, welded onto the outside tracheal tube or built into its wall

- The inflation tube is connected to its proximal end to a small pilot balloon that is designed to give an indication of the cuff distension
 - Includes an a device for maintaining certain pressure in the circuit (plug, shut-off valve, non-return valve) with Luer tip
- Tubes are fitted with standard ext. Ø15mm connectors
Tube size Nr 7: length: 320 mm, I.D 7.0/O.D 9.3 cuff Ø 24 mm
Unit presentation: 1 endotracheal tube, sterile, disposable
Packaging: must be supplied in sterilized peel pack
Labeling should mention: name and/or trademark of the manufacturer. sterile, lot number, expiry date by year and month, "for single use", CE + number; product description, instruction for use
Other requirements: should conform to ISO 5361 and ISO 7228 (connectors)

1595 TUBE, ENDOTRACHEAL, No 08, with cuff, sterile, disposable

Components:

- Tracheal tube with cuff
- Cuff: situated near the distal end, connected to an external pilot balloon with self-sealing valve
- Connector: proximal end of tracheal tube to fit standard connection to the ventilation device

Material:

- Tube: Transparent polyvinyl chloride (PVC) or polyurethane
- Connector: PVC transparent or blue
- Pilot balloon: siliconed latex or PVC siliconised
- Tracheal cuff: PVC siliconised or siliconised latex rubber

The endotracheal tubes are standard in all respects:

Dimension, connection, markings

Tube:

- With oro-nasal angle of 37.5°
- Continuous X-ray line
- Black position indicator for correct tube placement
- Distal end : with open beveled (obliquely cut), Magill-type

Tracheal cuff:

- Situated near the tube distal end (can be optional)
- Provides an airtight seal between the tube and the tracheal wall to protect the patient's airways from stomach aspiration
- Allows efficient ventilation during IPPV
- With low-pressure cuff to avoid inadequate pressure on the trachea mucous membrane to prevent damage or even necrosis
- Cuff is inflated via a small-bore inflation tube, welded onto the outside tracheal tube or built into its wall
- The inflation tube is connected to its proximal end to a small pilot balloon that is designed to give an indication of the cuff distension
- Includes an a device for maintaining certain pressure in the circuit (plug, shut-off valve, non-return valve) with Luer tip

Tubes are fitted with standard ext. Ø15mm connectors

Tube size Nr 8: length: 340 mm, I.D 8.0/O.D 10.7 cuff Ø 26 mm

Unit presentation: 1 endotracheal tube, sterile, disposable

Packaging: must be supplied in sterilized peel pack

Labeling should mention: name and/or trademark of the manufacturer. sterile, lot number, expiry date by year and month, "for single use", CE + number; product description, instruction for use

Other requirements: should conform to ISO 5361 and ISO 7228 (connectors)

1596 TUBE, ENDOTRACHEAL, No 09, with cuff, sterile, disposable

Components:

- Tracheal tube with cuff
- Cuff: situated near the distal end, connected to an external pilot balloon with self-sealing valve
- Connector: proximal end of tracheal tube to fit standard connection to the ventilation device

Material:

- Tube: Transparent polyvinyl chloride (PVC) or polyurethane
- Connector: PVC transparent or blue
- Pilot balloon: siliconed latex or PVC siliconised
- Tracheal cuff: PVC siliconised or siliconised latex rubber

The endotracheal tubes are standard in all respects:

Dimension, connection, markings

Tube:

- With oro-nasal angle of 37.5°
- Continuous X-ray line
- Black position indicator for correct tube placement
- Distal end : with open beveled (obliquely cut), Magill-type

Tracheal cuff:

- Situated near the tube distal end (can be optional)
- Provides an airtight seal between the tube and the tracheal wall to protect the patient's airways from stomach aspiration
- Allows efficient ventilation during IPPV
- With low-pressure cuff to avoid inadequate pressure on the trachea mucous membrane to prevent damage or even necrosis
- Cuff is inflated via a small-bore inflation tube, welded onto the outside tracheal tube or built into its wall
- The inflation tube is connected to its proximal end to a small pilot balloon that is designed to give an indication of the cuff distension
- Includes an a device for maintaining certain pressure in the circuit (plug, shut-off valve, non-return valve) with Luer tip

Tubes are fitted with standard ext. Ø15mm connectors

Tube size Nr 9: length: 350 mm, I.D 9.0/O.D 12.0 cuff Ø 28 mm

Unit presentation: 1 endotracheal tube, sterile, disposable

Packaging: must be supplied in sterilized peel pack

Labeling should mention: name and/or trademark of the manufacturer. sterile, lot number, expiry date by year and month, "for single use", CE + number; product description, instruction for use

Other requirements: should conform to ISO 5361 and ISO 7228 (connectors)

1597 TUBE, FEEDING, CH 05, Luer tip, 50 cm, disposable

Tube with single channel

Material: Polyvinyl chloride (PVC)

With graduations over the first 20cm from the distal end, generally radio-opaque

Rounded end, 2 side holes

Radio-opaque mark, Luer tip with stopper

Length: 40cm to 50 cm

Packaging: 1 feeding tube, sterile, disposable

Must be supplied in sterilised peel pack or blister

Labeling should mention: name and/or trademark of the manufacturer, sterile, lot number, expiry date by year and month, "for single use", CE + number; product description, instruction for use

Other requirements: Recommended for infants and children

To be used with: SYRINGE, BLADDER, 100 ml

1598 TUBE, FEEDING, CH 06, Luer tip, 50 cm, disposable

Tube with single channel
Material: Polyvinyl chloride (PVC)
With graduations over the first 20cm from the distal end, generally radio-opaque
Rounded end, 2 side holes
Radio-opaque mark, Luer tip with stopper
Length: 40cm to 50 cm
Packaging: 1 feeding tube, sterile, disposable
Must be supplied in sterilised peel pack or blister
Labeling should mention: name and/or trademark of the manufacturer, sterile, lot number, expiry date by year and month, "for single use", CE + number; product description, instruction for use
Other requirements: Recommended for infants and children
To be used with: SYRINGE, BLADDER, 100 ml

1599 TUBE, FEEDING, CH 08, Luer tip, 50 cm, disposable

Tube with single channel
Material: Polyvinyl chloride (PVC)
With graduations over the first 20cm from the distal end, generally radio-opaque
Rounded end, 2 side holes
Radio-opaque mark, Luer tip with stopper
Length: 40cm to 50 cm
Packaging: 1 feeding tube, sterile, disposable
Must be supplied in sterilised peel pack or blister
Labeling should mention: name and/or trademark of the manufacturer, sterile, lot number, expiry date by year and month, "for single use", CE + number; product description, instruction for use
Other requirements: Recommended for infants and children
To be used with: SYRINGE, BLADDER, 100 ml

1600 TUBE, FEEDING, CH 10, Luer tip, 50 cm, disposable

Tube with single channel
Material: Polyvinyl chloride (PVC)
With graduations over the first 20cm from the distal end, generally radio-opaque
Rounded end, 2 side holes
Radio-opaque mark, Luer tip with stopper
Length: 40cm to 50 cm
Packaging: 1 feeding tube, sterile, disposable
Must be supplied in sterilised peel pack or blister
Labeling should mention: name and/or trademark of the manufacturer, sterile, lot number, expiry date by year and month, "for single use", CE + number; product description, instruction for use
Other requirements: Recommended for infants and children
To be used with: SYRINGE, BLADDER, 100 ml

1601 TUBE, FEEDING, CH 16, Luer tip, 50 cm, disposable

Tube with single channel
Material: Polyvinyl chloride (PVC)
With graduations over the first 20cm from the distal end, generally radio-opaque
Rounded end, 2 side holes
Radio-opaque mark, Luer tip with stopper

Length: 40cm to 50 cm
Packaging: 1 feeding tube, sterile, disposable
Must be supplied in sterilised peel pack or blister
Labeling should mention: name and/or trademark of the manufacturer, sterile, lot number, expiry date by year and month, "for single use", CE + number; product description, instruction for use
Other requirements: Recommended for infants and children
To be used with: SYRINGE, BLADDER, 100 ml

1602 TUBE, GASTRIC, CH 05, conical tip, 120cm, sterile, disp.

Tube with single channel
Proximal end has a connector for connecting to aspiration system
Material: Polyvinyl chloride (PVC)
Tube has radio-opaque markings at 40, 50, 60 and 70cm from distal end corresponding to: cardia, stomach, duodenum, jejunum
Conical tip
Can be used with a syringe with conical nozzle for manual suction, tube feeding or for gastric aspiration
Can also be used with pump, suction, foot operated (anaesthesia) or suction machine
A bi-conical connector is required to connect to suction tubes (CONNECTOR, bi-conical, symmetric. ext dia. 7 to 11 mm autocl.)
Packaging: Must be supplied in sterile peel pack packaging
Labeling should mention: name and/or trademark of the manufacturer, sterile, lot number, expiry date by year and month, "for single use", CE + number; product description, instruction for use

1603 TUBE, GASTRIC, CH 06, conical tip, 120cm, sterile, disp.

Tube with single channel
Proximal end has a connector for connecting to aspiration system
Material: Polyvinyl chloride (PVC)
Tube has radio-opaque markings at 40, 50, 60 and 70cm from distal end corresponding to: cardia, stomach, duodenum, jejunum
Conical tip
Can be used with a syringe with conical nozzle for manual suction, tube feeding or for gastric aspiration
Can also be used with pump, suction, foot operated (anaesthesia) or suction machine
A bi-conical connector is required to connect to suction tubes (CONNECTOR, bi-conical, symmetric. ext dia. 7 to 11 mm autocl.)
Packaging: Must be supplied in sterile peel pack packaging
Labeling should mention: name and/or trademark of the manufacturer, sterile, lot number, expiry date by year and month, "for single use", CE + number; product description, instruction for use

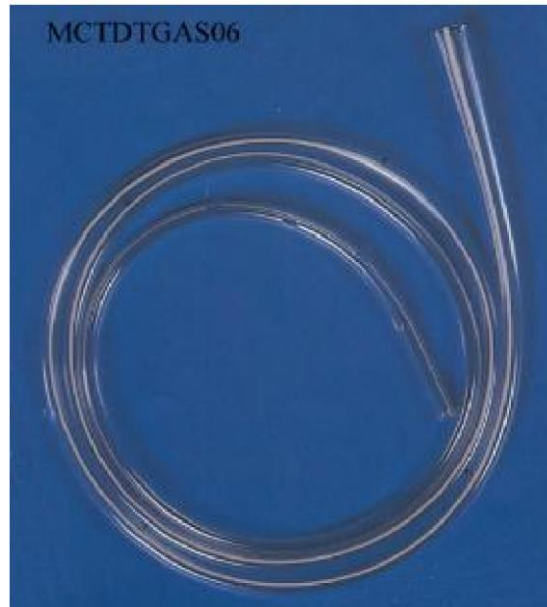

1604 TUBE, GASTRIC, CH 08, conical tip, 120cm, sterile, disp.

Tube with single channel

Proximal end has a connector for connecting to aspiration system

Material: Polyvinyl chloride (PVC)

Tube has radio-opaque markings at 40, 50, 60 and 70cm from distal end corresponding to: cardia, stomach, duodenum, jejunum

Conical tip

Can be used with a syringe with conical nozzle for manual suction, tube feeding or for gastric aspiration

Can also be used with pump, suction, foot operated (anaesthesia) or suction machine

A bi-conical connector is required to connect to suction tubes (CONNECTOR, bi-conical, symmetric. ext dia. 7 to 11 mm autocl.)

Packaging: Must be supplied in sterile peel pack packaging

Labeling should mention: name and/or trademark of the manufacturer, sterile, lot number, expiry date by year and month, "for single use", CE + number; product description, instruction for use

1605 TUBE, GASTRIC, CH 10, conical tip, 120cm, sterile, disp.

Tube with single channel

Proximal end has a connector for connecting to aspiration system

Material: Polyvinyl chloride (PVC)

Tube has radio-opaque markings at 40, 50, 60 and 70cm from distal end corresponding to: cardia, stomach, duodenum, jejunum

Conical tip

Can be used with a syringe with conical nozzle for manual suction, tube feeding or for gastric aspiration

Can also be used with pump, suction, foot operated (anaesthesia) or suction machine

A bi-conical connector is required to connect to suction tubes (CONNECTOR, bi-conical, symmetric. ext dia. 7 to 11 mm autocl.)

Packaging: Must be supplied in sterile peel pack packaging

Labeling should mention: name and/or trademark of the manufacturer, sterile, lot number, expiry date by year and month, "for single use", CE + number; product description,

instruction for use

1606 TUBE, GASTRIC, CH 12, conical tip, 120cm, sterile, disp.

Tube with single channel
Proximal end has a connector for connecting to aspiration system
Material: Polyvinyl chloride (PVC)
Tube has radio-opaque markings at 40, 50, 60 and 70cm from distal end corresponding to: cardia, stomach, duodenum, jejunum
Conical tip
Can be used with a syringe with conical nozzle for manual suction, tube feeding or for gastric aspiration
Can also be used with pump, suction, foot operated (anaesthesia) or suction machine
A bi-conical connector is required to connect to suction tubes (CONNECTOR, bi-conical, symmetric. ext dia. 7 to 11 mm autocl.)
Packaging: Must be supplied in sterile peel pack packaging
Labeling should mention: name and/or trademark of the manufacturer, sterile, lot number, expiry date by year and month, "for single use", CE + number; product description, instruction for use

1607 TUBE, GASTRIC, CH 16, conical tip, 120cm, sterile, disp.

Tube with single channel
Proximal end has a connector for connecting to aspiration system
Material: Polyvinyl chloride (PVC)
Tube has radio-opaque markings at 40, 50, 60 and 70cm from distal end corresponding to: cardia, stomach, duodenum, jejunum
Conical tip
Can be used with a syringe with conical nozzle for manual suction, tube feeding or for gastric aspiration
Can also be used with pump, suction, foot operated (anaesthesia) or suction machine
A bi-conical connector is required to connect to suction tubes (CONNECTOR, bi-conical, symmetric. ext dia. 7 to 11 mm autocl.)
Packaging: Must be supplied in sterile peel pack packaging
Labeling should mention: name and/or trademark of the manufacturer, sterile, lot number, expiry date by year and month, "for single use", CE + number; product description, instruction for use

1608 TUBE, GUEDEL, airways, No 0, baby, autoclavable

To keep clear airway by preventing blockage by the tongue
Material: Polyethylene/ethylene vinyl acetate (EVA), Polyvinyl chloride (PVC), siliconized
The oropharyngeal airway has a curved, flattened part with an oval aperture
Semi-rigid, transparent, colourless, autoclavable
Size: N°0 pediatric, length: 50mm, inner Ø: 3.5mm
The distal end (i.e. the pharyngeal extremity) is curved with soft rounded edge
The proximal end (i.e. the buccal extremity) is straight and reinforced
The flange of the airway must be marked with a number corresponding to its size
Unit presentation: one Guedel tube, not sterile, reusable

1609 TUBE, GUEDEL, airways, No 00, neonate, autoclavable

To keep clear airway by preventing blockage by the tongue
Material: Polyethylene/ethylene vinyl acetate (EVA), Polyvinyl chloride (PVC), siliconized
The oropharyngeal airway has a curved, flattened part with an oval aperture
Semi-rigid, transparent, colourless, autoclavable
Size: N°00 neo-natal, length: 40mm, inner Ø: 3.0mm
The distal end (i.e. the pharyngeal extremity) is curved with soft rounded edge
The proximal end (i.e. the buccal extremity) is straight and reinforced
The flange of the airway must be marked with a number corresponding to its size
Unit presentation: one Guedel tube, not sterile, reusable

1610 TUBE, GUEDEL, airways, No 1, child, autoclavable

To keep clear airway by preventing blockage by the tongue
Material: Polyethylene/ethylene vinyl acetate (EVA), Polyvinyl chloride (PVC), siliconized
The oropharyngeal airway has a curved, flattened part with an oval aperture
Semi-rigid, transparent, colourless, autoclavable
Size: N°1 child, length: 60mm, inner Ø: 4.0mm
The distal end (i.e. the pharyngeal extremity) is curved with soft rounded edge
The proximal end (i.e. the buccal extremity) is straight and reinforced
The flange of the airway must be marked with a number corresponding to its size
Unit presentation: one Guedel tube, not sterile, reusable

1611 TUBE, GUEDEL, airways, No 2, adolescent, autoclavable

To keep clear airway by preventing blockage by the tongue
Material: Polyethylene/ethylene vinyl acetate (EVA), Polyvinyl chloride (PVC), siliconized
The oropharyngeal airway has a curved, flattened part with an oval aperture
Semi-rigid, transparent, colourless, autoclavable
Size: N°2 adolescent, length: 70mm, inner Ø: 4.0mm
The distal end (i.e. the pharyngeal extremity) is curved with soft rounded edge
The proximal end (i.e. the buccal extremity) is straight and reinforced
The flange of the airway must be marked with a number corresponding to its size
Unit presentation: one Guedel tube, not sterile, reusable

1612 TUBE, GUEDEL, airways, No 3, adult small, autoclavable

To keep clear airway by preventing blockage by the tongue
Material: Polyethylene/ethylene vinyl acetate (EVA), Polyvinyl chloride (PVC), siliconized
The oropharyngeal airway has a curved, flattened part with an oval aperture
Semi-rigid, transparent, colourless, autoclavable
Size: N°3 adult small, length: 80mm, inner Ø: 4.5mm
The distal end (i.e. the pharyngeal extremity) is curved with soft rounded edge
The proximal end (i.e. the buccal extremity) is straight and reinforced
The flange of the airway must be marked with a number corresponding to its size
Unit presentation: one Guedel tube, not sterile, reusable

1613 TUBE, GUEDEL, airways, No 4, adult, autoclavable

To keep clear airway by preventing blockage by the tongue
Material: Polyethylene/ethylene vinyl acetate (EVA), Polyvinyl chloride (PVC), siliconized

The oropharyngeal airway has a curved, flattened part with an oval aperture
Semi-rigid, transparent, colourless, autoclavable
Size: N°4 adult, length: 80mm, inner Ø: 4.5mm
The distal end (i.e. the pharyngeal extremity) is curved with soft rounded edge
The proximal end (i.e. the buccal extremity) is straight and reinforced
The flange of the airway must be marked with a number corresponding to its size
Unit presentation: one Guedel tube, not sterile, reusable

1614 TUBE, GUEDEL, airways, No 5, adult large, autoclavable

To keep clear airway by preventing blockage by the tongue
Material: Polyethylene/ethylene vinyl acetate (EVA), Polyvinyl chloride (PVC), siliconized
The oropharyngeal airway has a curved, flattened part with an oval aperture
Semi-rigid, transparent, colourless, autoclavable
Size: N°5 adult large, length: 100 mm, inner Ø: 5.0 mm
The distal end (i.e. the pharyngeal extremity) is curved with soft rounded edge
The proximal end (i.e. the buccal extremity) is straight and reinforced
The flange of the airway must be marked with a number corresponding to its size
Unit presentation: one Guedel tube, not sterile, reusable



ood1615 TUBE, rectal, CH 22, disposable

Material: transparent PVC
Length: 40 mm
Closed round tip
2 eyes



1616 TUBE, rectal, CH 26, disposable

Material: transparent PVC
Length: 40 mm
Closed round tip
2 eyes

1617 TUBE, SUCTION, CH 08, 51 cm, straight, sterile, disposable

Single channel translucent tube fitted with conical connection
Material: Polyvinyl chloride (PVC)
Distal end: open, straight (may be slanting or conical), with side openings, 2 lateral windows
Proximal end: fitted with a conical connector, enabling tube to be connected to a source of vacuum (syringe with conical end, suction device etc.)
Packaging: must be supplied in sterilized peel pack
Labeling should mention: name and/or trademark of the manufacturer, sterile, lot number, expiry date by year and month, "for single use", CE + number; product description, instruction for use
Other requirements: should conform to ISO standard

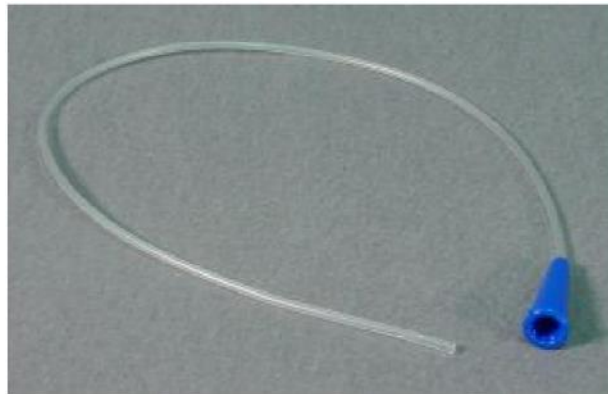

1618 TUBE, SUCTION, CH 10, 53 cm, straight, sterile, disposable

Single channel translucent tube fitted with conical connection
Material: Polyvinyl chloride (PVC)
Distal end: open, straight (may be slanting or conical), with side openings, 2 lateral windows
Proximal end: fitted with a conical connector, enabling tube to be connected to a source of vacuum (syringe with conical end, suction device etc.)
Packaging: must be supplied in sterilized peel pack
Labeling should mention: name and/or trademark of the manufacturer, sterile, lot number, expiry date by year and month, "for single use", CE + number; product description, instruction for use
Other requirements: should conform to ISO standard

1619 TUBE, SUCTION, CH 12, 51 cm, straight, sterile, disposable

Single channel translucent tube fitted with conical connection
Material: Polyvinyl chloride (PVC)
Distal end: open, straight (may be slanting or conical), with side openings, 2 lateral windows
Proximal end: fitted with a conical connector, enabling tube to be connected to a source of vacuum (syringe with conical end, suction device etc.)
Packaging: must be supplied in sterilized peel pack
Labeling should mention: name and/or trademark of the manufacturer, sterile, lot number,

expiry date by year and month, "for single use", CE + number; product description, instruction for use

Other requirements: should conform to ISO standard

1620 TUBE, SUCTION, CH 14, 53 cm, straight, sterile, disposable

Single channel translucent tube fitted with conical connection

Material: Polyvinyl chloride (PVC)

Distal end: open, straight (may be slanting or conical), with side openings, 2 lateral windows

Proximal end: fitted with a conical connector, enabling tube to be connected to a source of vacuum (syringe with conical end, suction device etc.)

Packaging: must be supplied in sterilized peel pack

Labeling should mention: name and/or trademark of the manufacturer, sterile, lot number, expiry date by year and month, "for single use", CE + number; product description, instruction for use

Other requirements: should conform to ISO standard

1621 TUBE, SURGICAL SUCTION PUMP, 10 mm diam, silicone, autoc., 10 m

To fit to the electric suction pump

Should not collapse due to vacuum

External diameter approx 10 mm

Internal diameter: 6 mm

Length 10 m

To be used with: CONNECTOR, fingertip
SUCTION UNIT, electric, 1 bottle, 1 ltr, autoclavable



1622 TUBE, SURGICAL SUCTION PUMP, 15 mm diam, silicone, autocl., 10 m

To fit to the electric suction pump

Should not collapse due to vacuum

External diameter approx 10 mm

Internal diameter: 11 mm

Length 10 m

To be used with: CONNECTOR, fingertip
SUCTION UNIT, surgical, electric, 2 bottles 5 ltr, complete

1623 TUBE, WENDL, NASOPHARYNGEAL airway, No 18

Nasopharyngeal airway, Wendl pattern,
With adjustable flange
Size: CH 18
Material: Latex-free
Packaging: sterile, individual packing for single use



1624 TUBE, WENDL, NASOPHARYNGEAL airway, No 22

Nasopharyngeal airway, Wendl pattern,
With adjustable flange
Size: CH 22
Material: Latex-free
Packaging: sterile, individual packing for single use

1625 TUBE, WENDL, NASOPHARYNGEAL airway, No 24

Nasopharyngeal airway, Wendl pattern,
With adjustable flange
Size: CH 24
Material: Latex-free
Packaging: sterile, individual packing for single use

1626 TUBE, with swab transport medium, sterile

Used to transport bacterial specimen to a referral laboratory for diagnostic confirmation and bacterial sensitivity test

Transport medium preserves aerobic bacteria present in the sample

Components:

- Tube with adhesive label
- Swab
- Transport medium

Material:

- Tube: Polypropylene
- Swab: Cotton tip on wooden or PP stick
- Transport medium: "Amies" agar gel semi-solid agar

Sterile, single use only

Storage: keep between 2-8°C

Packaging: must be supplied in sterilised peel pack
Labeling should mention: name and/or trademark of the manufacturer, sterile, lot number, expiry date by year and month, "for single use". CE + number, product description, instruction for use



1627 TUNIC, SURGICAL, reusable, cotton, size L

Tear proof tunic with low and cut-out neck, flat side pockets with rounded corners and short sleeves

Material: woven cotton 100%

Weight per m2: minimum 145 g

Colour: blue or green

Size L:

- Length: 73 cm

- Chest measurement: 102-105 cm

Washing: normal, withstands boiling and autoclaving, resists to chlorine 0.5%

Packaging: protected in a plastic bag, single or multiple unit



1628 TUNIC, SURGICAL, reusable, cotton, size M

Tear proof tunic with low and cut-out neck, flat side pockets with rounded corners and short

sleeves
Material: woven cotton 100%
Weight per m2: minimum 145 g
Colour: blue or green
Size M:
- Length: 69 cm
- Chest measurement: 93-97 cm
Washing: normal, withstands boiling and autoclaving, resists to chlorine 0.5%
Packaging: protected in a plastic bag, single or multiple unit

1629 TUNIC, SURGICAL, reusable, cotton, size S

Tear proof tunic with low and cut-out neck, flat side pockets with rounded corners and short sleeves
Material: woven cotton 100%
Weight per m2: minimum 145 g
Colour: blue or green
Size S:
- Length: 64 cm
- Chest measurement: 82-85 cm
Washing: normal, withstands boiling and autoclaving, resists to chlorine 0.5%
Packaging: protected in a plastic bag, single or multiple unit

1630 TUNIC, SURGICAL, reusable, cotton, size XL

Tear proof tunic with low and cut-out neck, flat side pockets with rounded corners and short sleeves
Material: woven cotton 100%
Weight per m2: minimum 145 g
Colour: blue or green
Size XL:
- Length: 77 cm
- Chest measurement: 110-115 cm
Washing: normal, withstands boiling and autoclaving, resists to chlorine 0.5%
Packaging: protected in a plastic bag, single or multiple unit

1631 ULTRA SOUND BASIC UNIT, with convex probe 3.5 Mhz

Portable appliance for diagnostic imaging in obstetrics, gynaecology, paediatrics and general surgery
High performance, heavy duty, portable ultrasound system main unit
Compact, lightweight and easy to carry
- Size approx: W 29 x H 32 x D 25 cm
- Weight: 10 kg
Monitor with screen: uncomplicated controls, straight forward operation
Scanning method: electronic convex sector, electronic linear
Imaging display modes: B, dual B, M, B and M
Imaging technologies: dynamic frequency imaging, multi-stage focusing, aperture control
Image grey-scale: 64 levels
Depth range selection: convex sector image and linear image, 3 steps
Image orientation: lateral and vertical inversion (in B mode) measurement and analysis
Caliber control: trackball
On B-mode image: distance, area and circumference by ellipse or trace method, volume,

ratio, gestational age, fetal weight, angle
Gestational table: user programmable
On M-mode: velocity, time interval, depth, heart rate, LV function
Characters and graphics:
- Patient information, annotation area, body mark display
Automatic display:
- Date and time, focal point setting, image orientation mark, image scrolled position, distance scale mark
- M-mode time mark, grey scale for calibration
- Automatic display selectable On / Off: gain setting, near gain setting, far gain setting, probe frequency, puncture guide line
Viewing monitor: 7-inch diagonal monitor with non-reflexion filter
Video output: 625 lines / frame
To be supplied with: 1 electronic convex sector probe, standard (frequency 3.5 MHz, scanning angle 60°, radius 60 mm)
1 Linear probe, paediatrics (frequency 5 MHz, scanning wide 64 mm)
1 Foot switch for freezing picture
1 Video printer
10 rolls of spare paper
1 Trolley on castors
1 Ultrasonic gel 5 L canister
1 Dispenser for Ultrasonic gel
Environmental requirements:
- In operation: temperature -10 to +40°C, relative humidity (30 to 85% non condensing)
- In storage: temperature -10 to +50°C, relative humidity (10 to 90 % non condensing)
Other requirements: meets WHO specifications concerning EUG (ultrasound for general use)
In conformity with Council Directive 93/42/EEC on Medical Devices and have a CE + Nr marking
Complies with IEC 601-1 Class1, type BF

1632 **UNDERPAD, SHEET, disposable**

Used to protect the bed linen from body fluids
Like 'Moltex Molinea'
With rubber-like surface on the lower part, waterproof
Fleece layers (8 layers) on the top
Size: 60 x 90 cm
Liquid absorption: 1590ml ± 10%
Disposable, non sterile
Packaging: carton, no. of units displayed on packaging

1633 **URINAL, male, 1 liter, plastic, with lid, autoclavable**

Container to collect urine from male patient confined in bed
Transparent vessel, neck shaped, with lid
Volume up to 1000 ml, 100 ml graduation
Autoclavable up to 130°C
Material: Polycarbonate



1634 VACUUM EXTRACTOR, OBSTETRICAL, manual

An alternative to obstetric forceps, only for experienced medical personnel

Manual vacuum extractor with suction cups by Malmström

Hand-operated pump

Must be easy to use and to assemble

Can be totally disassembled, is easy to clean, disinfect and sterilize

All parts autoclaved at 121°C-134°C, except basket

All parts manufactured from high-strength, long-life materials and require no special maintenance or storage conditions

Consisting of:

- 1 Suction cup 40mm opening diameter, complete with traction handle, stainless steel
- 1 Suction cup 50mm opening diameter, complete with traction handle, stainless steel
- 1 Suction cup 60mm opening diameter, complete with traction handle, stainless steel
- 1 Vacuum pump hand-operated, stainless steel with valve membrane and washer
- 1 Rubber plug with 3 holes for vacuum gauge and connector angles
- 1 Connector angle, stainless steel
- 1 Connector angle with screw valve, stainless steel screw cap and gasket
- 1 Vacuum gauge (bar/in Hg -0/-1.0, 0/-30) with straight connector, stainless steel
- 1 Vacuum bottle, glass
- 1 covered basket, plastic, for bottle
- 1 Tube, silicone transparent (OD 11 mm I D 6 mm) (L) 50cm for pump

Other requirements: must be in conformity with Council Directive 93/42/EEC on Medical Devices and have CE Marking

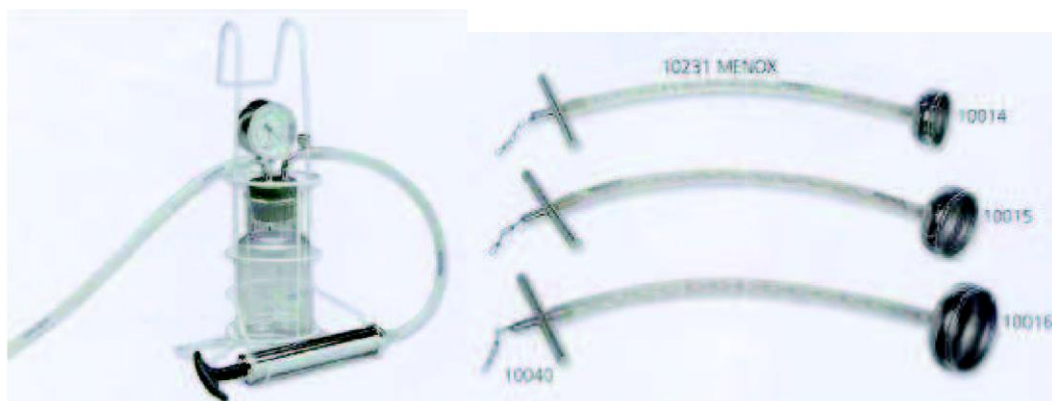

1635 VASELINE

Vaseline is used to seal the cover slip air tight on the slide with the blood mixture to examine sickle cells

100% vaseline according German Pharmacopoeia 7

Packaging: plastic container or tube

1636 WALL VIEWER, X-RAY FILMS, 50 x 78cm, complete

X-ray wall viewer or wall X-ray illumination, used to visualise developed X-ray film in X-ray department or operation theatre

Cabinet body

Wall mounting: rear panel has keyhole opening for toggle bolts

Material:

- Extruded PVC and injection-moulded ABS, rear panel in epoxy coated steel (10/10)

Light source:

- 4 straight daylight fluorescent tubes 15 W
- colour temperature: 6500 Kelvin
- Light intensity: uniform central point 3000 Cd/m² (comply with EN 6586)
- minimum: 1300 Cd/m³
- Colour temperature tubes: 3600 - 4000°Kelvin minimum
- fluorescent "daylight" type

Light control: ON/OFF switch with lighted indicator or by shielded dimmer for variable intensity

Diffusing panel:

- Viewing area: approx. 76 x 45 cm (Minimum: 72 x 43 cm)
- Material: screen cast acrylic sheet (Plexiglass), white opal/ semi-translucent
- 3 mm thickness.

Sliding clip: transversal, adjustable by cursor for film support

Nylon wire

Film grip:

- with a band of colour
- Material: chromed metal roller

Base trip: holds films at base

Power supply cable: standard, 2 poles + ground, at least 2 m long

Dimensions:

- External dimension: L/H/D: approx. 78 x 50 x 11 cm (Minimum: 75.5 x 51 x 11 cm)

Other requirements: Electrical component conform to EN 60598-1 and 60601-1,2



1638 WARMER, FEEDING BOTTLE, electric

A portable baby bottle warmer that will safely warm bottles and baby food
Thermostatically controlled
For standard and wide neck bottles and containers of baby food
Other requirements: conforms to BS EN 60335-2-15

1639 WATCH GLASS DISH

Circular, slightly convex-concave piece of glass used as a surface to evaporate a liquid, to hold solids while being weighed, or as a cover for a beaker
Diameter: 5 cm
Packaging: protective bubble foil



1640 WEIGHT FOR HEIGHT TABLE

Screening table, indicating height and weight relationship
To be put up on the wall
Unicef/WHO standard

1641 WHEELCHAIR, foldable, adult size with solid tyres

Frame constructed from chrome-plated steel tube
Seat and back in reinforced nylontex
With armrests
Detachable clothes guards
Detachable folding footplates
Solid tyred rear propelling wheels, \varnothing 570 mm
Solid tyred castors wheels, \varnothing 210 mm
Seat width: 450 mm
Seat depth: 400 mm
Weight Capacity: 150 Kg

1643 WHITE BOARD, approx. 110 x 70 cm

Dry erase reusable writing surface
Full-length marker rail on bottom side with protective plastic end caps
Lightweight construction
To be used with: MARKER, for white board, various colours



1644 CLOTH, Microfibre, for surface cleaning

Safe to use and highly effective on all surfaces
Washable up to 300 times at temperatures up to 90°C
Size: approx. 30 x 50 cm

1645 WIRE, KIRSCHNER, 1.60 mm x 310 mm

1646 WIRE, KIRSCHNER, 2.00 mm x 310 mm, double trocar point

1647 X-RAY CASSETTE HOLDER, floor stand

Cassette holder for upright patient examination for cassettes up to a length of 50 cm
Adjustable height of the cassette position
Free standing
Dismountable construction



1649 X-RAY UNIT, BASIC, MOBILE, 40 mA

Basic mobile X-ray unit used in emergency situation and in field hospital
For extremities and chest X-Rays
Like: Siemens POLIMOBIL III
A simple procedure allows the unit to be easily assembled/disassembled by non-technical

staff

The operating console and the X-ray tube can be removed from the mobile base

X-Ray generator and Controls:

Main voltage:

- 230V+/-10% 50/60 Hz, fuse 10 A
- 110V+/-10% 50/60 Hz, fuse 15 A

Internal line impedance: Max. 0.9 ohms at 230 V

Max. 0.3 ohms at 110 V

Output: 2.5 kW (according to EN /DIN 6822)

Wave shape: Multi pulse, max 5kV ripple

KV range: 40-100 kV in 21 steps

mA-range: 25-40mA

mAs-range: 0.32-200 mAs in 29 steps

- 0.5-200mAs at 40 kV
- 0.4-125mAs at 52-57 kV
- 0.32-125mAs at 60-63 kV
- 0.32-100mAs at 66-77 kV
- 0.32-80mAs at 81 -1 00kV

Shortest exposure time: 8 ms

Max exposure time: 5 s

Length of power cord: approx 5 m

Tube housing assembly

Working conditions:

- Temperature: +10° to ° 40°
- Humidity 30 to 80%
- Atmospheric pressure: 700hPa to 1060hPa

Warranty:

- For 12 months from the date of installation or 15 months from the invoice date, whichever comes first

Transport and storage

- Temperature: -20°C to + 70°C
- Humidity 10 to 100%
- Atmospheric pressure: 500hPa to 1060hPa

Total net weight: approx 142.00kg

Packaging: Wooden crate

Other requirements: conform to EN 60601-1 and EN 60529

To be supplied with: 2 sets of spare fuses



1650 ALARM CLOCK analog, 1min-60min

Mechanical timer with ringer for timing staining techniques, biochemistry tests etc
Interval 1 to 60 minutes



1651 (d.redon) NEEDLE, CH 14, straight, bent tip, autocl., reus.

To insert the drain into the body
Material: stainless steel
19 cm long
Distal end: triangular point for insertion
Threaded proximal end to attach the drain
Non sterile, autoclavable

1652 BLOOD BAG, CPD Adenine, 250 ml, simple

For collecting blood from the donor, storage and transfusion (using a blood giving set)

With blood sample plug

Material: Di-ethylhexyl phthalate (DEHP) plasticized PVC

Volume of CPDA per bag: 35 ml / 250 ml

Blank label for essential data

Sterile

Packaging:

- Sterile sets in aluminium foil
- Airtight wrapping
- Protection against light

Labeling:

- Type and quantity of anti-coagulant
- Capacity of bag
- Expiry date and batch number

To be used with: BLOOD GIVING SET (transfusion)

Other requirements: Conforms to ISO 3826



1653 (dermatome, electric) BLADE

sterile

To be used with: DERMATOME, electric, complete set

1654 SET, SKIN GRAFT MESHER, incl. mesh carriers, various sizes

Components:

- feed roller
- cutting roller
- guidance plateau
- ratchet handle
- Allen wrench
- stainless steel case

Can be sterilized

To be supplied with: 1 x Mesh carrier 1,5:1
2 x Mesh carrier 3:1
2 x Mesh carrier 6:1
1 x Mesh carrier 9:1

To be used with: DERMATOME, electric, complete set

1655 CONNECTOR, fingertip

Used for fingertip control of the suction drainage flow of residues and fluids

To be used with: TUBE, SURGICAL SUCTION PUMP, 10 mm diam, silicone, autoclavable, 10 m
TUBE, SUCTION, CH various, 51 cm, straight, sterile, disposable



1656 TEAT, PIPETTE FILLER, rubber, for pipettes up to 10 ml

Rubber ball which is fitted to a glass pipette in to draw fluid
Suitable for up to 10 ml glass pipettes



2000 X-RAY FILM, 24 cm x 30 cm, blue sensitive

X-ray film, blue sensitive, normal sensitivity and high contrast, can be used for manual development and with 90- second machine processing

Packaging:

- 100 sheets/box
- In accordance with IATA rules
- Clear and explicit instructions on the label as well as expiry date and storage conditions

2001 X-RAY FILM, 30 cm x 40 cm, blue sensitive

X-ray film, blue sensitive, normal sensitivity and high contrast, can be used for manual development and with 90- second machine processing

Packaging:

- 100 sheets/box
- In accordance with IATA rules
- Clear and explicit instructions on the label as well as expiry date and storage conditions

2002 X-RAY FILM, 35 cm x 43 cm, blue sensitive

X-ray film, blue sensitive, normal sensitivity and high contrast, can be used for manual development and with 90- second machine processing

Packaging:

- 100 sheets/box
- In accordance with IATA rules
- Clear and explicit instructions on the label as well as expiry date and storage conditions

3000 ASL-Titre complete with pos.& neg. control

Principle of Latex test to detect or semi-quantify Antistreptolysin O in human serum by means of particle-enhanced rapid screening test

Components:

- Suspension of polystyrene particles coated with streptolysin 0,6 ml

- Positive control 0,5 ml and negative control 0,5 ml
- test plate, black

Storage: Cold chain, keep refrigerated between 2-8°C

Do NOT freeze

Expiry date is printed on the bottle label

3001 CRP Rapid test

The CRP test is a 2-minute Point of Care test to indicate bacterial or viral cause of infection
CRP measures C-reactive protein (CRP), an acute phase protein that increases rapidly after onset of infection

The kit consists of reagents, reaction containers, CRP test cards and colour template

Expiry date is printed on the test kit

3002 HEPATITIS B TEST, rapid

Qualitative rapid test for detecting the hepatitis B surface antigen

Principle is based on a sandwich immune-chromatographic technique

Used for screening blood donors

Components:

- 20 devices
- Case buffer: 2ml
- 20 pipettes
- One step test

Reaction time ± 10 min

Can be performed on serum, plasma and whole blood

Sensitivity 99%

Specificity: 100%

Internal control included

Storage: At room temperature

Expiry date is printed on the test kit

3003 HEPATITIS C TEST

Qualitative rapid test for detecting antibodies against hepatitis C (HCV)

The test is using recombinant antigens derived from virus sequences

The presence of antibodies is revealed by the adjunction on the conjugate of which the linkage with the antibody on the antigen will create a red colouration on the membrane

Used for the screening of blood donors

Components:

- HCV single devices
- Non reactive control conjugate
- Weak reactive control conjugate
- Strong reactive control conjugate
- Diluents
- Blocking buffer
- Wash buffer 1 and 2
- Stop solution
- Sample pipettes
- Reagent pipettes

6 steps test with additional stages for reagents

The bottles with buffer, washing and stop solution are clearly identifiable

Internal control included

Sensitivity: 100%

Specificity: 93.7%

Storage:

No long exposure to heat

Unopened kit: store at coolest and driest area

Open kit: store between 2-8° C

The reconstituted controls remain stable for 6 months between 2-6°C and 1 month at room temperature

The reconstituted conjugates remain stable for 1 month between 2-8°C and 5 days at room temperature

Expiry date is printed on the test kit

3004 HIV TEST 1 + 2, rapid

Simple rapid qualitative test for detecting antibodies against HIV 1+2

Lateral migration test, based on sandwich immune-chromatographic technique

Used as confirmatory test

With buffer to test capillary blood

Single strips

Duration of procedure about 15 min

Antigen: recombinant proteins and synthetic peptides

Sensitivity: 100%

Specificity: 99.7%

Internal control included

Performance in whole blood, serum and plasma

Storage: No long exposure to heat, at room temperature (2 to 30° C)

Expiry date is printed on the test kit

3005 MALARIA P. FALCIPARUM TEST, rapid

Rapid, qualitative, two site sandwich immunoassay for the determination of P. falciparum specific histidine rich protein - 2 (Pf. HRP-2) in whole blood samples

Components:

Buffer

Test strip

Rapid test: 15 – 20 min

Storage: +2 to +30° C, do not freeze

Important: When transporting or storing the packages, avoid exposure to high temperatures (over +40 C) for a period longer than 1 day

Avoid any exposure to +60 C and higher (the reagent may be damaged)

Expiry date is printed on the test kit

3006 PREGNANCY TEST

One step rapid qualitative test for detecting the HCG pregnancy hormone (human chorionic gonadotrophin) in urine

Single trope

Minimal sensitivity: 25 mIU/ml

Test without any additional reagent

Storage: 15 – 25° C

Expiry date is printed on the test kit

3007 SYPHILIS RPR TEST (carbon test)

Rapid non-treponemic test for detection of syphilis
RPR (Rapid Plasma Reagin) test using a VDRL antigen combined with carbon particles
Used for screening of blood donors

Components:

- Antigen VDRL carbon
- Positive and negative controls
- Dropper bottle and needle
- Reaction cards for manual reading

Sensitivity 70-80%

Storage: Cold chain; keep refrigerated between 2-8° C, do NOT freeze

Expiry date is printed on the test kit

3008 URINE TEST, 1 strip, Leu/ni/pH/prot/gluc/ket/urobi/bili/blood

Test used for determination of 9 parameters in urine: leucocytes, nitrites, pH, protein, glucose, ketone, urobilinogen, bilirubin and blood/haemoglobin

Components:

- Plastic box with 9 colorimetric charts
- Disposable strips

Each strip with 9 reactive pads which change color according to the concentration of substances in urine

Colorimetric chart giving semi-quantitative results: -, ±, +, ++, +++, +++++, mmol/l and mg/dl

Storage: At room temperature (2- 30° C), protected from light and humidity

Expiry date is printed on the box

3009 URINE TEST, 1 strip, prot/gluc/pH

Test used for determination of 3 parameters in urine: protein, glucose and pH

Components:

- Plastic box with 9 colorimetric charts
- Disposable strips

Each strip with 9 reactive pads which change color according to the concentration of substances in urine

Colorimetric chart giving semi-quantitative results: -, ±, +, ++, +++, +++++, mmol/l and mg/dl

Storage: At room temperature (2- 30° C), protected from light and humidity

Expiry date is printed on the box

3010 PANDY'S REAGENT (Protein in Liquor)

Used to examine protein in CSF

Dangerous Goods Regulations (DGR):

Phenol solution

Clear colorless liquid

T=Toxic substance

Risk statements: R24/25-34

Safety statements: S26/36/37/38/45

Storage: tightly closed bottle, well ventilated area and cool storage (< 15°C)

Packaging: glass or plastic bottle, protective wrapping

Packaging class VCI 6.1

Packing group II, instruction 6.1 JATA

3011 BUFFER, pH 7.2, 1 tab./1000ml

Used to dilute staining solutions e.g. Giemsa Stain for haematological staining (blood smears) and for blood parasitology (malaria smears)
Packaging: container with 100 tablets

3012 ETHANOL 99%, denatured with 1% MEK p.A.

Alcohol used to prepare certain reagents
Coloured liquid

Dangerous Goods Regulations (DGR):

Risk statements: R11

Safety statements: S7/16

Packaging:

- 1 litre glass or plastic bottle
- Packing group II
- Instructions 305 (JATA) JATA UN1170
- IMDG 3.2/II
- ADR 3/3b

Labeling:

- Identification label in English with the number UN1170
- Handling label should indicate 'up', 'down' in black writing (minimum 74 x 105 mm) on the sides
- Primary danger label, class 8 label 'Corrosive 8' (minimum 100 x100 mm) on one side
- Secondary danger label, class 3 'flammable liquid 3', (minimum 100 x 100 mm) on one side

3013 GIEMSA solution

The Giemsa solution should always be diluted (in buffered water pH 7,2) to stain thick and thin blood films

Dangerous Goods Regulations (DGR):

- F=Highly flammable substance
- T=Toxic substance
- Risk statements: R11/23/24/25/39
- Safety statements: S3/9/16/28/33/35/36/37/45

Rapid stain solution

Giemsa (improved recipe azure 1) glycol, Methanol

Storage: Protected from light and humidity

Expiry date on the bottle

Packaging: in 500 ml bottle, plastic or glass

- Packaging group II
- Instructions 305 (JATA)
- JATA UN992
- IMDG 3.2/II
- ADR 3/19b

3014 GRAM COLOR, complete staining set (500ml)

Gram color staining set is used to stain bacteria. Most bacteria can be distinguished by their gram reaction, due to differences in their cell wall structure in two groups: gram positive

bacteria are stained deep violet; Gram negative bacteria are stained red
Like 'Merck No. 1118850001'

This gram color staining set includes 4 different chemicals ready-to-use solutions for Gram stain:

- S1 Oxalate violet crystal
- S2 Lugol's Iodine
- S3 (+4 depends on company) Decolorizing agent (ethanol)
- S5 Safranine

Dangerous Goods Regulations (DGR):

- Xi=Irritant substance
- F=Highly flammable substance
- Risk statements: R11/40
- Safety statements: S3/9/16/33/35/36/37

Packing group II: Instructions 305 (JATA)
JATA UN1993
IMDG 3,2/II
ADR3/3b

Labeling: Identification label in English 'ethanol' and the number UN1170
Handling label should indicate 'up', 'down' in black writing (minimum 74x105 mm) on two opposite sides
Primary danger label, class 3; 'Flammable liquid 3' (minimum 100 x 100 mm) on one side
Secondary danger label class 6.1 'Toxic' (minimum 100 x 100 mm) on one side

Expiry date on the bottle

3015 HYDROCHLORIC ACID,1N

HCl-standard volumetric solution

1 mol/L (1 N Solution)

Clear colorless liquid

Category of danger irritant, slightly polluting substance

Risk statements: R36/37/38

Safety statements: S26

Storage class (VCI) 8B non flammable corrosive material

Packing and transport:

- Packaging group: III
- Air transport ICAO-TI and IATA-DGR:
- ICAO/IATA Class: 8
- UN/ID Number: 1789

3016 METHANOL pure Ph Eur

Used to fix smears and to prepare numerous reagents

The chosen quality ensures that smears are properly fixed

Dangerous Goods Regulations (DGR):

F=Highly flammable substance

T=Toxic substance

Risk statements: R11/23/24/25/39/23/24/25

Safety statements: S7/16/36/37/45

Specifications: Liquid

Concentration at least 98%

Quality: Pure

Storage: At room temperature

Packaging:

- 1 litre glass or plastic bottle
- Packaging group II
- Instructions 305 (JATA)
- JATA UN1230
- IMDG 3.2/II
- ADR 3/17b

Labeling:

- Identification label in English with the number UN1230
- Handling label should indicate 'up', 'down' in black writing (minimum 74 x 105 mm) on two opposite sides
- Primary danger label class 3 'flammable liquid 3', (minimum 100 x 100mm) on one side
- Secondary danger label, class 6.1: 'toxic' (minimum 100x100mm) on one side

3017 POTASSIUM HYDROXIDE, pellets, p.A.

Used for microscopically examination of specimens for dermatophytes (fungi) infection

Dangerous Goods Regulations (DGR):

C=Corrosive

Risk statements: R22/35

Safety statements: S26-36/37/39/45

Form: Solid.

Colour: Colourless

Storage: Tightly closed, dry

Packaging:

- Packing group II
- Instructions 814 (IATA).
- IATA UN1813
- IMDG 8/II
- ADR 8/II

Labeling:

- Identification label in English: 'corrosive' with the number UN1813
- Handling label should indicate 'up', 'down' in black writing (minimum 74x105 mm) on two 'opposite sides
- Primary danger label class 8: 'corrosive' (minimum 100x100mm) on one side

3018 TB COLOUR STAINING SET, complete

The Tb colour staining set is used to stain acid fast bacilli (TB-bacilli) in sputum specimen
When mycobacteria and Cryptosporidium oocysts are stained with hot strong fuchsin, they resist decolonization with a solution of acid or acid alcohol and stain red
This property is due to the presence of a waxy substance in the cell wall called mycolic acid
Everything else in the smear is decolorized by acid alcohol and demonstrated by the counter stain methylene blue

UN 2924

The TB-colour staining set consists of the following ready-to-use staining solutions:

- **Solution 1: 500 ml Carbol Fuchsin Solution**
- **Solution 2: 2 x 500 ml Hydrochloric Acid Alcohol**
- **Solution 3: 500 ml Methylene Blue Solution**

Quality for microscopy or bacteriology

Solution 1 (Carbol Fuchsin Solution):

Dangerous Goods Regulations (DGR):

- Xn Harmful substance
- Risk statements: R33
- Safety statements: S35

Packaging:

- In 500 ml brown glass bottles
- Packing group II
- Instructions 809 (JATA)
- JATA UN1789
- IMDG8/II
- ADR 8/5b

Labeling:

- Identification label in English with the number UN1789
- Handling Label should indicate 'up', 'down' in black writing (minimum 74 x 105mm) on two opposite sides

Solution 2 (Hydrochloric Acid Alcohol):

Dangerous Goods Regulations (DGR):

- C= corrosive substance
- Risk statements: R34/37
- Safety statements: S26/45

Packaging:

- In 500 ml brown glass bottles
- Packing group II
- Instructions 809 (JATA)
- JATA UN1789
- IMDG8/II
- ADR 8/5b

Labeling:

- Identification label in English with the number UN1789
- Handling Label should indicate 'up', 'down' in black writing (minimum 74 x 105mm) on two opposite sides

Solution 3 (Methylene Blue Solution):

No Dangerous Good

Packaging: in 500 ml brown glass bottle

3019 FIELD STAIN A Colouring solution

Field stain A & B are used to prepare the staining solution to stain thick and thin blood films for Malaria parasites or differential count

Field Stain A (buffered Azure 1, Methylene Blue, Cl-) powder

Protected from humidity

Packaging: Plastic or glass bottle

Expiry date on the bottle

3020 FIELD STAIN B Colouring solution

Field stain A & B are used to prepare the staining solution to stain thick and thin blood films for Malaria parasites or differential count

Field Stain B (buffered Eosin, Cl-) powder

Protected from humidity

Packaging: Plastic or glass bottle

Expiry date on the bottle

3021 TURK SOLUTION, for wbc count

Turk solution is used to count white blood cells (leucocytes)
Blue-violet liquid
Storage: Tightly closed at room temperature
Expiry date printed on the bottle
Packaging: glass bottle

3022 TUBE, BLOOD COLLECTION, 2.7 ml, with EDTA, polystyrene

Sterile (inside) tube designed to contain blood for haematology tests and blood transfusion
Like 'Sarstedt Item No 05.1167'
Material: Polystyrene tube containing EDTA anticoagulant
Safe closed system
Non sterile, disposable
Expiry date printed on each tube
To be used with: (RefNo1080) BLOOD SAMPLING, MULTI-ADAPTOR Luer, for multiple sampling (Sarstedt Item No.14.1205)

3023 TUBE, BLOOD COLLECTION, 7,5 ml, Serum, polystyrene

Sterile (inside) tube designed to contain blood for haematology tests and blood transfusion
Like 'Sarstedt Item No 05.1167'
Material: Polystyrene tube
Safe closed system
Non sterile, disposable
Expiry date printed on each tube
To be used with: (RefNo1080) BLOOD SAMPLING, MULTI-ADAPTOR Luer, for multiple sampling (Sarstedt Item No.14.1205)

3024 BLOOD SUGAR TEST STRIP

Glucometer test strips use to determine the blood glucose level
Storage condition: independent from refrigerator also in high temperatures
To be used with: (RefNo 1262) GLUCOMETER, battery operated

3025 (haemoglobinometer like "HEMOCUE201+") CLEANER SWABS

To be used with: (RefNo 1269) HAEMOGLOBINOMETER like "HEMOCUE201+", with transformer

3026 (haemoglobinometer 'Hemocue201+') MICROCUVETTE

Cuvette used to measure haemoglobin
Material: Plastic
Specification: Disposable micro cuvette with dried reagent.
Single wrapped
Packaging: depends on supplier
To be used with: (RefNo 1269) HAEMOGLOBINOMETER like "HEMOCUE201+", with transformer

3027 TUBE FOR ESR, 3.5 ml, citrated

Like 'S-Sedivette' (Sarstedt Item No. 06.1690.001)
Graduated

To be used with: (RefNo 1413) RACK, ESR RATE (Sarstedt Item No. 90.1090)

3028 ANTI-HUMAN GLOBULIN, COOMBS, 10ml, btl.

Reagent used for the direct and indirect antiglobuline test (Coombs) to detect antibodies (compatibility testing, blood transfusion)

Polyspecific reagent for detection of IgG and complement binding blood group antibodies by the direct (DAT) and indirect (IAT) antiglobulin tests

Contains anti-human IgG and anti-human C3d

Green reagent

Conservative agent: Sodium azide

Storage: Cold chain, keep refrigerated between 2-8°C, do NOT freeze

Expiry date is printed on the bottle label

Packing: 10 ml dropper bottle for about 150 to 200 tests

3029 BOVINE ALBUMIN , 22%, 10ml, btl

Reagent used for the compatibility testing at 37°C blood transfusions

Conservative agent: Sodium azide

Colourless reagent

Storage: Keep refrigerated between 2-8°C, do NOT freeze

Expiry date is printed on the bottle label

Packing: 10 ml dropper bottle for about 150 - 200 tests

3030 BLOOD GROUPING SERUM ANTI-A, MONOCLONAL, 10ml, btl.

Reagent (antiserum) used for blood group typing

Together with the other anti-sera anti-B and anti-AB it detects the presence of antigen A

Consists of monoclonal antibodies

Conservative agent: Sodium azide

Blue reagent

Storage: Cold chain, keep refrigerated between 2-8° C, do NOT freeze

Expiry date is printed on the bottle label

Packing: 10 ml dropper bottle for about 150-200 tests

3031 BLOOD GROUPING SERUM ANTI-(A+B), MONOCLONAL, 10ml, btl.

Reagent (antiserum) used for the blood group typing

Together with the other anti-sera; anti-A and anti-B it detects the presence of antigens A and B

Consists of monoclonal antibodies

Conservative agent: sodium azide

Colourless reagent

Storage: Cold chain, keep refrigerated between 2-8° C, do NOT freeze

Expiry date is printed on the bottle label

Packing: 10 ml dropper bottle for about 150-200 tests

3032 BLOOD GROUPING SERUM ANTI-B, MONOCLONAL, 10ml, btl.

Reagent (antiserum) used for the blood group typing
Together with the other anti-sera; anti-A and anti-AB, it detects the presence of antigen B
Consists of monoclonal antibodies
Conservative agent: sodium azide
Yellow reagent
Storage: Cold chain, keep refrigerated between 2-8° C, do NOT freeze
Expiry date is printed on the bottle label
Packing: 10 ml dropper bottle for about 150-200 tests

3033 BLOOD RHESUS SERUM ANTI-D, IgM & IgG, 10ml, btl.

Reagent (antiserum) used for the blood group typing
Positive reaction with a drop of blood or red cells allows to detect the presence of antigen D
Components: Anti-D monoclonal Ig M & Ig G
Colourless reagent
Storage: Keep refrigerated between 2-8°C, do NOT freeze
Expiry date is printed on the bottle label
Packing: 10 ml dropper bottle for about 150 - 200 tests

3034 TEST FOR OCCULT BLOOD IN STOOL, Hemo FECÆ

Standard test to examine occult blood in stool specimen
Occult blood is one of the initial symptoms of intestinal cancer
Material: The package of hemo FECÆ consists of test slides and developer solution, containing H₂O₂ for the detection of occult blood in stool
It is a chromatographic guaiac test on occult blood
Qualitative test, results are obtained within 30 sec. after applying the developer solution
The result is in a blue quinone compound, detectable by visual examination
Packaging: 50 x 3 tests

3036 (analyser, dry chemistry, Reflotron), TESTSTRIPS BILIRUBINE

Dry chemistry to determine liver disease
Plastic strip with magnetic code to use exclusively for Reflotron
Packaging: 30 strips per unit
To be used with: (RefNo 1019) ANALYSER, DRY CHEMISTRY

3037 (analyser, dry chemistry, Reflotron), CREATININE TEST STRIPS

Dry chemistry to determine renal function
Plastic strip with magnetic code to use exclusively for Reflotron
Packaging: 30 strips per unit
To be used with: (RefNo 1019) ANALYSER, DRY CHEMISTRY

3038 (analyser, dry chemistry, Reflotron), TESTSTRIPS GOT

Dry chemistry to determine liver and heart disease
Plastic strip with magnetic code to use exclusively for Reflotron

Packaging: 30 strips per unit

To be used with: (RefNo 1019) ANALYSER, DRY CHEMISTRY

3039 (analyser, dry chemistry, Reflotron), TESTSTRIPS GPT

Specification Dry chemistry to determine liver disease

Material Plastic strip wit magnetic code to use exclusively for Reflotron

Packaging: 30 strips per unit

To be used with: (RefNo 1019) ANALYSER, DRY CHEMISTRY

3040 (analyser, dry chemistry, Reflotron), PRECINORM U

Universal Control sera for dry chemistry analyser

Control product consisting of lyophilized human sera with constituents added as required to obtain desired component levels

Material: lyophilized human sera

Universal control sera with normal levels

Package: bottle of 5 ml

To be used with: (RefNo 1019) ANALYSER, DRY CHEMISTRY

3041 BLOOD SUGAR CONTROL SERUM, bottle

Late expiry date: About 1 year

Storage condition: Independent from refrigerator

To be used with: (RefNo 1262) GLUCOMETER, battery operated

3042 FRAME FOR WASTE BAG, metal, with foot operated lid

Material: metal

Dimensions: approx. 490 x 460 x 800mm (Width x Depth x Height)

With foot operated lid

To be used with: BAG, PE plastic, for garbage, 60 L, black, 0.02mm



3043 NOTE PAD, A4, 50 sheet, ruled, white

3044 BLOOD SAMPLING, Multi-Sample Needle, G, 21G x 1 1/2

Material: Plastic

Safe blood collection system; single use

Packaging and labeling: each needle in sterile peel pack, should mention exp date, lot number, items description, size, type of sterilization, manufacturer name, ref number, CE + Nr, protective carton packing with same information and no. of units



3045 KIDNEY DISH, large, 275x150x45mm, stainless steel

Kidney shape, non-sterile

Length: 27,5 cm

Width: 15 cm

Depth: 4,5 cm



3046 CLIP BOARD, 35 x35 cm, patient record support, aluminium



3047 BEAKER, POLYPROPYLENE OR PMP, 100 ml

Graduated container to measure liquids
Material: Polypropylene or PMP (TPX)
Beaker low form, graduated

3048 GOWN, isolation, non-sterile, nonwoven, yellow, M

Protective clothing worn over a scrub shirt/trouser in order to have protection for moderate contact with fluids
Specifications/norms according to DIN EN 14126, ISO22610 and ISO22612

Technical specifications:

Nonwoven (SMS or SMMS [Spunbond-Meltblown-Spunbond])
Impervious supplementary protection layer (polyethylene film, nonwoven, etc.) in the critical zones (chest area and forearms)
Wraparound (not over the head)
Long sleeves
Cuffs made of elastic jersey
Latex-free

Dimensions:

Comes in 3 sizes: M/Universal, Large and XLarge

Length (shoulder seam to mid calf):

size M: ± 110 cm

size L: ± 136 cm

size XLarge: ± 145 cm



3048a GOWN, isolation, non-sterile, nonwoven, yellow, L

3049 GOWN, isolation, non-sterile, nonwoven, yellow, XL

Specifications according to 3048

3050 TABLE, X-RAY

Collapsible X-ray table for transportation, fixed height for various Digital Radiographic uses.
Table with laminated, radiolucent top, locking casters on front wheels, large wheels. Easy to

REF. DESCRIPTOR
Specification

clean and disinfectant proof. Patient Weight Capacity: 440 lbs (200kg)

Max. Size:
Max. Weight:



3051 PEDESTAL FAN, 230V, 40W

Material: metal and plastic
Fan diameter: approx. 40 cm
Height: 135 cm



3052 HANG HOOK, for ladders

Hang hook for ladders to hang e.g. buckets
Material: metal
Size: approx. 19,4 x 17 x 7,8 cm



3053 LADDER, multi-use, aluminium, 16 steps, 5m, w/ footstep

Material: aluminium
Weight: approx. 16 kg
Height/length max.: approx. 5 m
Height as ladder stand: approx. 2,4 m
Height as scaffolding: approx. 1,4 m
Steps: 4/4/4/4

With footstep to hinge
With 2 x traverse to improve stand and safety



3054 Reflotron Applicator

Pipetting aid for holding and draining disposable capillary pipettes (ringcaps® for Reflotron®), with ejection mechanism and replaceable adapter.



3055 BRUSH, SCRUB, long and adjustable handle, nylon bristles

For cleaning rubber boots

Material:

- Body: polypropylene (should not be in wood)
- Bristles: nylon

Handle length: adjustable between 50 and 100 cm

Brush width: approx. 13,5 x 5 cm

Soft bristles

Non-sterile



3056 BRUSH, SCRUB, for boots, nylon bristles

For cleaning rubber boots

Mounted on metal frame

Material:

- Body: polypropylene (should not be in wood)
- Bristles: nylon

Soft bristles



3057 THERMOMETER FOR ROOM TEMPERATURE

Room Temperature Wall Thermometer

It Can be used in or outdoors.

Easy-to-read Celsius and Fahrenheit temperature readings

Durable and accurate

*Color: White. *Material: Plastic. *Size: (L) 20cm x 4.5cm.



REF. DESCRIPTOR
Specification

3058 FIRST AID BANDAGE CLOTH DIN 13152 - A

60x80cm
for all large wounds
Individually sterile packed



3059 Cotton Wool Roll 500g

100% cotton
No fleecing
Easy to unroll and separate
Size: 500g/roll
Individually pack with blue draft paper or in plastic bag



Available in 500g.

3060 TUBE, WENDL, NASOPHARYNGEAL airway, No 26

Nasopharyngeal airway, Wendl pattern,
With adjustable flange
Size: CH 26
Material: Latex-free
Packaging: sterile, individual packing for single use

3061 TUBE, WENDL, NASOPHARYNGEAL airway, No 28

Nasopharyngeal airway, Wendl pattern,
With adjustable flange
Size: CH 28
Material: Latex-free
Packaging: sterile, individual packing for single use

3062 DRAIN, THORACIC, CH 24, straight, 50 cm, sterile, disposable

Material: transparent medical Polyvinyl chloride (PVC)
Kink-resistant smooth
Length: 50 cm
Radio-opac broken line (Sentinel line): broken at the first proximal eye (Sentinel eye)
Numerical graduations: every 2 cm
Eyes: 6 lateral, atraumatic (holes)
Distal end/tip: atraumatic. round end, open
Proximal end/tip: bevelled for atraumatic tissue crossing
Diameter: 8,0 mm
Packaging: 1 catheter, sterile, disposable
Must be supplied with double packaging: one interior layer plus sterilised peel pack
Labeling should mention: name and/or trademark of the manufacturer, sterile, lot number, expiry date by year and month, "for single use". CE + number; product description
Other requirements: Manufacturer has to be ISO certificated: ISO: 9001/EN46001 or ISO 9002/EN 46002, class IIa

3063 BLOOD SAMPLING, Multi-Sample Needles, 20G 0,9 x 38mm

Material: Plastic
Safe blood collection system; single use
Packaging and labeling: each needle in sterile peel pack, should mention exp date, lot number, items description, size, type of sterilization, manufacturer name, ref number, CE + Nr, protective carton packing with same information and no. of units



3064 OXYGEN AEROSOL MASK, for adults, Venturi-set, disposable

Oxygen breathing mask for adults
With squeeze-free connection hose
Incl. 6 valves for concentrations
For 24%, 28%, 31%, 35%, 40% and 50%
Aerosol mask with connecting hose
Length: 2,1m / 7 feet
Latex free
With rubber band and nose clip
Color: transparent / clear
Non-sterile packaging



3065 SWAB, Flexible Minitip (Nasopharyngeal) Flocked, with 100mm Breakpoint

with 3 mL UTM liquid transport medium in 100mm tube
Individually Packaged
Sterile



3066 SWAB, Regular Flocked (Oropharyngeal), with 100mm Breakpoint

with 3 mL UTM liquid transport medium in 100mm tube
Individually Packaged
Sterile



4000 PEN, FELT TIP, fine, SET, permanent, overhead projector, 4 colours

4001 BUCKET, plastic, without lid, 5L

Specifications: Heavy-duty plastic, round bucket
Carrying capacity 5 kg
With metal handle
Stacking possibilities to lower transport costs
Strong and durable quality for a long life span in tough conditions.

Material: Plastic

4002 COOKING POT, 2L, with handles and lid

Cooking pot, 2l
Cooking pot with handles and lid
Capacity: 2-3 L
Material: anodised Aluminium or stainless steel

4003 HOTPLATE, single, 230V

Electrical single hot plate
Specifications: Electric Single Hot Plate with Automatic Safety Shut-off and Adjustable Temperature Control and CE approved
Power 1300 - 1500 W
Voltage 230V



4004 LIGHTER

4005 Kitchen paper tissue



4006 KIT, WATER LAB TEST, bacteriologic, + accessories, Delagua

The DelAgua kit is designed to carry out five basic tests to measure the quality of drinking water : Ecoli, turbidity, free chlorine, total chlorine and ph. The kit is designed for the use in the field.

Specifications

- Dimensions: 370 x 140 x 260mm
 - Weight: Approx 10kg
 - Incubator: Temperature 44°C, power 12v (internal battery-charger supplied), capacity 16 x 47mm petri dish
- * The kit is supplied with consumables for 200 tests.

Equipment List

- DelAgua single incubator (44°C) test kit with consumables for 200 tests.
- Conductivity meters
- Steriliser kits
- Turbidity tubes
- Comparitor (chlorine and PH) - pool tester type
- Chlorine testing and PH testing meters

Consumables

- DPD No. 1 tablets - for residue chlorine testing
 - DPD No. 3 tablets - for total chlorine testing
 - Phenol red tablets - for PH testing
- *Membrane Filters & Pads (x200)
*Culture Medium (38.1g tub)

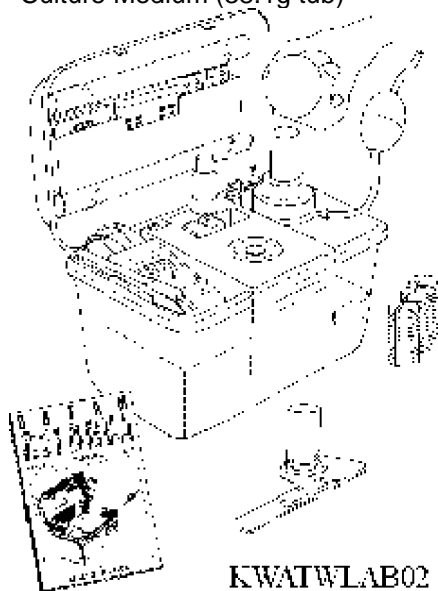

4007 SYRINGE, 2 ml, 2 parts, disposable

Material: Clear polypropylene (medical grade) or polyethylene, transparent enough for easy reading and air bubbles detection

Specifications: Barrel, cylindrical with easy-to-read, clear and water resistant graduations scale, ended by a conical male Luer Connection

Plunger: must give a proofed seal

Unit presentation: one syringe, single use, sterile, individual peel packs made of paper

and/or plastic

Labelling: Exp date, lot number, items description, needle size, multilingual, type of sterilization, manufacturer name, ref number, CE + Nr

Packaging: Protective packaging: carton, same labelling as unit presentation + total quantity.

Other Requirements: Must order needle

Conforms to EN-ISO7886-1 and EN-ISO20594-1 standards



4008 SYRINGE, 5 ml, 2 parts, disposable

Material: Clear polypropylene (medical grade) or polyethylene, transparent enough for easy reading and air bubbles detection

Specifications: Barrel, cylindrical with easy-to-read, clear and water resistant graduations scale, ended by a conical male Luer Connection

Plunger: must give a proofed seal

Unit presentation: one syringe, single use, sterile, individual peel packs made of paper and/or plastic

Labelling: Exp date, lot number, items description, needle size, multilingual, type of sterilization, manufacturer name, ref number, CE + Nr

Packaging: Protective packaging: carton, same labelling as unit presentation + total quantity.

Other Requirements: Must order needle

Conforms to EN-ISO7886-1 and EN-ISO20594-1 standards

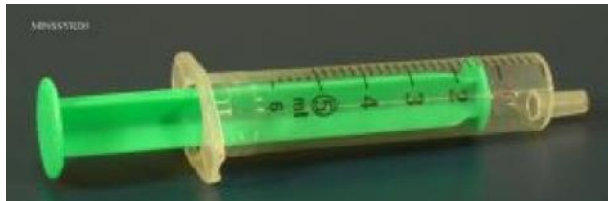

4009 SYRINGE, 10 ml, 2 parts, disposable

Material: Clear polypropylene (medical grade) or polyethylene, transparent enough for easy reading and air bubbles detection

Specifications: Barrel, cylindrical with easy-to-read, clear and water resistant graduations scale, ended by a conical male Luer Connection

Plunger: must give a proofed seal

Unit presentation: one syringe, single use, sterile, individual peel packs made of paper and/or plastic

Labelling: Exp date, lot number, items description, needle size, multilingual, type of sterilization, manufacturer name, ref number, CE + Nr

Packaging: Protective packaging: carton, same labelling as unit presentation + total quantity.

Other Requirements: Must order needle

Conforms to EN-ISO7886-1 and EN-ISO20594-1 standard



4010 SYRINGE, 20 ml, 2 parts, disposable

Material: Clear polypropylene (medical grade) or polyethylene, transparent enough for easy reading and air bubbles detection
Specifications: Barrel, cylindrical with easy-to-read, clear and water resistant graduations scale, ended by a conical male Luer Connection
Plunger: must give a proofed seal
Unit presentation: one syringe, single use, sterile, individual peel packs made of paper and/or plastic
Labelling: Exp date, lot number, items description, needle size, multilingual, type of sterilization, manufacturer name, ref number, CE + Nr
Packaging: Protective packaging: carton, same labelling as unit presentation + total quantity.
Other Requirements: Must order needle
Conforms to EN-ISO7886-1 and EN-ISO20594-1 standard

4011 ALUMINIUM Test, Lovibond Testpack

Colorimetric test for Aluminium based on the Lovibond Checkit System The TESTPACK contains:
1 X CHECKIT@Disc,
30 x tablet reagents
2 x cells,
1 x stirring rod
1 x detailed instructions

Range : 0 - 0,3 mg/l
Brand : Lovibond Aluminium TESTPACK
Order No. : 14 77 00



4012 BUFFER, pH 4,0, 1 tab/100ml

Buffer tablets to prepare buffered calibration solution

4013 BUFFER, pH 7,0, 1 tab/100ml

Buffer tablets to prepare buffered calibration solution

4014 CHLORINE and PH Test, Lovibond Test Kit 2 in 1 with Checkit Comperator 0,1 - 2 mg/l

Kit to test chlorine and ph

a) Test Kits 2 in 1

Specification: Together with the CHECKIT®Comperator, each test kit includes CHECKIT®Discs, cells, stirring rod and Lovibond® tablet reagents (30 tests) for the desired test.

The test kits are supplied in a sturdy and handy plastic case.

Range:	Chlorine 0.1 - 2.0 mg/l Cl ₂ * pH value 6.5 - 8.4 pH
Method:	Colorimetric with colour-disc comperator
Brand :	LOVIBOND
Order No:	14 70 46

b) additional tablet reagents:

DPD1 rapid	: 100 pcs
packing	: aluminium foil blister



4015 CHLORINE Test, Merck Microquant, 0,25 - 15mg/l

Chlorine test, Merck MicroQuant

Range : 0,25 - 15mg/L
Method : Colorimetric with colour-disk comparator
Brand/Type : Merck, MicroQuant
ArtNo. :1.14826.001

4016 DPD1 rapid, tablets

Reagent for the determination of chlorine

4017 DPD3 rapid, tablets

Reagents for the determination of chlorine

4018 HARDNESS, TOTAL, test strips 3-21°dH

Test strips for the determination of total hardness

Range : 3-4-7-14-21 °dH

4019 pH-TEMP-COND-Meter, HANNA HI 98130 incl spare electrodes

digital measure instrument for the determination of pH, temperature , conductivity, total dissolved solids Specification:

Combination waterproof pH / EC / TDS / °C Tester with replaceable pH electrode

Casing: Rugged, Floating Waterproof

Range :

EC (Electrical Conductivity) 0 to 20.00 mS/cm

TDS (Total Dissolved Solids) 0 to 10.00 ppt

pH 0.00 to 14.00 pH

Temperature 0.0 to 60.0 °C

identical in construction with HANNA HI 98130
Scope of Delivery:
1 x Combi Tester
2 x Replacement electrodes

4020 POOL TESTER + accessories

Testkit for the determination of chlorine and pH
simple testkit which works with DPD and phenol red tablets

Range : Chlorine 0,1 - 3,0 mg/l,
pH-value 6,8 - 8.2
Methode: Colorimetric with DPD and phenol red tablets
Brand/Order No.: Lovibond POOLTESTER Chlorine-pH, ArtNo.: 151050



4021 CULTURE MEDIA FOR FEACAL COLI, 2ml, box of 50 amp

Culture media for E-Coli
Ready to use culture media for E-coli packed in ampule, shelf life has to as long as possible.
e.g. Milipore m-FC broth with rosolic acied

Incubation temperature : 44°C
Package : 2ml ampule

4022 BEAKER, POLYPROPYLENE OR PMP, 1000 ml

Graduated container to measure liquids
Material: Polypropylene or PMP (TPX)
Specification: Beaker low form
Capacity 1000 ml, graduated
Packaging: Individually packed

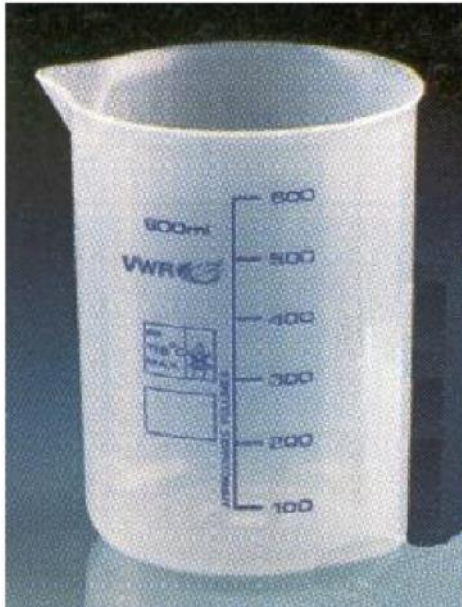

4023 BEAKER, POLYPROPYLENE OR PMP, 100ml

Graduated container to measure liquids
Material: Polypropylene or PMP (TPX)
Specification: Beaker low form
Capacity 100 ml, graduated
Packaging: Individually packed

4024 BOTTLE, swan neck jet, plastic, 500 ml

Round bottle with swan neck jet used for staining and rinsing
Material: Polyethylene
Specifications: Bottle round; not graduated
Swan neck jet
Capacity 500 ml
Dropper nozzle with screw cap

4025 SCALE, NUTRITION, 5 kg, grad. 2/5g, electro., platform



4026 SCALE, NUTRITION, 2 kg, grad. 1g, electro., platform



4027 SCALE, NUTRITION, 200 g, grad. 0,1g, electro., platform



5000 BAG, PE plastic, for garbage, 60L, black, 0.02mm

Specifications: At least 0.02mm thick plastic
As used for domestic garbage
Material: PE

5001 BOOTS, rubber (Wellington), size 37, pair

according to EN 345 S5
Sole: material PVC/Nitril, antistatic oil-, acid-, petrol-resistant steel layer in sole
Weight: approx 2 kg/pair
Shaft: material PVC/Nitril
Height: approx 38 cm



5002 BOOTS, rubber (Wellington), size 39, pair

according to EN 345 S5
Sole: material PVC/Nitril, antistatic oil-, acid-, petrol-resistant steel layer in sole
Weight: approx 2 kg/pair
Shaft: material PVC/Nitril
Height: approx 38 cm

5003 BOOTS, rubber (Wellington), size 41, pair

according to EN 345 S5
Sole: material PVC/Nitril, antistatic oil-, acid-, petrol-resistant steel layer in sole
Weight: approx 2 kg/pair
Shaft: material PVC/Nitril
Height: approx 38 cm

5004 BOOTS, rubber (Wellington), size 44, pair

according to EN 345 S5
Sole: material PVC/Nitril, antistatic oil-, acid-, petrol-resistant steel layer in sole
Weight: approx 2 kg/pair
Shaft: material PVC/Nitril
Height: approx 38 cm

5005 BOOTS, heavy duty plastic rubber, pair, size 10

5006 BOOTS, heavy duty plastic rubber, pair, size 9

5007 GLOVE, chemical protection, nitrile, heavy duty rubber, size 10

5008 GLOVE, chemical protection, nitrile, heavy duty rubber, size 7

5009 GLOVE, H. DUTY, leather + canvas, pair, size M

Heavy Duty Work Gloves
Material Palm: leather
Back: denim



5010 GLOVE, heat protection, isothermal, pair, size 10

5011 OVERALL, blue cotton, size L



5012 OVERALL, blue cotton, size M

5013 OVERALL, blue cotton, size S

5014 OVERALL, blue cotton, size XL

5015 FIRE EXTINGUISHER, Bucket pump

refillable fire extinguisher for fire classification A
Bucket pump according DIN 14 405
Bucket made by metall, with 5 m firebrigade hose Storz D



5016 TAPE, Area delimitation, white/red, 50mmx500m, dispens. Box

5017 CHLORINE, Aquatab, 1000mg (NaDCC 1670mg), multipurpose, 200 tab..

NaDCC (sodium dichloroisocyanurate, or sodium troclosene, or sodium dichloro-s-triazinetrione)

1.67g NaDCC releases 1g available chlorine when it is dissolved in water. Each Tablet contains 1670 mg of NaDCC

Packing size : 200 tablets

5018 CHLORINE, Aquatabs, 5000mg (NaDCC 8680mg), fr 1000L wat. purif., tab.

NaDCC (sodium dichloroisocyanurate, or sodium troclosene, or sodium dichloro-s-triazinetrione)

1.67g NaDCC releases 1g available chlorine when it is dissolved in water. Each Tablet contains 1670 mg of NaDCC

Packing size : 200 tablets

5019 CABLE, elect. flexible, 5 x 2.5mm², outdoor use, black, met.

Heavy Duty cable 5 x 2,5mm

Specification : H07RNF 5G2,5

5020 CABLE, elect. Flexible, 5x10mm², outdoor use, black

Heavy Duty cable 5 x 10mm

Specification : H07RNF 5G10

5021 Core cable ends 1,5mm

5022 Core cable ends 2,5mm

5023 Distribution board, worksite

Structurally identical to Steidle EV 63/82-0-S

Final distributor in orange metal housing (IP44)

Nominal value: 63A

Apparent power: 44kVA

Voltage: ~230/400 V

Frequency: 50/60 Hz

RDF: 0,6

Protection: RCCB 0,3A

Protection (housing): IP44

Weight: approx. 42kg

Dimensions (metal housing): approx. 610 x 730 x 400 mm (W x H x D)

With removable metal stand (approx. 360 mm high)

With 5 m power supply line H07RN-F 5G16



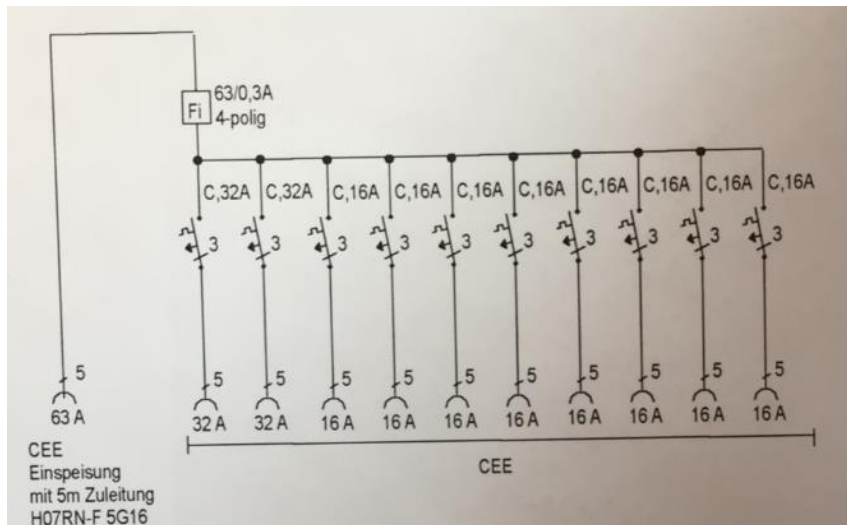

5024 Distribution box 400V to 6 x 230 V

Safety Distribution 400V to 6 x 230 V,
structurally identical with GIFAS Industrial distribution boxes, series 6200 Art.Nr.: 235519 or
ABL SURSUM Art. Z55.16 or Menekes EverGum

Input : 3m cable 5x2,5mm with CEE 16A/400V, IP44
Output : 6 x CEE 7/3 (Type F, safety contact sockets) IP44
Protection : FI 25/0,03 A 4p; LS 16 A 3p
Temperatur range : 40° to -20°C
Casing : self-extinguishing and flameretardant solide rubber



5025 Distribution box, 1 x 400V to 1x 400V and 3x 230V

Safety Distribution 400V to 1 x 400V and 3 x 230 V,
structurally identical with GI FAS Industrial distribution boxes, series 6200 or Menekes
EverGum or ABL SURSUM series Z48.01 or Z55.01

Input : 3m cable 5x2,5mm with CEE 16A/400V, IP44
Output : 1 x CEE 16A/400V , IP44
: 3 x CEE 7/4 (Type F, safety contact sockets), IP44
Protection : FI 25/0,03 A 4p ; LS 16A for all outputs
Temperatur range : 40 to -20°C
Casing : self-extinguishing and barely flammable solide rubber



5026 Distribution box, 1x400V/32A to 2x400V/16A and 3x230V

Safety Distribution 400V to 1 x 400V and 3 x 230 V,
structurally identical with GI FAS Industrial distribution boxes, series 6200, Mennekes
EverGum or ABL SURSUM series Z48.01 or Z55.01

Input : 3m cable 5x6,0mm² with CEE 32A/400V, IP44
Output : 2 x CEE 16A/400V , IP44
: 3 x CEE 7/4 (Type F, safety contact sockets), IP44
Protection : FI 25/0,03 A 4p and LS 16A 3p
Temperatur range : 40 to -20°C
Casing : self-extinguishing and barely flammable solide rubber



5027 Distribution box, 1x400V/32A to 1x400V/32A, 2x400V/16A and 3x230V

Safety Distribution 400V to 3 x 400V and 3 x 230 V,
structurally identical with GI FAS Industrial distribution boxes, series 6200, Mennekes
EverGum or ABL SURSUM series Z48.01 or Z55.01

Input : 1 x CEE 32A/400V, IP44
Output : 1 x CEE 32A/400V , IP44
: 2 x CEE 16A/400V , IP44
: 3 x CEE 7/4 (Type F, safety contact sockets), IP44
Protection : FI 25/0,03 A 4p (only for 16A/400V and 16A/230V; not for
32A/400V) and LS 16A 3p
Temperature range : 40 to -20°C
Casing : self-extinguishing and barely flammable solid rubber



5028 EXTENSION CABLE, 10m, 3x2,5mm² triple connector

Heavy Duty extention cable 3 x 2,5m m, 10m
Specification : H07RNF 3G2,5
Length : 10m
Plug: : solid rubber, CEE 7/4 (Type F, Schuko), IP44
Connector : triple connector solid rubber, CEE 7/4 (Type F, Schuko), IP44



5029 EXTENSION CABLE, 10m, 5 x 2,5mm², 16 A

Heavy Duty extention cable 5 x 2,5m m², 10 m, CEE coupling
Specification : H07RNF 5G2,5
Length : 10m
Plug: : CEE 5x16A / 400V, IP44
Connector : CEE 5x1 6A / 400V, IP44

5030 EXTENSION CABLE, 25m, 3x2,5mm², triple connector

Heavy Duty extention cable 3 x 2,5mm, 25m
Specification : H07RNF 3G2,5
Length : 25m
Plug: : solid rubber, CEE 7/4 (Type F, Schuko), IP44
Connector: triple connector solid rubber, CEE 7/4 (Type F, Schuko), IP44



5031 EXTENSION CABLE, 25m, 5x2,5mm², 16A

Heavy Duty extension cable 5 x 2,5mm², 25 m, CEE coupling
Specification : H07RNF 5G2,5
Length : 25m
Plug: : CEE 5x16A / 400V, IP44
Connector : CEE 5x16A / 400V, IP44

5032 EXTENSION CABLE, 25m, 5x6, 0m², 32A

Heavy Duty extension cable 5 x 2,5mm², 25 m, CEE coupling
Specification : H07RNF 5G6,0
Length : 25m
Plug: : CEE 5x16A / 400V, IP44
Connector : CEE 5x16A / 400V, IP44

5033 EXTENSION CABLE, 3m, 5 sockets, IP44, with surge protection

Extension Cable with switch, surge protection and 5 sockets Protection: IP44



5034 EXTENSION CABLE, 5m, 3x2,5mm², triple connector

Heavy Duty extension cable 3 x 2,5mm², 5m
Specification : H07RNF 3G2,5
Length : 5m
Plug: : solid rubber, CEE 7/4 (Type F, Schuko), IP44
Connector : triple connector solid rubber, CEE 7/3 (Type F, Schuko), IP44



5035 LAMP, LED, 230V, with E27 bulb, warm white, 806 lm, hand-held, with basket

Hand-held light with basket guard and 5m cable. Impact proof and resistant to chemical influences. Hand grip made of rubber. With E27 bulb, warm white, 806 lm



5036 PLUG, female, CEE 400V/16A 5p

female PLUG according CEE, 16A 400V 3p+N+E
specification: IEC 60309
with cord grip and cable bend protection certified by VDE and CE
protection classification : IP44



5037 PLUG, female, CEE 400V/32A 5p

female PLUG according CEE, 32A 400V 3p+N+E
specification: IEC 60309
with cord grip and cable bend protection certified by VDE and CE
protection classification : IP44



5037a PLUG, male, CEE 400V/32A 5p

female PLUG according CEE, 32A 400V 3p+N+E
specification: IEC 60309
with cord grip and cable bend protection certified by VDE and CE
protection classification : IP44



5038 PLUG, female, CEE 400V/63A, 5p

female PLUG according CEE, 63A 400V 3p+N+E
specification: IEC 60309
with cord grip and cable bend protection certified by VDE and CE
protection classification : IP44



5039 PLUG, male, CEE 400V/16A, 5p

male PLUG according CEE, 16A 400V 3p+N+E
specification: IEC 60309
with cord grip and cable bend protection certified by VDE and CE
protection classification : IP44



5040 PLUG, male, CEE 400V/63A, 5p

male PLUG according CEE, 63A 400V 3p+N+E
specification: IEC 60309
with cord grip and cable bend protection certified by VDE and CE
protection classification : IP44



5041 SOCKET, wall mount, single 16A Schuko

Wall Socket 230V, 16A CEE-7/7
(Schuko) Protection : IP44, splashproof

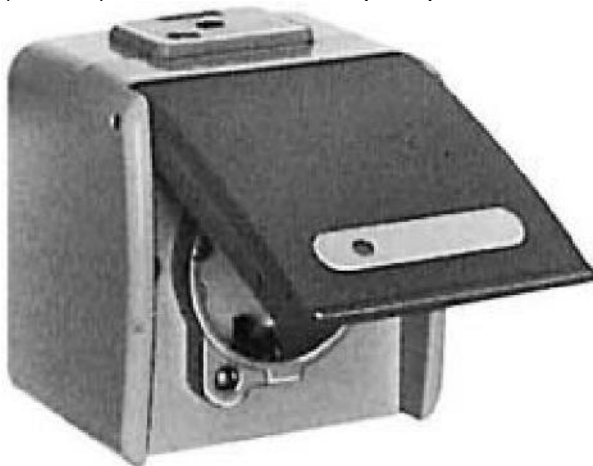

5042 TRIPOD, telescopic, with lightning ballon, 230V, 600W LED, 60.000 lm

Telescopic tripod set for lightning ballon, heavy duty construction

Specification:

1 x tripod

Structurally identical with Eisemann Tripod LZU 15, Metallwarenfabrik Gemmingen

1 x lightning ballon, AIRSTAR SIROCCO 6x100W

3 x sandbag (12kg)

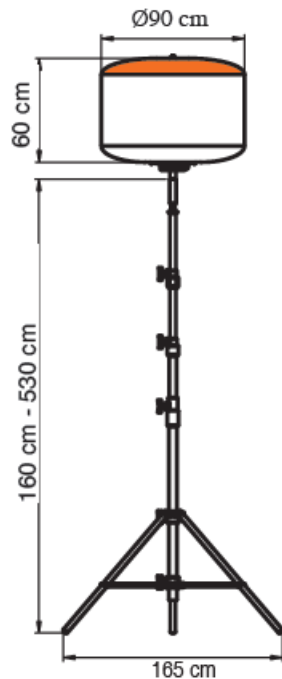

5043 TRIPOD, telescopic, with spotlights

Telescopic tripod set for spotlights or floodlight sources, heavy duty construction
Specification:

a) 1 x tripod

4 spotlight attachment points fixable at the desired height. The tripod has 3 mounting points for bracing wire.

30mm diameter attachment pin according DIN 14640

Structurally identical with Eisemann Tripod LZU 15, Metallwarenfabrik Gemmingen

b) 1 x spotlight holder for 30mm attachment pin

480mm x 50mm x 145mm with 30mm attachment pins according DIN 14640 Structurally identical with Eisemann Spotlights holder LZU 11/7,

c) 2 x universal holder for 30mm attachment pin

Universal holder for 30mm attachment pins according DIN 14640 with M10 mounting screw

Structurally identical with Eisemann Universal holder LZU 11+M10

d) 2 x Halogen floodlight projector with 5m cable and 2 Halogen lamp tubes El. specification:

Max. Power : 500W

Operating Voltage : 230 V

with cable and CEE 7/4 (Schuko, Type F) plug

Protection degree: IP 55

Mechanical Specification:

die-casting aluminium body, all external steel parts are rust-free brightened aluminium reflector, angle range 100°

tempered glass resistant to wide changes in temperature

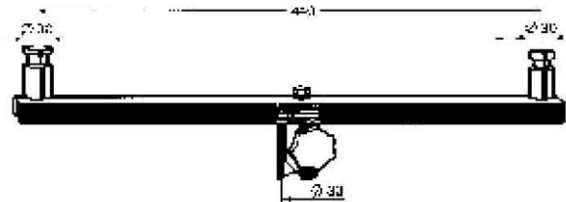

5044 Fence, plastic

Plastic safety mesh fencing to cord off danger areas, construction sites etc

Specification:

With :	90 - 100 cm
Color :	red, orange or yellow
Weight :	not less than 140 g/m ²
Length :	50m per roll
Material :	PP or PE

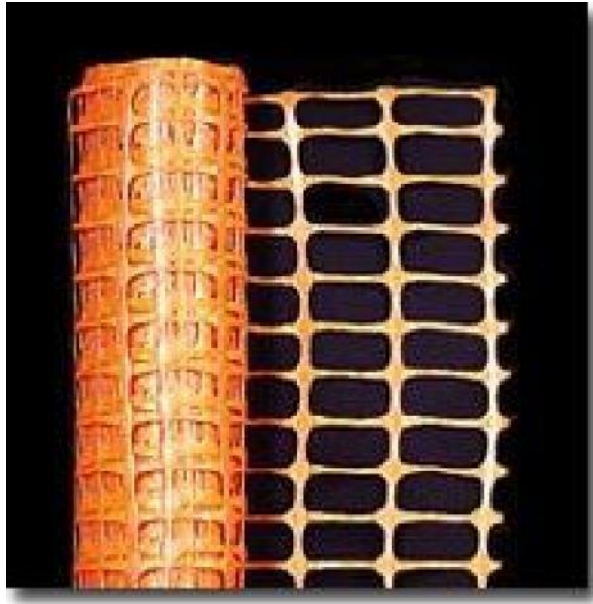

5045 Plastic Stake Fencing Pins, orange

Colour: Orange

Plastic post complete with metal spike

U.V resistant polypropylene

Handy footplate for easy installation

Integral clips & loops to fix

Ideal for supporting barrier fencing, tapes, mesh or rope.

Size : 1m above ground (ie not including the spike)

Pin is 220mm

The 1m Stake is 980mm from the top of the footplate to the top of the post. Ideal for Barrier Fencing

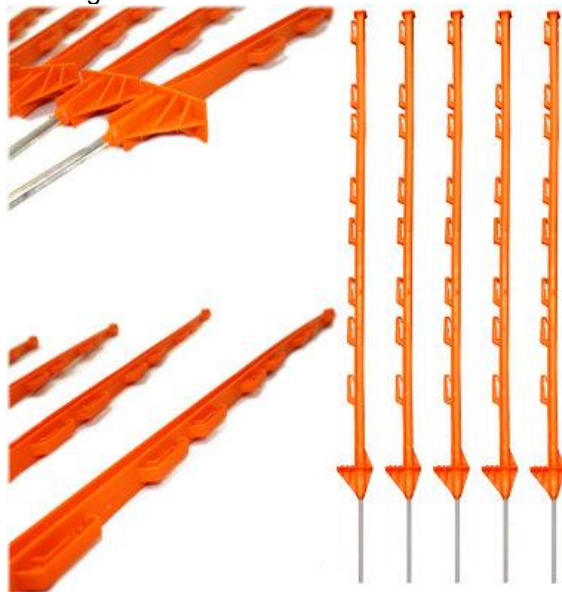

5046 GOGGLES, SAFETY, plastic

Safety goggles according EN 166
deep curved PVC frame, close fit and versatility to wear over prescription glasses.
Clear polycarbonate lenses.
Protection against impact from flying particles, droplets, splashes. Vented body (indirect ventilation). Chemicals resistant



5047 clamp meter 0-400A

Clamp Meter	0-400A
Currency AC: Range	0-400 A
Resolution	0,1A
Voltage AC : Range	0-600 V
Resolution	1 V

Safety Specifications: IEC 1010-2-032, 600V CAT III
VDE, GS or comparable certificates



5048 LEVEL, aluminium, 400 mm, standard, vertic. horizont. vials



5049 LINE LEVEL, to use with builder's line



5050 KNIFE/CUTTER, retract. chang. snap-off blade, 165mm, plastic



5051 SCREWDRIVER, flat head 6.5mm x 200mm blade

Material: Chrome Vanadium Steel, hardened, tempered and chrome plated

5052 SPANNER SOCKET, Bi Hexagon 17mm -3/8" Square drive

Specifications: 17mm Bi Hexagon Socket for 3/8" Square drive.
Chamfered end for positive nut.
Hole for driving accessory spring-loaded ball bearing

Quality: Professional

Material: Chrome Vanadium Steel. Hardened, tempered and chrome plated



5053 SPANNER, combinaison, open + 15deg angled ring, 17mm

Specifications: Combination ring/open-end spanner 24mm

Quality: Professional

Material : Chrome Vanadium Steel, hardened, tempered and chrome plated

5054 SPANNER, combinaison, open + 15deg angled ring, 24mm

Specifications: Combination ring/open-end spanner 24mm

Quality: Professional

Material : Chrome Vanadium Steel, hardened, tempered and chrome plated

5055 SPEED BRACE, 3/8" square drive cranked handle

Specifications: Speed Brace, 3/8" square drive cranked handle
plastic hand grip, spring-loaded ball bearing for secure socket holding
Quality: Professional
Material : Chrome Vanadium Steel, hardened, tempered and chrome plated



5056 BUCKET, plastic, without lid, 10 L

Specifications: Heavy-duty plastic, round bucket
Carrying capacity 20 kg
With metal handle
Stacking possibilities to lower transport costs
Strong and durable quality for a long life span in tough conditions.
Material: Plastic



5057 CHAIR, FOLDABLE, ARMCHAIR, nylon seat and back

type: director's chair
lightweight
frame



5058 BOX, FOLDING, 60L

Folding box to be used as a clothes basket
Size : 60 L
Material : plastic material

5059 BUCKET, plastic, without lid, 25 L

5060 CLOTHES LINE, 50m

Clothes line with steel inlay and plastic coat.
Diameter : appr. 3mm
Length : 50m

5061 CLOTHES PIN



5062 DRAINAGE PIPE, 22mm for washing mashine

Universal drainage pipe for washing mashines

Construction : flexible spiral tube made of plastic material

Diameter : 22 mm

Lenght : 5 m



5063 STEAM IRON

Functions: Dry and steam

Voltage: 230 V/50 Hz

Power: appr. 1800 W

Soleplate: stainless with non-stick coating

5064 TUMBLE DRYER, vented

Vented tumble dryer

Capacity : 6 kg

Voltage : 230V/50Hz

Spin drying class : C
Energy efficiency class : D

5065 VENT HOSE, d=100mm, 5m

Flexible standart vent hose for tumble dryer
diameter : 100 mm
lenght : 6 m



5066 WASHING MASHINE, 8 kg

Front loader household washing machine
Capacity : 8 - 9 kg
Voltage : 230 V/50Hz
Washing performance class*) : A
Spin performance class *) : B
Energy efficiency class : B

*) according EN 60456

5067 WASHING POWDER, 20kg, for washing machine, for cloth

5068 TARPAULIN, woven plastic, 4 x 6 m, white/white, piece

Reinforced flexible tarpaulins for temporary shelter or personal protection
Specifications

Material: Woven high-density polyethylene (HDPE) black fibers fabric laminated on both sides with low density polyethylene (LDPE) coating. Reinforced with 6 bands of 7.5cm width made of woven black HDPE fibers fabric and coated outside. Position of bands as per drawing attached.

Tensile strength : Minimum 50DaN and 15% to 25% elongation in warp and weft outside of the reinforcement bands under ISO 1421. Minimum 70DaN inside the reinforcement Bands as per ISO 1421 plus the additional procedure.

Tear strength: Minimum 1 0DaN under ISO 4674 (A2) outside of the reinforcement bands.

Welding: Only one welding allowed, in the middle of the sheet, length wise.
Minimum resistance is 80% of the original tarpaulin tensile strength in weft under ISO 1421 plus additional procedure.

UV resistance: Maximum 5% loss on original tarpaulin tensile strength under ISO 1421

after 1500 hours UV under ASTM G53/94 (UVB 313 nm peak), to be tested outside and inside the reinforcement bands.

Width 4 m standard size $\pm 1\%$ net width
 Length Sheet of 6 meter, or rolls of 60 meters
 Weight 200g/m² $\pm 5\%$, plus 10% for the reinforcement bands under ISO 3801.
 Temperature resistance Temperature resistant from -20 to 80 C.
 Features Water, rot, soil and fauna resistant. Long outdoor use life in all climates.
 Flammability Flash point above 200C.
 Colour White sun reflective both sides, grey bands. Inner black fibers to ensure opacity.
 Printing For rolls every 6m, for pieces on each piece, Manufacturer name, month and year of production (Letters of 2.5cm [1 inch] high maximum). One length Indicator
 Indicator

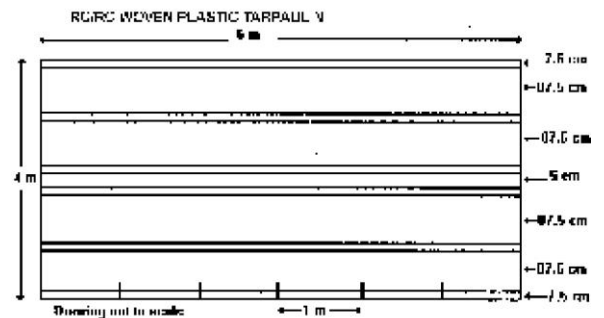



5069 PLASTIC SHEET for windows, not antiblast film, 0.2mm, 2 x 50 m roll

General information:

Translucent plastic sheets to replace window glass.

Reinforced type is stronger and lasts longer.

Woven plastic sheets are not usable for this application, as they are not sufficiently translucent.

This product is totally different from anti-blast film for window glasses, it is only meant to replace window glasses.

Specifications:

Plastic sheeting, reinforced with polyester or PP/PE mesh, 0.200mm, UV stabilised, 2m x 50m,roll.

5070 BUCKET, plastic, 20L, white, metal handle, with lid, stackable

Specifications:

Heavy-duty plastic bucket, with handle and lid with attached clip -on cap.

Manufacturing process: injection moulding.

Material: Virgin food grade HDPE high density polyethylene, and virgin LDPE low density polyethylene OR: Virgin food grade Polypropylene Copolymer (PPCP).

Should not contain toxic elements according to EN 1186-3-9 standard.

Reinforced bottom ridge to prevent scraping of the base.

Reinforced top to prevent ovaling.

Curved inside base to wall join for easy cleaning.

Colour: Bucket and lid: white.

Marking: Manufacturer identification plus manufacturing month and year molded on the bucket.

Lid test: The bucket filled with 20L water must resist one fall on the side without opening.

Drop test: The bucket filled with 20L water, must resist without damage to 2 consecutive vertical drops from 2m high from bucket bottom to smooth flat concrete floor. The bucket must be elevated on a remote-activated rocking platform, so that the lowest point is at 2m from the ground.

Flexibility test: The bucket must get back its original shape without damage after applying a pressure on the two sides of top rim to make them touch one another in the middle.

Handle test: The handle must resist folding flat on the cover, pushed on left end, and pushed on right end. The handle must also resist to 28kg traction in normal usage position



5071 LADLE, 250ml, stainless steel

Capacity about 250ml. Handle length about 32cm. Commercial quality.
Can be conveniently nested on pot rim, or hung on rack!
Safe to use in dishwasher



5072 KIT, WATER TANK, 10 m3, rigid, corrugated

Specification: Ridged water tank, fast erection, light and small volume for transport
Corrugated galvanized iron sheet
Each tank has 3 outlet holes for 3" connector. One of these holes has a blanking plate fitted.
EPDM synthetic rubber line, 1,4mm thick, reinforced, welded. The liner allows
300mm turndown on outside with 4 eyelets spaced at 1m centers around edge
Connector flanges to be pre-assembled with studs, bolts, washers and gaskets. PVC coated
polyester roof
Base plate for roof supporting column has countersunk holes to prevent damaging the lining
by friction with the bolt heads
Bolts and nuts are all zinc plated for high corrosion resistance.
Spanners of good quality for intensive use.
including roof repair kit

Capacity: 10m3



5073 KIT, WATER TAP STAND, 6 self-closing taps

One wooden box contains all the necessary items to assemble a complete stand, and to terminate with a Storz C + 1.1/4" BSP + 32mm compression coupling.

Self-closing valves (Talflo, etc...) close "automatically", saving water.

Material: Galvanized steel water pipes of 1.1/4" in diameter, with couplings and clamps

Supplied with set-up tools and accessories (e.g. PTFE tape)

Packaging: 1 wooden box, with 2 handles



5074 CHLORINE and PH Test, Lovibond Test Kit 2 in 1 with Checkit Comperator 0,1 - 2 mg/l

a) Test Kits 2 in 1

Specification: Together with the CHECKIT®Comperator, each test kit includes CHECKIT®Discs, cells, stirring rod and Lovibond® tablet reagents (30 tests) for the desired test.

The test kits are supplied in a sturdy and handy plastic case.

Range: Chlorine 0.1 - 2.0 mg/l Cl₂*
pH value 6.5 - 8.4 pH

Method: Colorimetric with colour-disc comperator

Brand : LOVIBOND

Order No: 14 70 46

b) additional tablet reagents:

DPD1 rapid : 100 pcs

packing : aluminium foil blister



5075 JERRYCAN, 20 l, metallic, with nozzle, for diesel

Jerry can manufactured from steel with fuel resisting lining. With TÜV approval
Capacity: 20L



5076 CHLORINE, (NaDCC) granulate, 25 kg

NaDCC (sodium dichloroisocyanurate, or sodium troclosene, or sodium dichloro-s-triazinetrione)

1.67g NaDCC releases 1g available chlorine when it is dissolved in water. Packing size : 25 kg granulate per bucket

5077 CLAMP, BAND 20-32mm

Worm drive hose clamp suitable for rubber hose, plastic tubing Width : 5mm

Position range : 20-32mm

Material: chrome steel



5078 HOSE CLAMP, 16-27mm

Worm drive hose clamp suitable for rubber hose,
Position range : 16-27mm
Material: chrome steel



5079 HOSE CLAMP, 12-22mm

Worm drive hose clamp suitable for rubber hose,
Position range : 12-22mm
Material: chrome steel

5080 HOSE CLAMP, 25-40mm

Worm drive hose clamp suitable for rubber hose,
Position range : 25-40mm
Material: chrome steel

5081 CLAMP, BAND 55mm

to clamp a hose on an Storz C hose tail coupling
Specification: Heavy duty T- Bolt Clamp for robust application for use with a Allen Key



5082 CLAMP, BAND 85mm

to clamp a Y" hose with a Storz B hose tail coupling
Specification: Heavy duty T- Bolt Clamp for robust application for use with Allen Key



5083 HOSE FITTING, 50mm inner diameter to fit hoses with 8/10/13/19/25/32 mm diameter

Material : polypropylene



5084 COUPLING, "Guillemin", 2", threaded male

Specifications: Guillemin coupling with 2" threaded male (BSP)
Material : high tensile strength moulded aluminium alloy

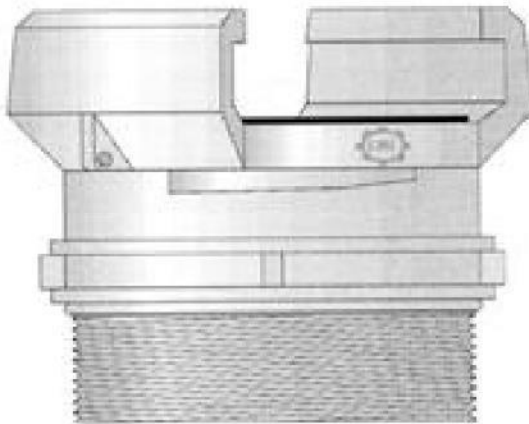

5085 COUPLING, "STORZ C" with 1" threaded male

Specifications: Storz C coupling with V' threaded male (BSP)
Material : high tensile strength moulded aluminium alloy



5086 COUPLING, "Storz C" with 1" threaded female

Specifications: Coupling Storz - C V' BSP threaded female
Material : high tensile strength moulded aluminium alloy



5087 COUPLING, "Storz C" with 2" threaded female

Specifications: Coupling Storz - C with 2" BSP threaded female
Material : high tensile strength moulded aluminium alloy



5088 COUPLING, "Storz C" with 2" threaded male

Specifications: Coupling Storz - C 2" BSP threaded male
Material : high tensile strength moulded aluminium alloy



5089 COUPLING, "Storz C", 1", threaded male

Specifications: Coupling Storz - C 1" BSP threaded male
Material : high tensile strength moulded aluminium alloy



5090 COUPLING, "Storz", REDUCER, B - C

Specifications: Adaptor Storz B - C
Material : high tensile strength moulded aluminium alloy



5091 COUPLING, BRASS, ADAPTER, internal thread 1" to hose tail 3/4"



5091a COUPLING, BRASS, ADAPTER, internal thread 1" to hose tail 1/2"

5092 COUPLING, BRASS, ADAPTOR, threaded male 1" to hose tail 1/2"



5093 COUPLING, CHROMED BRASS, 1/2" internal thread - 1" internal thread

5094 COUPLING, CHROMED BRASS, nipple 1/2"



5095 SEAL TAPE, PTFE ('Teflon'), for water connectors, roll 12mm x 12m

5096 COUPLING, COMPRESSION, BALL VALVE, for MDPE pipe d.ext 32mm

Compression fitting with ball valve to connect two 32mm MDPE pipes

Specifications: Compression fitting with ball valve for 32mm MDPE pipe

Material: Polyethylene or Polypropylen; resistant to chemicals/highly concentrated chlorine solutions (e.g. teflon sealing)



5097 COUPLING, COMPRESSION, ELBOW, 90deg, 32-32mm

Compression fitting to connect two 32mm MDPE pipes

Specifications: 90° Elbow compression coupling for 32mm MDPE pipe

Material: Polyethylene or Polypropylen; resistant to chemicals/highly concentrated chlorine solutions (e.g. teflon sealing)



5098 COUPLING, COMPRESSION, PLUG, for d.ext 32mm

Compression coupling for closing a 32mm MDPE pipe
Specifications: End plug for 32mm MDPE pipe
Material: Polyethylene or Polypropylen; resistant to chemicals/highly concentrated chlorine solutions (e.g. teflon sealing)



5099 COUPLING, COMPRESSION, SOCKET, for MDPE hose d. ext: 32mm

compression fitting to connect two 32mm MDPE pipes
Specifications: Compression fitting for 32mm MDPE pipe
Material: Polyethylene or Polypropylen; resistant to chemicals/highly concentrated chlorine solutions (e.g. teflon sealing)



5100 COUPLING, COMPRESSION, TEE, for pipe d. ext: 32mm

Compression fitting to connect three 32mm MDPE pipes
Compression fitting T 90° for 32mm MDPE pipe
Material: Polyethylene or Polypropylen; resistant to chemicals/highly concentrated chlorine solutions (e.g. teflon sealing)



5101 COUPLING, COMPRESSION, thread. male 1" to pipe d.ext 32mm

Compression fitting to connect one 32mm MDPE pipe with one 1" internal thread fitting
Specifications : thread adaptor 32mm compression - 1" BSP external thread
Material: Polyethylene or Polypropylen; resistant to chemicals/highly concentrated chlorine solutions (e.g. teflon sealing)



5102 COUPLING, COMPRESSION, DOUBLE CHECK VALVE, for MDPE pipe d.ext 32mm

Compression fitting with double check valve to connect two 32mm MDPE pipes
Specifications: Compression fitting with double check valve for 32mm MDPE pipe
Material: Polyethylene or Polypropylen; resistant to chemicals/highly concentrated chlorine solutions (e.g. teflon sealing)



**5103 COUPLING, COMPRESSION, REDUCER, for MDPE pipe d. ext:
32mm/25mm**

Compression fitting to connect a 32mm MDPE pipe to a 25mm MDPE pipe
Specifications: Compression fitting to connect a 32mm MDPE pipe to a 25mm MDPE pipe
Material: Polyethylene or Polypropylen; resistant to chemicals/highly concentrated chlorine solutions (e.g. teflon sealing)



5104 COUPLING, GALVA, ELBOW reduced 3" female 2" female

Specification: Elbow fitting 90° internal thread reduced, one end with 3" BSP internal thread, one end with 2" BSP internal thread.
Material: Galvanised pipe fitting made of malleable cast iron acc. international fitting normation ISO 49 and EN

5105 COUPLING, GALVA, NIPPLE, 1', threaded male/male

5106 COUPLING, GALVA, NIPPLE, 2", threaded male/male

5107 COUPLING, GALVA, REDUCER, 1" female - 3/4" female

Specifications: Reducer with V" female threaded BSP (ISO7) to 3/4" female threaded
BSP (ISO7)
Material : malleable cast iron

5108 COUPLING, GALVA, REDUCER, 1" male - 3/4" female

Specifications: Reducer with V" male threaded BSP (ISO7) to 3/4" female threaded
BSP (ISO7)
Material : malleable cast iron

5109 COUPLING, GALVA, REDUCER, 1" male - 3/4" male

Specifications: Reducer with V" male threaded BSP (ISO7) to 3/4" male threaded
BSP (ISO7)
Material : malleable cast iron

5110 COUPLING, GALVA, REDUCER, 2"-1", thread male/fem

5111 COUPLING, GALVA, REDUCER, 3"-2", threaded fem/male



5112 COUPLING, GALVA, REDUCER, 3"-2",thr fem/fem

5113 COUPLING, GALVA, SOCKET, 1", threaded fem/fem

5114 COUPLING, GALVA, SOCKET, 2', threaded fem/fem

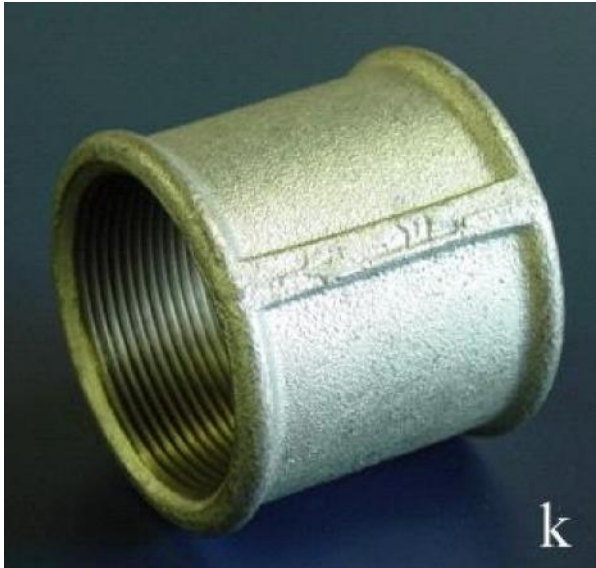

5115 COUPLING, GEKA, brass, 1" threaded female

GEKA Claw coupling for reversible connections of water hoses Specifications : GEKA coupling with 1" internal thread

Material : forged brass



5116 COUPLING, GEKA, brass, 3/4" threaded female

GEKA Claw coupling for reversible connections of water hoses Specifications : GEKA coupling with 3/4" internal thread

Material: forged brass



5117 COUPLING, GEKA, brass, 1" threaded male

Specifications : GEKA coupling with 1" external thread
Material : forged brass



5118 COUPLING, GEKA, brass, hose connection 1/2"

Specifications : GEKA coupling with 1/2" hose connection
Material : forged brass



5119 COUPLING, GEKA, brass, hose connection 3/4"

Geka clow coupling for reversible connections of water hoses
Axially rotatable 360°, prevents hose from twisting
Specifications : GEKA coupling with 3/4" hose connection
Material: forged brass



5120 Y-DISTRIBUTOR, GEKA, brass, with gate valve, 3/4"

Geka clow coupling for reversible connections of water hoses
Specifications : GEKA coupling with 3/4" hose connection
Material: forged brass



5121 VALVE, BRASS, BALL, 1" internal thread

Shut down valve, with ball type valve, diameter app. 25 mm
Specifications: Ball valve, 1/4 turn,
Both ends 1" BSP (ISO 7) internal thread

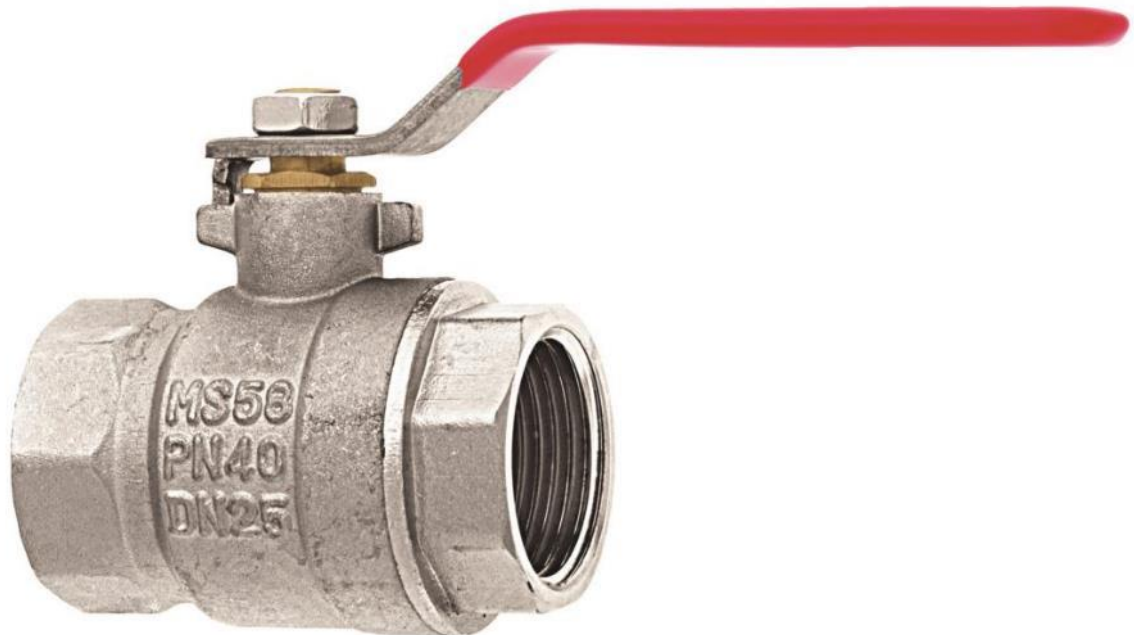

5122 COUPLING, PVC, ADAPTER, internal thread 1" to hose tail 22mm



5123 COUPLING, STORZ, T, PVC, 3x Storz C

Specifications: the adaptor consist of
- 1 x T-Fitting, 2" internal thread BSP
- 3 x Storz coupling C, external thread BSP
all parts are fitted together
Material : Fitting: PVC
Storz Couplings: high tensile strength moulded aluminium alloy

5124 HOSE, EPDM, flexible 3/4"

high-grade reinforced water- and cleaning hose, robust and long lasting
Lining : EPDM-rubber mixture
Reinforcements: plies made from high-grade corded fibres.
Cover : rubber resistant to mechanicalabrasion, weathering, oil and
grease
Inner diameter : 3/4 "

5125 HOSE, EPDM, flexible, 1 1/4", transparent

high-grade reinforced water- and cleaning hose, robust and long lasting

Lining : EPDM-rubber mixture
Reinforcements: plies made from high-grade corded fibres.
Cover : rubber resistant to mechanical abrasion, weathering, oil and grease
Inner diameter : 1 1/4 "

5126 HOSE, FLAT for delivery, Storz C, type fire brigade, 10m

Specifications: Heavy duty lay flat delivery hose according DIN14557,
Outside: synthetic woven textile reinforcement, resistance to oil and gasoline, abrasion resistant, flam-retardant.
Inside: encased in high tensile rubber.
Both ends are fitted with Storz C couplings

Temperature range -25°C up to + 60°C,
Operational pressure: 7bar, 8bar
Length: 10m



5127 HOSE, FLAT for delivery, Storz C, type fire brigade, 5m

Specifications: Heavy duty lay flat delivery hose according DIN14557,
Outside: synthetic woven textile reinforcement, resistance to oil and gasoline, abrasion resistant, flam-retardant.
Inside: encased in high tensile rubber.
Both ends are fitted with Storz C couplings

Temperature range -25°C up to + 60°C,
Operational pressure: 7bar
Length: 5m



5128 HOSE, flexible spiralled for suction, Storz C, type fire brigade, 2m

Specifications: Heavy duty reinforced suction hose according DIN14557
Cover: synthetic rubber, resistance to abrasion, heat and weathering.
Textile reinforcement with covered steel wire helix.
Inner tube: sythetic rubber
Both ends fitted with Storz C couplings Temperature range: -25°C up to +60°C
Operational pressure: 3bar
Length: 2 m

5129 HOSE, rubber, flexible, spiralled, Storz C, 1m

Specifications: Heavy duty rubber suction hose, reinforced with rubber covered metal spiral helix.
Both ends fitted with Storz C Couplings
Temperature range: -25°C up tu 60°C,
Operational pressure: 6 bar by 20°C,
Resistance to vaccum at 20 °C: 90%
Length: 1 m



5130 PIPE, MDPE polyethylene, d.ext: 32mm, NP10, coil, per meter

PE100 drinking water pipes. Resistant to acids, caustic substances, and organic and inorganic solvents. Good material strength and fatigue resistance.
Operating temperature range -40°C to +65°C.

5131 PIPE, MDPE polyethylene, d.ext: 25mm, NP10, coil, per meter

5132 PIPE, MDPE polyethylene, d.ext: 20mm, NP10, coil, per meter

5133 COUPLING, STORZ, GALVA, 3xStorz C with 2x ball valves

2" water distributor with two ball valves and three Storz C couplings

Specifications: 2" distributor with two ball valves and three Storz C couplings.
All parts are fitted together

Material: galvanised forged steel, malleable cast iron or high tensile strength moulded Aluminium

5134 JET PIPE, Storz C

Jet pipe for Spray and Branch

Jet Spray and Branch Pipe , Storz C

Material : high tensile strength moulded aluminium alloy

Norm :DIN 14365



5135 VALVE, BRASS, BALL 1/2", thr. fem x2, 1/4 turn steel handle

5136 VALVE, BRASS, BALL, 2" internal thread, Storz C

Shut down valve, size C with ball type valve, diameter app. 50 mm

Specifications: Ball valve, 1/4 turn,

Both ends 2" BSP (ISO 7) internal thread, fitted with Storz C coupling

Material: Storz Coupling: high tensile strength moulded aluminium alloy
Ball valve : brass, steel or aluminium

5137 PUMP, DIESEL, MAST NP4DH, Storz C

Self-priming centrifugal all-purpose pump, MAST NP4DH. Ready to use

Pumping rate: 550l/min

Pumping Head: 24m

Connection size: G 2", Storz C coupling

Engine: 4-stroke diesel Hatz 1B20

Supplied with spare part set and exhaust pipe



**5138 Pressure booster pump, 230V, 1000W, in PVC casing, outlet/inlet:
COUPLING, COMPRESSION, for MDPE PIPE d. ext: 32mm**

Mounted in a PVC casing (60 x 40 x 45 cm)

IP54

Enforced floor

Mains supply: 230V, 50 Hz

Power: approx. 1000 W

Delivery capacity: 3 cbm/h

Delivery height: 45 m

Power cord: 10 m, H05RN-F

with 2 GEKA couplings to fit 1" male thread

supplied with COUPLING, COMPRESSION, for MDPE PIPE d. ext: 32mm at outlet and inlet



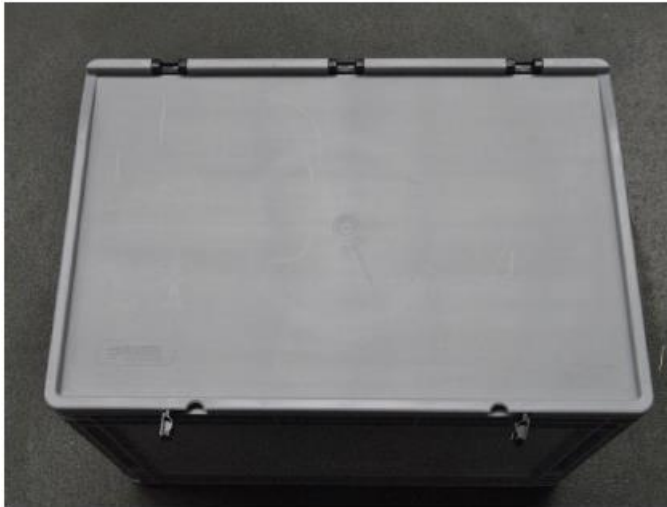

5139 FLY CATCHER, to hang up + attracting product

Specification :Fly trap made of an bag with pesticide free attractant and top cap which prevent flies to leave the trap.
Including in delivery : 2 spare bags with attractant



5140 MASK, dust protection, FFP2, disposable

Protective breathing mask, protection against solid and liquid aerosols Protection class : FFP2 according EN145



5141 Rapid Latrine

5142 SPRAYER, manual, back pack, 10l

Piston backsprayer, sturdy plastic or metal tank with 10 L filling capacity, pressure gauge, incl. 1 spare gasket; Nozzle: flat jet nozzle



5143 SPRAYER, manual, back pack, 20l

Piston backsprayer, sturdy plastic or metall tank with 15-20 L filling capacity, pressure gauge, incl. 1 spare gasket; Nozzle: flat jet nozzle



5144 SPANNER, ring type, for swivel fittings

5145 HOSE, hand shower hose, plastic

Hose for handheld shower head
Handshower hose. each end fitted with 1/2" internal thread fitting. Length : 2m
Material : plastic

5146 Shower head, handheld

Handheld Shower head with 1/2" external thread



5147 Washing and Rinsing field

Specifications : a set of three washtubes, size per washtub approx. 1,10 x 0,60 m

each washtube equipped with two water taps,
supply and drainage material
storage bowl / soap dish
paving tiles
Producer: deconta GmbH
Im Geer 20 46419 Isselburg
www.deconta.com

5148 **KIT, WATERTANK, flexible pillow, 5m3, transport/storage**

General information

Heavy-duty bladder tank; fitted on a flatbed truck or used as a normal storage tank.

The truck platform should be a minimum of 4m long by 2m wide.

Trucks with low body-panels on the sides, as opposed to an unprotected platform, are preferred.

Dimensions of the truck's platform should be equivalent to at least those of the empty tank.

The tank is fitted with heavy-duty 50mm polyester straps.

Specifications

Flexible tank: heavy-duty, for drinking water, quality PVC-coated polyester.

Specifically-designed for high-pressure resistance, for use on a tanker truck.

Threaded outlet:

- 2x3" BSP (International Federation ERU standard).
Fitted, at a minimum, with 2 heavy-duty polyester webbing straps, plus 2 straps per end.
Strap ends terminate with eyeholes and/or loops, used to secure the tank.
Anti-chafe patches.
Overpressure release valves with rubber plugs.
Dimensions:
- 5m³ tank: 4.45x2.21m or 4.50x2.60m (dependent on manufacturer).

Packaging as per IATA regulations UN1133 (for the glue) and UN1263 (for the thinner).

KWATTANKP05T Content list - [Export content list \(excel file\)](#)

Code	Description	Qty In Each	Total qty
EHDWBACLH050	BAND CLIP, for hose pipe, high torque, 50-70mm		2
KWATREPAF01 	KIT, REPAIR, for flexible tank PVC reinforced material		1
Code	Description	Qty In Each	Total qty
APACIATAC01	CONTAINER, IATA, for PVC flexible watertank repair kit	1	1
EHDWGLUENEO1	GLUE, neoprene contact, tube 120g	1	1
EHDWSANQPM12	SAND PAPER, dry/wet use, n.120, A4 sheet	1	1
EHDWTHINTR01	THINNER, trichlo-ethylene, 1L	1	1
WWAKREPAPVSH	SHEET, PVC, for flexible PVC watertank repair, 1 x 0.5m	1	1
WNECMCITG280I	FITTING GI, THREADED, HEXAGON NIPPLE M/M, DIAM2"		1
WNECSTCC2SH	COUPLING, "Storz", 2", hose tail		1
WNECSTCC2SM	COUPLING, "Storz", 2", threaded male		1
WNECSTCP2	COUPLING, "Storz", 2", plug with chain		2
WNEVBRGA2FF	VALVE, BRASS, GATE, 2", threaded fem/fem		1
WWAKFLPT05GS	(pillow tank 5m3) GROUND SHEET		1

Code	Description	Qty
WWAKFLPT05T	WATERTANK, flexible pillow, PVC, transport/storage, 5 m3	1
WWAKFLPT05TH	(pillow tank 5m3) HARNESS, for trucking	1

5149 Electric barrel pump, for Diesel, 230V

Electric barrel pump for pumping diesel oil, Category EL fuel oil, undiluted radiator antifreeze and other liquids of Hazard Category AIII (VbF).

Built-in siphon protection prevents leaks if the tube is faulty; filling nozzle with automatic shut-off; electronic volume readout with cumulative total and suitable for calibration

Specification:

- With manual suction pump
- VDE tested, motor with thermal protection switch
- Barrel thread M 64 x 4 and 2"
- Suction hose with filter 1.60 m length
- Pump hose made of Perbunan, 4 m length, with bend protection spring and pump nozzle



5150 DISINFECTION BASIN, 19L

Disinfection basin for boots

Material: Polyethylene

Specification : Resistant to chemicals/highly concentrated chlorine solutions; antislip floor

Volume: 19L

Dimensions: 80 cm x 60 cm x 11 cm (Length x Width x Height)



5151 BEAKER, POLYPROPYLENE OR PMP, 1000 ml

Graduated container to measure liquids
Material: Polypropylene or PMP (TPX)
Specification Beaker low form
Capacity 1000 ml, graduated
Packaging: Individually packed

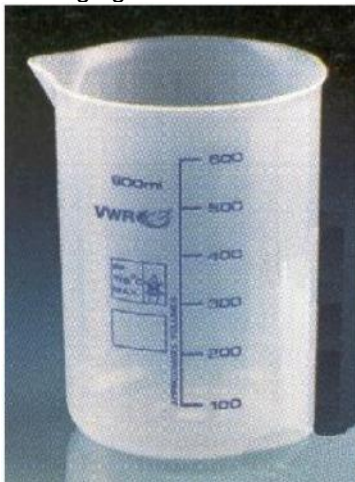

5152 BEAKER, POLYPROPYLENE OR PMP, 100ml

Graduated container to measure liquids
Material: Polypropylene or PMP (TPX)
Specification Beaker low form
Capacity 100 ml, graduated
Packaging: Individually packed

5153 SIGN “BIOHAZARD”, PVC, 125x150mm

Biohazard sign saying “ Caution Infectious waste”
Size: 125x150 mm
Material: rigid plastic (PVC) with self-adhesive back



5154 SIGN “NOT DRINKING WATER”, PVC, 125x150mm

Sign saying “Not drinking water”
Size: 125x150 mm
Material: rigid plastic (PVC) with self-adhesive back



5155 SIGN “HANDWASHING”, PVC, 125x150mm

Sign saying “Hand washing prevents disease”
Size: 125x150 mm
Material: rigid plastic (PVC) with self-adhesive back



5156 BAG, plastic for clinical waste, yellow

Safe disposal of clinical waste

Specifications : Waste bag for clinical waste, according UN3291. 60L

Colour : yellow

5157 Submersible electric dirt water pump, 230V, mounted in PVC casing, with adapter to fit 1" male thread

Used to pump off dirty water from the house, garden, ponds and wells. The infinitely variable float switch allows for continuous operation or a pre-selected ON and OFF switching level. Pump housing made of impact-resistant plastic. With carry-handle, high-quality ceramic seal for a long service life and a 90° angle for hose connection.

Specification:

Mains supply: 230V, 50 Hz

Power: approx. 780 W

Delivery capacity: 15000 L/h

Delivery height: 8 m

Immersion depth: 7 m

Size of foreign particles: up to 35 mm

Power cord: 10 m, H05RN-F

Dimensions (casing): approx. 60cm x 40cm x 45cm

Inlet: 2 x 1-1/4" (32 mm), PVC pipe, 1" female thread

Outlet: 1 x 1-1/4" (32 mm) PVC pipe, 1" female thread



5157a Submersible electric dirt water pump, 230V, with adapter to fit 1" male thread

Used to pump off dirty water from the house, garden, ponds and wells. The infinitely variable float switch allows for continuous operation or a pre-selected ON and OFF switching level. Pump housing made of impact-resistant plastic. With carry-handle, high-quality ceramic seal for a long service life and a 90° angle for hose connection.

Specification:

- Mains supply: 230V, 50 Hz
- Power: approx. 780 W
- Delivery capacity: 15000 L/h
- Delivery height: 8 m
- Immersion depth: 7 m
- Size of foreign particles: up to 35 mm
- Power cord: 10 m, H05RN-F
- Hose connection: adapter to fit 1" male thread



5158 Tripod, telescopic, steel

Heavy duty tripod to lift up to 2000kg with revolving eye for chain hoist and chain guard

Load-carrying capacity: 2000 kg

Dimensions: A = 2820-5000 mm, D = 2160-4050 mm (at 30 degree inclination of rods),
F = 4200 mm

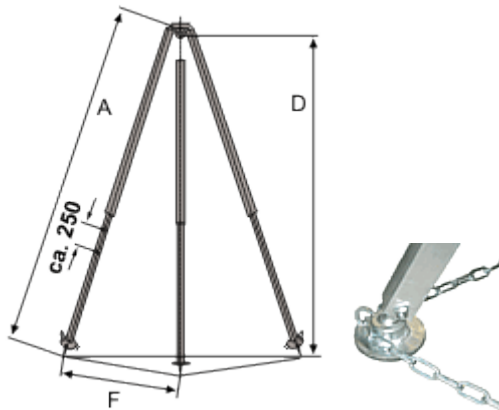

5159 Chain hoist, hand-operated for tripod (5156)

Heavy duty chain hoist to lift up to 2000kg, with overload protection (safety clutch), revolving hook and galvanized steel chain
Load-carrying capacity: 2000 kg
Dimensions: Height = 385 mm



5160 Lifting chain, 4-string, with security hooks

Heavy duty lifting chain to lift more than 2000kg
Chain size: 7 mm
Length L1: 1000 mm
Load-carrying capacity:

at >0-45 degree inclination 3150 kg



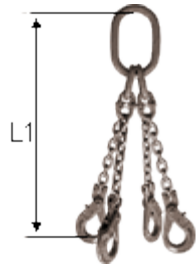

at >45-60 degree inclination 2240 kg



5161 Round sling, 5m, polyester

Heavy duty round sling to lift 2000kg
Total length: 5 m
Load-carrying capacity: 2000kg
Material: polyester

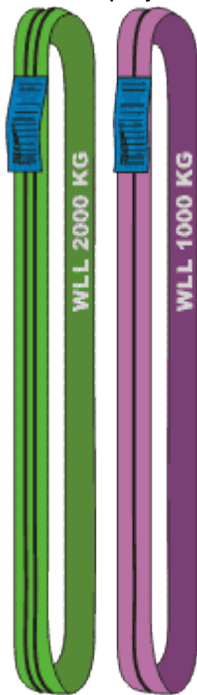

5162 RCD/400V warning label/sticker

Size: 5x10 cm

	<p>Achtung: FI-Schutz auf 400V CEE Stecker ist deaktiviert</p>
	<p>Attention: RCD protection on 400V CEE plug is deactivated</p>
	<p>Attention: Disjoncteur á 400V CEE prise de courant est désactive</p>
	<p>Atención: Disyuntor a 400V CEE toma de corriente se desactiva</p>

	<p>Achtung: FI-Schutz auf 400V CEE Stecker ist deaktiviert</p>
	<p>Attention: RCD protection on 400V CEE plug is deactivated</p>
	<p>Attention: Disjoncteur á 400V CEE prise de courant est désactive</p>
	<p>Atención: Disyuntor a 400V CEE toma de corriente se desactiva</p>

5163 Safety glasses, unisize



5164 GRC Safety vest, polyester, unisize, ISO 20471



5165 Welding bib apron, leather

REF. DESCRIPTOR
Specification



Heavy duty bib apron with adjustable neck and belt straps for incinerator operators
Size: 110x80cm/ 130x100cm



5166 HOLE SAW SET FOR WOOD, 25-68 mm

With 8 interchangeable inserts Ø 25-68 mm, with pilot drill Ø 6 mm, shank Ø 10 mm



5167 FIRST AID KIT "KITCHEN"

First aid kit for kitchens according to DIN 13157



5168 GN TRAY 1/1, 2,5l, 2 cm, stainless steel



5169 MEAT FORK, stainless steel, 52 cm

Meat fork for catering industry
Length: 52 cm



5170 CUTTING BOARD, plastic, 40x60x3cm

Cutting board for catering industry
Size: 40x60x3cm

Material: Polyethylen



5171 KITCHEN TABLE, stainless steel, 100 x 70 x H 84-115 cm, with height adjustable legs

Height adjustable kitchen table for catering industry
Size: 100 x 70 x H 84-115 cm
Material: stainless steel



5172 STRING LIGHTS, for 5 LED lamps, with 230V CEE 7/4 (Type F, Schuko) plug and hook, IP44, H05RNH2-F 2 x 1,5 mm², 16 m



5173 CONNECTOR, PVC, 1" female to female

1 inch
2-fold internal thread
Working temperature: constant up to 45 ° Celsius, 60 ° Celsius for a short time
Max. Working pressure: 10 bar



5174 HAND CART, metal, blue, with solid rubber tires

Loading area size: 1200 x 800 mm
Made of steel



5175 RCD tester, EN 61010-1: CAT III 600 V

Display	3 digits, backlight (blue and red)
RCD types	Normal or selective R
Voltage range	210 ... 240 V (neuter phase) 50/60 Hz
Alarm	Input voltage too high, lack of grounding and ground potential above 50 V
Environmental temperature	Operating: -15 ... +45 °C Storage: -25 ... +70 °C
Protection type	IP 40
Weight	340 g
Dimensions	71 x 210 x 51 mm
Power supply	4 x 1.5 V AA
Norms	EN 61010-1: CAT III 600 V EN 61557-6 EN 61236 (EMC)



5176 CABLE JUNCTION BOX, wall mount, 150x200x100 mm, IP65



5177 Adapter 400V/16A CEE female to 400V/63A male

specification: IEC 60309
with cord grip and cable bend protection certified by VDE and CE
protection classification : IP44



5178 COUPLING KEY, Storz C-B



5179 SIGN “No Access”, metal, round

Diameter: 400 mm
Material: metal



5180 SIGN “Use eye protection”, metal, round

Diameter: 200 mm
Material: metal



5181 SIGN “Use gloves”, metal, round

Diameter: 200 mm
Material: metal



5182 SIGN “Use face mask”, metal, round

Diameter: 200 mm
Material: metal



5183 SIGN “Use apron”, metal, round

Diameter: 200 mm
Material: metal



5184 BARREL INCINERATOR, 230V, with spare parts

Identical to Elastec SmartAsh

Construction: Stainless steel lid, Painted tubular steel frame
2-Blowers, Axial Vane 120v standard or 240v optional
Requires: 55 Gallon / 200 litre open head drum
Height: 46 inch / 1.17m
Floor Space: 36 x 26 inch / 0.91 x 0.66m with drum
Weight: 96 lbs / 44kg without drum, 139 lbs / 63kg with steel drum
Average Burn Rate: 50 lbs/hr / 22kg/hr (emission test data available upon request)
Power Consumption: .8 Kw/hr
14 amps start – 27 amps run (110v)
7 amps start – 14 amps run (220v)
Recommend a 20 amp breaker
Shipping Dimensions; Without Drum: 26 x 26 x 20 inch / 0.66 x 0.66 x 0.51m
including spare parts

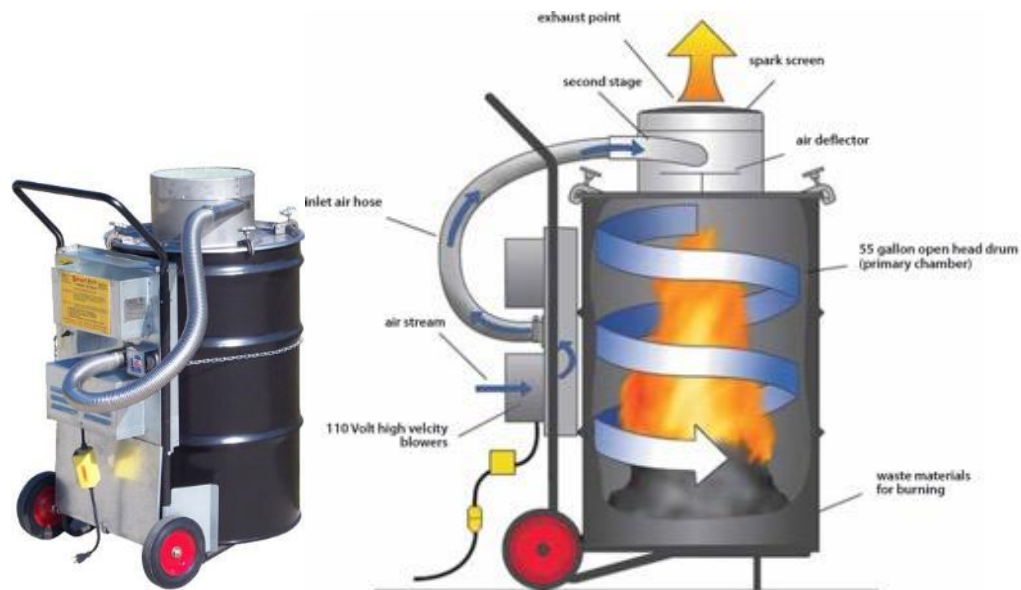

5185 HAMMER DRILL, 230 V, 780 W, with drill and chisel set

Technical details:

Power Input: 780 W

No Load Speed: 0 – 1100 min⁻¹

No Load Impact Rate: 0 – 4500 min⁻¹

Single stroke impact thickness: 2.4 J

Drilling Capacity in Concrete: 24 mm

Drilling Capacity in wood: 32 mm

Drilling Capacity in Steel: 13 mm

Chisel adjustment settings: 40x

Fixture: SDS-Plus Drill Bits

Dimensions (L x W x H): 370/84/214 mm

Weight: 2.9 kg



5186 WORKBENCH, foldable, metal

Dimensions: 840 x 1080 x 640 mm (height x length x width)

Working load: 500kg

Foldable workbench

Frame made of welded steel tubing

Wooden plate



5187 BENCH VISE, 100 mm, rotatable, with anvil

Heavy duty bench vice made from cast steel with rotating plate and hardened jaws with hammer finish lacquer blue
Jaws hardened, exchangeable 20 x 10 x 100 mm (H x W x D)
Screw distance 60 mm (centre screw to middle of screw head)
360 degrees rotatable base
Material: Cast Steel
With anvil 70 x 60 mm
Clamping width: 100 mm
Jaw Width: 100 mm
Clamp Depth 60 mm
Weight: 5.5 kg
Height: 138 mm



5188 SCREW CLAMP LM25/8

Opening (mm): 250 / Throat Depth (mm) 80 / Rail (mm): 20 x 5



5189 GENERATOR, 11kVA

Pramac P11000 with Yanmar engine or comparable

Fuel:	Diesel
Extras:	fuel pre filter
Starter:	electrical
Continuous power	
COP:	10 kVA/8 kW
Voltage	400 V / 50Hz
Protection:	automatic circuit breaker and residual current circuit breaker (ground fault circuit interrupter), emergency stop push switch
Outlets:	1 x CEE 400V 5p 16A IP44, 1 x CEE 230V 3p 32A IP44, 1 x CEE 230V 3p 16A IP44, 1 x CEE 230V 7/3 (Type F, Schuko) IP44 Terminal block for direct connection
Instruments:	oil pressure, temperature, hours, voltage, ampere and frequency
Noise reduction:	min. 70 dB (A) at 7 m
Canopy:	noise reduction canopy
Ambient temperature:	For diverse climate conditions
Spare parts:	10 x fuel filters, 10 x oil filters, 3 x air filters, 1 x fan belt
Additional:	mounted on chassis frame (with wheels) with Automatic Mains Failure (AMF) panel / Automatic Transfer Switch (ATS) with folding/demountable handle to fit on EURO palette (1200 x 800 mm)
12V starter battery:	maintenance-free, proof against deep discharge according to DIN 43 539 T5, trouble-free transport of operational blocks, no restrictions for rail, road, sea and air transport; shelve life up to 2 years without recharge due to the very low self discharge rate
Colour:	White
Fuel tank capacity:	24 L

5190 12V BATTERY CHARGER/JUMP STARTER

Connection/Frequency: 230 V ~ 50 Hz
Charging Voltage: 12 V
Load mains 200 – 1200 W
Charging current effective: 18 Amp.



5191 WATER PURIFICATION UNIT, 1m³/h at 100 NTU

Compact and easy to operate mobile water purification unit for sweet water meeting WHO drinking water regulations. Pre-packed and ready to use.

Structurally identical or equivalent to Berkefeld M1 (prototype developed by German Red Cross and Berkefeld/Veolia)

Based on maintenance-free ultrafiltration membrane technology suitable for longer storage periods (>4 years), for normal polluted and germ-contaminated surface or well water.

Capacity/Output: 1m³/h at 100 NTU

Materials: industrial grade; stainless steel, aluminium, PE pipework (no PVC pipes)

Packing: Small packing size, pre-packed in plywood boxes with metal handles (except skid-mounted filters), transportable on EURO pallets by airfreight in passenger planes according to IATA requirements

Quality standards for design/manufacturing:

- EU health and safety regulations
- DIN(EN)
- VDE(IEC)

Consisting of:

- 1 pcs Stainless steel membrane housing with ceramic UF module, activated carbon module and rack frame

Operation & Disinfection Module consisting of:

- 1x raw water inlet with D- connection coupling
with:
safety valve, ball valve and, pressure gauge
- 1x Pure water outlet with D-connection couplings
with:
1x Permeate membrane valve
1x Flow meter
1x proportional dosing unit Dosatron
1x Water meter
- 1 pcs 1x Pressure gauge
1x Sampling valve
- 1x Concentrate outlet with C connection coupling
with:
1x Concentrate membrane valve
1x Flow meter
1x Deaeration valve
1x Waste water outlet ball valve
- 1x Backwash water inlet C connection coupling
1x Backwash water inlet ball valve

- 1 pcs Activated carbon candle (spare)

- 2 pcs 5m, 2xD pressure hose

- 1 pcs 5m, 2xD transparent suction hose

- 4 pcs 5m, 2xC Suction hose black

2	pcs	1m, 2xC suction hose, black
1	pcs	5m, 2xC transparent suction hose
1	pcs	15m, 2xD pressure hose
1	pcs	1m, 2xD pressure hose
1	pcs	15m, 2xC pressure hose
1	pcs	Connection hose UF / O&D Module DN 25
1	pcs	Connection hose UF / O&D Module DN 40
1	pcs	Connection hose UF / O&D Module DN 40
1	pcs	CIP tank, 100l, blue, with "CIP tank" label on the outside, with liter measuring scale on the inside
2	pcs	holding braces
1	pcs	Ball valve CC
1	pcs	Inflow pipe 1D, for CIP tank
1	pcs	stream water distributor DDD
1	pcs	T-distributor DD
1	pcs	suction basket with check valve 1D
1	pcs	suction basket with check valve 1C, for CIP tank, 8mm mesh size
1	pcs	Y-Distributor, C - CC
5	pcs	Transition C-D
3	pcs	COUPLING, "Storz D" with 1" threaded female
3	pcs	COMPRESSION COUPLING, 1" male to 32mm
1	pcs	float
		dosing device with venturi nozzle DD, mounted on PVC plate with
	pcs	2x D-coupling
		1x venturi nozzle
		1x non return valve
		1x needle valve
		1x flow indicator
1		1x suction line
1	pcs	Dosatron spare part set
1	pcs	stirring paddle
1	pcs	Water meter DD
1	pcs	measuring cup 1000ml
2	pcs	measuring cup 100ml
4	pcs	pressure hose 2D-15m for flocculation line
1	pcs	Raw water pump DD, electric, 230V, IP44, Qnom = 4cbm/h
1	pcs	Pure Water pump CC, electric, 230V, IP44, Qnom = 4cbm/h
1	pcs	bucket, 17l
1	pcs	bucket, 10l, white, for CIP tank
1	pcs	5l jerry can, white with suction device for Dosatron (conducted trough cap)
1	pcs	wide outlet dosing tank with tamper (1x aluminum sulfate)
2	pcs	coupling key
1	pcs	Pipe wrench 50 mm
1	pcs	strap wrench

REF. DESCRIPTOR
Specification



1 pcs	hammer, 500gr
1 pcs	cross-tip screwdriver size 2
1 pcs	flat-headed screwdriver 9 x 150
1 pcs	allen key 5
1 pcs	allen key 6
1 pcs	allen key 8
6 pcs	O- Ring DN25, 33 x 3.53 mm
6 pcs	O- Ring DN40, 58 x 47 x 5.34 mm
2 pcs	O- Ring DN50, 70 x 60 x 5.34 mm
5 pcs	gasket Storz D
5 pcs	1-ear clamp d13.8
2 pcs	Hose clamp 59 - 63mm
2 pcs	hose clamp 37-40mm
2 pcs	teflon gasket strip
1 pcs	flat-headed screwdriver 4,5 x 90
1 pcs	O- Ring DN40, 58,74 x 3.53 mm
2 pcs	O- Ring DN40, 17,86 x 2,62 mm
2 pcs	O- Ring DN40, 43,82 x 5,34 mm
2 pcs	O- Ring DN25, 11,91 x 2,62 mm
1 pcs	O- Ring DN32, 37,69 x 3,53 mm
2 pcs	O- Ring DN25, 28,17 x 3,53 mm
2 pcs	ball seal, white, PTFE, 41,5 x 6 mm
2 pcs	ball seal, white, PTFE, 24,8 x 4,2 mm
2 pcs	Combination spanner for filter dome
1 pcs	DPD test tablets free chlorine (100pc)
1 pcs	Phenol red (100pc)
1 pcs	Measuring strips pH 0 - 14
1 pcs	pooltester pH/Cl2
1 pcs	turbidity tube, 3 parts

5192 4-WAY DISTRIBUTOR, for insulated air hoses

Material: metal

Inlet: 1 x 315 mm diameter

Outlet: 4 x 224 mm diameter

Total size: approx. 900 x 650 x 315 mm

Each outlet can be opened/closed with a handle

The distributor is made up of two parts which can be easily assembled

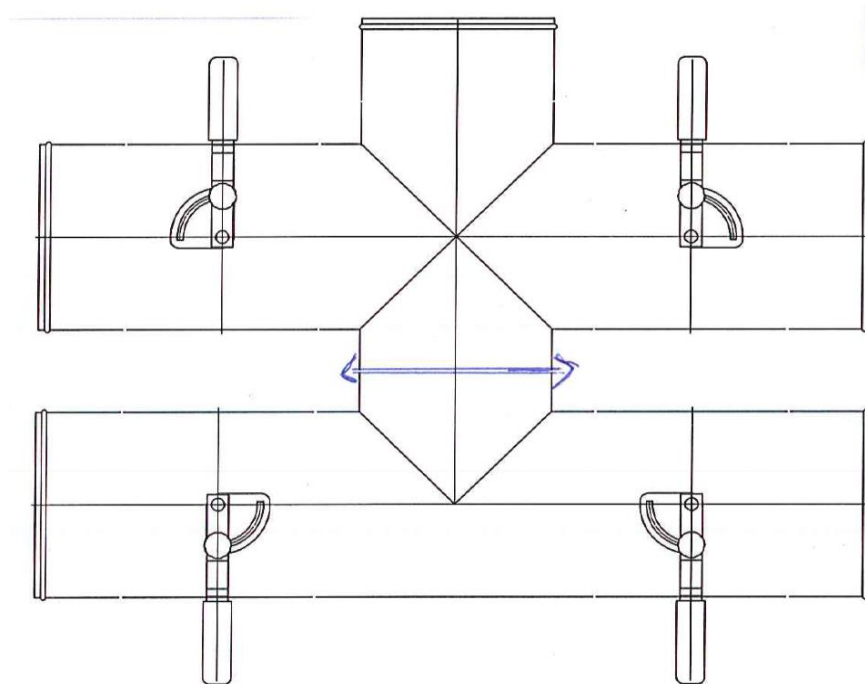

5193 PUMP, MAST NP12E, multi-purpose, 400V, CEE 16A 5-pole, Storz B

Self-priming centrifugal pump applicable for wastewater, light fuel oil, diesel fuel, and other non-aggressive liquids.

Specifics:

Self-priming from 8,4 m
with built-in non-return valve
maintenance-free
dry-running safe

Power:

3~ 400 V rotary current

engine power P1	4 kW
Rated current	7.3 A
Height H (max.)	20 m
Rate Q (max.)	1200 l/min

Delivery rate Q l/min	1200	1100	910	640	0
Delivery height H m (WC)	0	5	10	15	20

Fluids:

pH-range	5-8
density of medium max	1.1 kg/dm ³
temperature of medium to be pumped max	100 °C

Measures:

length	700 mm
width	490 mm
height	550 mm
weight	67 kg

Connections:

companion dimensions	G 2.5"
STORZ - coupler	B (inlet and outlet)
Solids passage	20 mm
connecting bend	H 07 RN-F 4G1,5 (1,5 m)
connecting plug	CEE 16 A 5-pole Starter plug with motor protection and on- /off-switch, phase sequence indicator and phase inverter

Materials:

pump body	Aluminium alloy acc. to DIN EN 1706*
blade wheel	Special cast iron acc. to DIN EN 1561
control device	Special cast iron acc. to DIN EN 1561
seals	Mineraloil resistant rubber Face seal carbon / carbid



5194 RAW WATER PUMP KIT, electric, floating, 400V/16A

Submersible pump with a mountable floating device

Pump: Grundfos SP 95-1 (MS6000T40 motor) or MAST T20 or comparable (delivery rate: approx. 1980 l/min at 5m height)

Power requirement: max. 5 - 5,5 kW

Pump outlet: Storz A

Additionally supplied with:

- 1 x Storz A-B coupling
- 1 x Storz B to 3" female coupling
- 1 x Storz A to 4" female coupling
- 1 x HOSE, flexible spiralled for suction, Storz A, type fire brigade, 1,6 m
- 1 x COUPLING, COMPRESSION, thread. male 4" to pipe d.ext. 90mm
- 1 x COUPLING, COMPRESSION, thread. male 4" to pipe d.ext. 110mm
- 2 x COUPLING KEY, Storz ABC
- 1 x HOSE, FLAT for delivery, Storz A, type fire brigade, 30m

Power supply/connector: H07RN-F 4G2,5; length: 40m; with CEE 16 A 5-pole plug incl. motor protection/circuit breaker with on / off switch (IP67)

Floating device components:

- dismantable or inflatable floating bodies/frame
- roller or chain to lift/lower pump (operated manually)



5195 WATER PURIFICATION UNIT, 4m³/h at 100 NTU

Compact and easy to operate mobile water purification unit for sweet water meeting WHO drinking water regulations. Works without electricity. Pre-packed and ready to use.

Structurally identical or equivalent to Berkefeld M4 light (old name: TWA 4 light)

Provided with glass beads filtration media (120kg SiLibeads FM FINE 0,50 – 1,00 mm, i.e. SiLibeads 4500510T) instead of sand

Capacity/Output: 4m³/h at 100 NTU

Materials: industrial grade

Packing: Small packing size, pre-packed in plywood boxes with metal handles (except skid-mounted filters), transportable on EURO pallets by airfreight in passenger planes according to IATA requirements

5196 DOSING DEVICE, for water purification unit 4m³/h at 100 NTU

Dosing device for chemicals (chlorine, aluminium sulfate, ...) to be used together with a water purification unit (4m³/h at 100 NTU); with hinges for filter frame mount

Supplied with English operating manual (hard and soft copy).

Inlet: Storz C

Outlet: Storz C

Materials: industrial grade

Packing: Small packing size, optimised for airfreight



5197 PALLET TRUCK, hand operated, double rollers, 2000kg lift capacity

For transportation of a loaded pallet inside a warehouse or to load trucks; appropriate on any hard surface.

Specifications:

- Standard size pallet trolley with a lift capacity of 2000 kg
- Fork length: 1150 mm
- Strong construction (heavy-duty steel), with painted iron
- Front wheels made of double articulated rollers, of strong synthetic material
- Double rear wheels
- Easy-to-operate lift pump and release handle
- Approved as safe by a reliable certification company specialized in lift-equipment safety
- Maintenance-free design with all connections lubricated for life



5198 PUMP, DIESEL, MAST NP12D, Storz B

Self-priming centrifugal all-purpose pump, MAST NP12D. Ready to use

Pumping rate: 1200l/min

Pumping Head: 28m

Connection size: G 2,5", Storz B coupling (inlet/outlet)

Engine: 4-stroke diesel Hatz 1B30

Supplied with spare spart set and exhaust pipe



5199 SUBMERSIBLE WATER PUMP KIT, electric, 230V, 50Hz

Pump: MAST TP 4-1 according to DIN 14 425 or comparable (delivery rate: approx. 400 l/min at 10m height)

Power requirement: max. 1,8 kW

Pump outlet: Storz B

Additionally supplied with:

- 1 x Storz B to 2 ½" female coupling
- 1 x Storz B to C coupling
- 1 x COUPLING, COMPRESSION, thread. male 2 ½" to pipe d.ext. 63mm
- 2 x COUPLING KEY, Storz ABC
- 1 x HOSE, FLAT for delivery, Storz B, type fire brigade, 20m
- 1 x 20 m work line with carabiner according to DIN 14 920 PA
- 1 x 230 V plug-in personal protection device with 1.5 m connection cable 3G1.5 mm² and Schuko plug IP 44 / Schuko coupling IP 67 and with on / off switch

Power supply/connector: H07RN-F 3G1,5; length: 20m; with CEE 7/4 (Type F, Schuko) plug IP67

5200 GENERATOR, 12kVA

Pramac P12000 with Hatz engine or comparable

Fuel:	Diesel
Extras:	fuel pre filter
Starter:	electrical
Continuous power	
COP:	12 kVA/9.6 kW
Voltage	400V/230V 50Hz
Protection:	automatic circuit breaker and residual current circuit breaker (ground fault circuit interrupter), emergency stop push switch
Outlets:	1 x CEE 400V 5p 32A IP44 1 x CEE 400V 5p 16A IP44 1 x CEE 230V 3p 16A IP44 1 x CEE 230V 7/3 (Type F, Schuko) IP44 Terminal block for direct connection
Instruments:	oil pressure, temperature, hours, voltage, ampere and frequency
Noise reduction:	min. 70 dB (A) at 7 m
Canopy:	noise reduction canopy
Ambient temperature:	For diverse climate conditions
Spare parts:	10 x fuel filters, 10 x oil filters, 3 x air filters, 1 x fan belt
Additional:	mounted on chassis frame (with wheels) with Automatic Mains Failure (AMF) panel / Automatic Transfer Switch (ATS) with folding/demountable handle to fit on EURO palette (1200 x 800 mm)
12V starter battery:	maintenance-free, proof against deep discharge according to DIN 43 539 T5, trouble-free transport of operational blocks, no restrictions for rail, road, sea and air transport; shelve life up to 2 years without recharge due to the very low self discharge rate
Colour:	White
Fuel tank capacity:	17-24 L